



Veraview  
IC5 HD



Thinking ahead. Focused on life.



# Veraview IC5 HD

## **High Definition Panoramic Imaging**

### **Industry Leading Exposure Time**

Extremely fast 5.5 second panoramic with significantly lower dose

### **High Definition**

Improved definition of 96  $\mu\text{m}$  (10 second scan) for the ultimate high definition image

### **Class-Leading Clarity**

DDAE (Digital Direct Auto Exposure) and AIE (Auto Image Enhancement) functions provide sharp and clear images

### **Quick and Easy Patient Positioning**

With integrated triple laser beam alignment

### **Fully Automatic Simplified Operation**

Simply select the desired program: Panoramic, TMJ or PEDO. In addition, no parameter setting is required

### **Digital Technology**

No film or film development are required

### **Low Power Consumption**

### **Lightweight and Compact Design**

# Select from two levels of speed and resolution

Depending on the diagnostic need, you can take a quick, 5.5 second panoramic for the lowest dose, or a 10 second scan for the ultimate, high resolution image.



## High Speed

With an industry leading exposure time of 5.5 seconds, the Veraview IC5 is not only significantly faster than conventional film-based panoramic systems, but also requires much less radiation.

High Speed: only 5.5 seconds, 192  $\mu\text{m}$ , 1/6\*\* X-Ray exposure

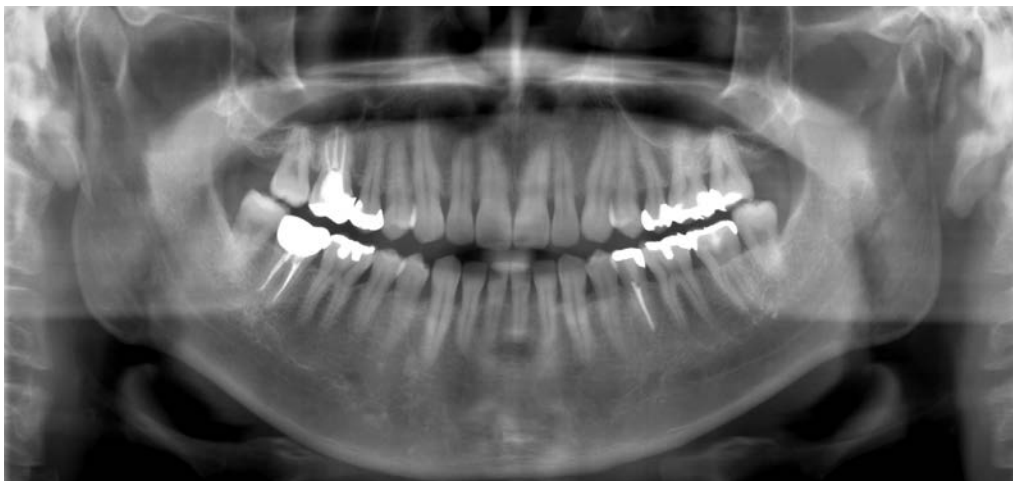

## High Definition

Pixel size is reduced 25% compared with the former model, so it produces superior images of a higher resolution.

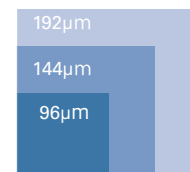

High Definition: 10 second exposure, 96  $\mu\text{m}$

High Speed: 5.5 seconds (192  $\mu\text{m}$ )  
High Definition: 10 seconds (96  $\mu\text{m}$ )

\*as of January 2010  
\*\*Compared to a standard panorama image using film and made by Morita's Veraviewepocs (16 seconds, 75kV, & 9mA)

The combination of DDAE (Digital Direct Auto Exposure) and AIE (auto image enhancement) produces high quality images with optimum contrast and uniform density.

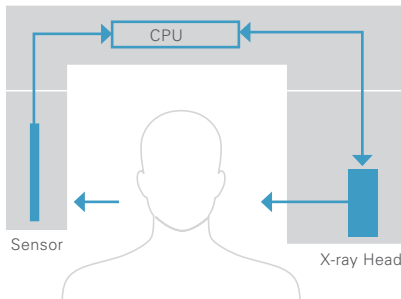

### Digital Direct Automatic Exposure (DDAE)

DDAE controls the X-ray tube current (mA) simultaneously by detecting X-rays passing through the patient. This improves the dynamic range, and, along with Automatic Exposure (AE), results in exceptionally clear images with the best possible contrast and even density. The automatic exposure level can be adjusted to meet your individual requirements.

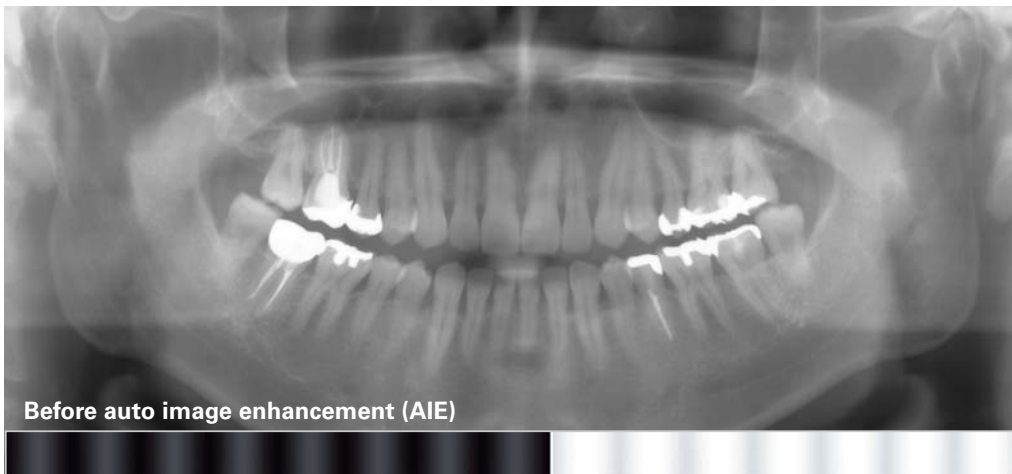

*Automatic Image Enhancer comparison*



### Automatic Image Enhancer (AIE)

AIE is a special software function that optimizes density throughout an entire image, and highlights the brightness level of detailed areas, to create images with an extremely high degree of clarity. DDAE and AIE perform a logarithmic conversion to produce the highest quality image possible.

# Panoramic



## Standard Panoramic

Clear, sharp images with a wide image layer. The thick, specifically designed image layer accommodates all possible variations of dental arch shapes and sizes to produce extremely clear and sharp images.

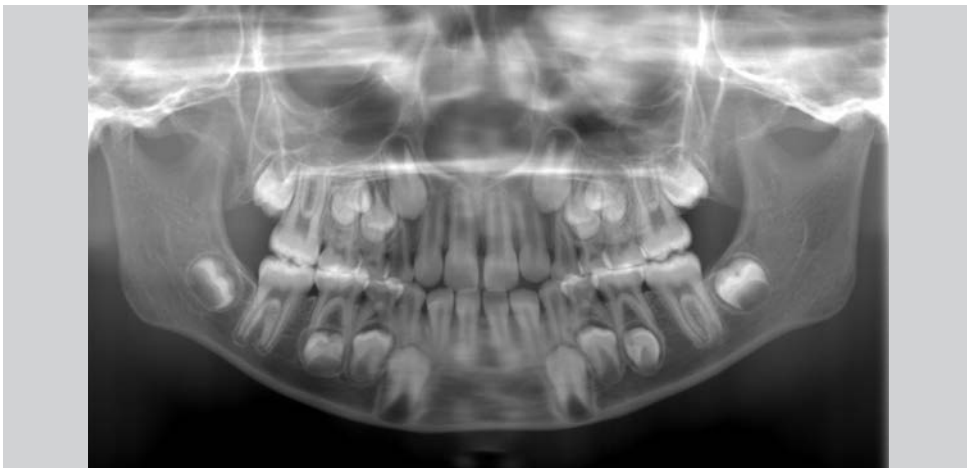

## Pedodontic Panoramic at Reduced Radiation

For examinations of children or people with small jaws, the rotation range of the arm is diminished, thereby further reducing radiation exposure.

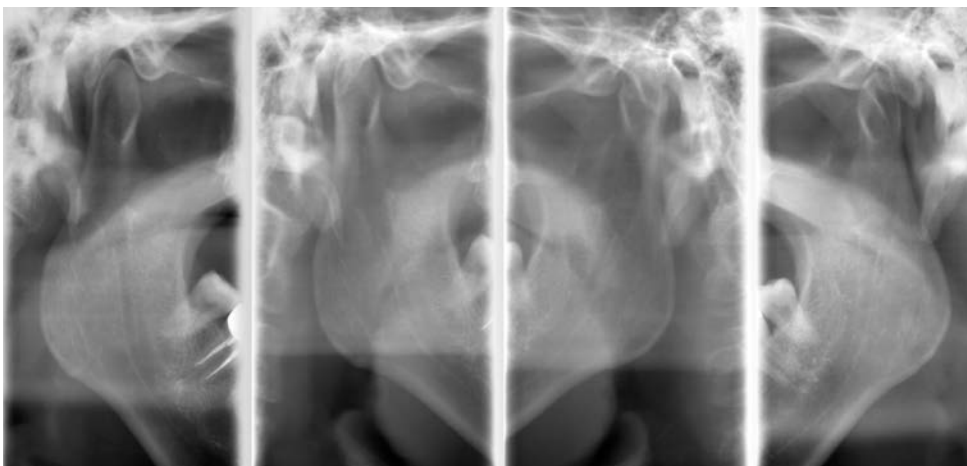

## TMJ Quadruple Exposures: for Open and Closed Condyle Views

Four separate shots of condyle fit onto one image. In each case, two sets of rotation for left and right condyle head for open and closed condition.

Clinical images provided by: Bruno Azevedo, DDS, MS, Oral Maxillofacial Radiologist; and Kitasenju Radist Dental Clinic, i-View Imaging Center, Japan.

# Specifications

<b>Trade name:</b>	Veraview IC5 HD
<b>Model:</b>	XDP1
<b>Input voltage:</b>	EX-1: AC 100V/115V/120V 50/60 Hz EX-2: AC 220/230/240V 50/60 Hz
<b>Power consumption:</b>	0.85 kVA
<b>Dimensions</b>	
<b>Main unit:</b>	W 880 x D 970 x H 2350 mm (2180 mm option) (W 35" x D 38-1/4" x H 92-1/2" (85-3/4" option))
<b>Weight:</b>	Approx. 110 kg (242.50 lbs)
<b>X-ray generator</b>	
<b>Tube voltage:</b>	60-70 kV (depending on exposure mode)
<b>Tube current:</b>	1-7.5 mA (depending on exposure mode)
<b>Effective focal spot:</b>	0.5 mm
<b>Panoramic image</b>	
<b>Exposure time:</b>	High speed mode: Approx. 5.5 sec. High definition mode: Approx. 10 sec.
<b>Imaging programs:</b>	Standard Panoramic Pedodontic Panoramic TMJ Quadruple Image

- Always have patients wear X-ray protective gear.

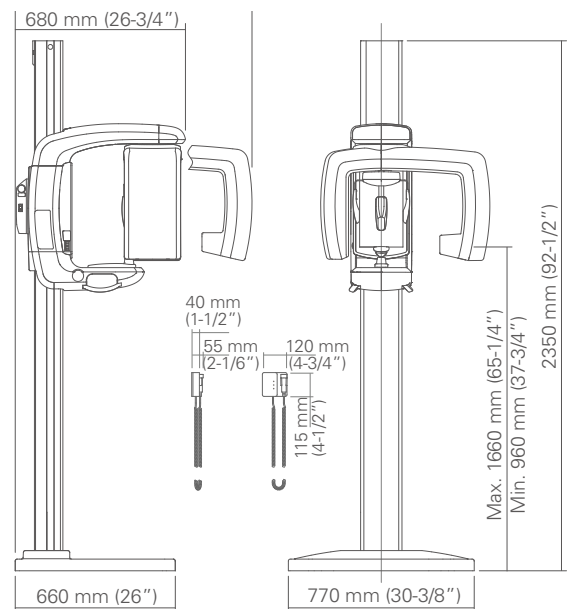

Small Base



Standard Base

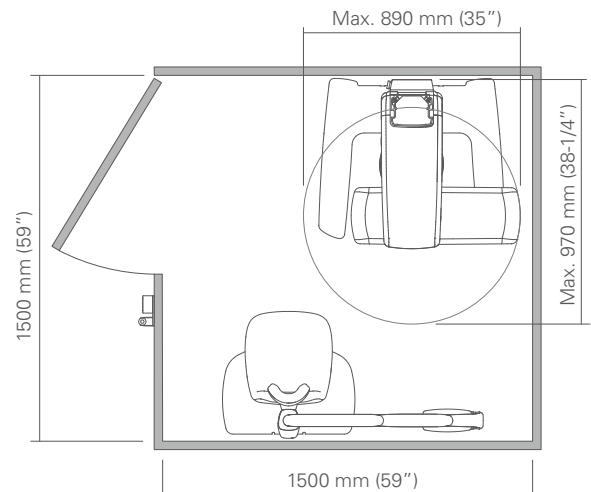



Development and Manufacturing  
**J. MORITA MFG. CORP.**  
680 Higashihama Minami-cho, Fushimi-ku,  
Kyoto 612-8533, Japan  
T +81. (0)75. 611 2141, F +81. (0)75. 622 4595

**Morita Global Website**  
[www.morita.com](http://www.morita.com)

Distribution  
**J. MORITA CORP.**  
3-33-18 Tarumi-cho, Suita-shi, Osaka 564-8650, Japan  
T +81. (0)6. 6380 1521, F +81. (0)6. 6380 0585

**J. MORITA USA, INC.**  
9 Mason, Irvine CA 92618, USA  
T +1. 949. 581 9600, F +1. 949. 581 8811

**J. MORITA EUROPE GMBH**  
Justus-von-Liebig-Strasse 27a, 63128 Dietzenbach, Germany  
T +49. (0)6074. 836 0, F +49. (0)6074. 836 299

**MORITA DENTAL ASIA PTE. LTD.**  
150 Kampong Ampat  
#06-01A KA Centre, Singapore 368324  
T +65. 6779. 4795, F +65. 6777. 2279

**J. MORITA CORP AUSTRALIA & NEW ZEALAND**  
Suite 2.05, 247 Coward Street, Mascot NSW 2020, Australia  
T +61. (0)2. 9667 3555, F +61. (0)2. 9667 3577

**J. MORITA CORP MIDDLE EAST**  
4 Tag Al Roasaa, Apartment 902, Saba Pacha 21311 Alexandria, Egypt  
T +20. (0)3. 58 222 94, F +20. (0)3. 58 222 96

**J. MORITA CORP INDIA**  
Felix Office No.908, L.B.S. Marg, Opp. Asian Paints, Bhandup (West), Mumbai 400078, India  
T +91-22-2595-3482

**J. MORITA MFG. CORP. INDONESIA**  
28F, DBS Bank Tower, Jl. Prof. Dr. Satrio Kav. 3-5, Jakarta 12940, Indonesia  
T +62-21-2988-8332, F + 62-21-2988-8201

**SIAMDENT CO., LTD.**  
71/10 Mu 5, Thakham, Bangpakong, Chachuengsao 24130, Thailand  
T +66. 38. 573042, F +66. 38. 573043  
[www.siamdent.com](http://www.siamdent.com)

Subject to technical changes and errors.

L-1497-0323

Diagnostic and Imaging Equipment

Treatment Units

Handpieces and Instruments

Endodontic System

Laser Equipment

Laboratory Devices

Educational and Training Systems

Auxiliaries