

TORX TR-9 INSTRUCTIONS FOR USE



TR-91
TR-91-O (with LED Light)



91 91LED



Thank you for purchasing the TORX TR-9.

For optimum safety and performance, read this manual thoroughly before using the TORX TR-9 and pay close attention to warnings and cautions. Keep this manual in a readily accessible place for quick and easy reference.

* Instruments (straight handpiece, contra angle, etc.) have separate user manuals. Be sure to read these manuals before using the instruments and follow all instructions and precautions.

Trademarks and Registered Trademarks :

The names of companies, products, services, etc. used in this manual are either trademarks or registered trademarks owned by each company.

The user (e.g., healthcare facility, hospital, clinic, etc.) is responsible for supervising the use and maintenance of medical devices. This instrument must not be used by anyone other than a dentist, doctor or other legally qualified professional.

Eligible Patients for the TORX TR-9:

Children to elderly who can stay still during treatment. A person's weight, gender, and nationality are not considered.

The TORX TR-9 must not be used for any purpose other than the provision of dental treatment.

The following symbols and expressions indicate the degree of danger and harm that could result from ignoring the instructions they accompany:

WARNING This warns the user of the possibility of serious injury or death to the patient, damage or complete destruction of the instrument or other valuable property, and fire.

CAUTION This warns the user of the possibility of slight or moderate injury to the patient.



This alerts the user of important points concerning operation of the instrument or the risk of damage to it.

Disclaimer

J. MORITA MFG. CORP. will not be responsible for the following matters, even during the warranty period.

- Repairs made by personnel not authorized by J. MORITA MFG. CORP.
- Any changes, modifications, or alterations of its products.
- The use of products or equipment made by other manufacturers, except for those procured by J. MORITA MFG. CORP.
- Maintenance or repairs using parts or components other than those specified by J. MORITA MFG. CORP. and other than in their original condition.
- Operating the product in ways other than the operating procedures described in this manual or resulting from the safety precautions and warnings in this manual not being observed.
- Workplace conditions and environment or installation conditions which do not conform to those stated in this manual such as improper electrical power supply.
- Malfunction or damage resulting from a natural disaster, such as a fire, earthquake, flood, or lightning.

The useful life of the TORX TR-9 is 7 years from the date of installation provided it is regularly and properly inspected and maintained.

In Case of Accident

If an accident occurs, this instrument must not be used until repairs have been completed by a qualified and trained technician authorized by the manufacturer.

For customers who use this device in the EU:

If any serious incident occurs in relation to the device, report it to a competent authority of your country, as well as the manufacturer through your regional distributor. Observe relevant national regulations for detailed procedures.

Standards and Procedures for the Disposal of Medical Devices

When disposing of this device, it should fall into the category of infectious waste.

The dentist or doctor must confirm that the device is uncontaminated, and must then have it disposed of by a healthcare facility or an agent licensed and qualified to handle standard industrial waste and industrial waste requiring special treatment.

Cautionary Remarks on Installation

Refer to the service manual and cable connection diagrams accompanying the equipment that the TORX TR-9 is connected to.

Operating, Transport and Storage Environments

Operating Environments

Temperature: +10°C to +35°C (+50°F to +95°F)
Humidity: 30% to 80% (without condensation),
Atmospheric Pressure: 70 kPa to 106 kPa

Transport and Storage Environments

Temperature: -10°C to +70°C (+14°F to +158°F)
Humidity: 10% to 85% (without condensation),
Atmospheric Pressure: 70 kPa to 106 kPa

* Do not expose the device to direct sunlight for an extended period of time.

* If the device will not be used for an extended period of time, store it in a clean, dry place after reprocessing it.

Parts Identification

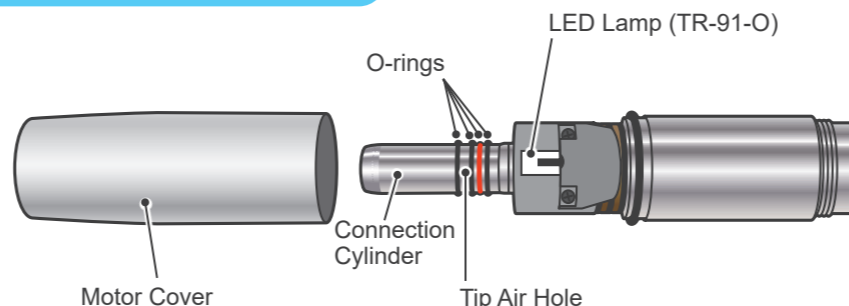

Accompanying Items

O-ring Set (Qty: 1)
(1 red, 3 blacks)



Code No. 5812385

Symbols

* Some symbols may not be used.



Serial number



Medical device



Unique device identifier



GS1 DataMatrix



Type B applied part



Refer to instructions for use



Autoclavable up to +135°C (+275°F)



Supports Washer-Disinfectors



Temperature limitation



Humidity limitation



Atmospheric pressure limitation



Fragile



Keep away from rain



This way up



Manufacturer



Date of manufacture



Importer



Distributor

12-3-4-5-6789012

Registration number of medical device in Thailand
(The 12-digit sample number shown is for demonstration purposes only.)



(Examples)

Country or region

(Country Names: Conforming to the ISO 3166-1 alpha-3 codes and EU for European Union)

Description noted next to the code is an indication that conforms to the regulations valid only for the relevant country or region.

Technical Specifications

* Specifications may be changed without notice due to improvements.

Generic Name	Dental Electric Motor	
Type	TR-91	TR-91-O
Light Source	N/A	LED
Indications for Use	This instrument is for polishing and drilling teeth and prosthetic devices.	
Operating Principle	The TORX TR-9 transduces electric energy into rotational power, and controls the motor rotation.	
Essential Performance	None (There is no unacceptable risk.)	
Degree of Protection against Electric Shock	Type B applied part	
Applied Part	Micromotor	
Rated Input Voltage	DC 24 ±2 V at maximum speed of rotation	
Water Spray Volume	50 mL/min or more at 0.2 MPa input pressure	
Tip Air Volume	6.0 NL/min or more at 0.38 MPa input pressure	
Cooling Air Volume	6.0 NL/min or more at 0.38 MPa input pressure	
Torque	3.0 N·cm	
Rotation Speed	100 ±40 rpm to 40,000 ±2,000 rpm	
Connection Figure	Conform to ISO 3964	
Connectable Handpieces	Conform to ISO 14457	
Total Length	Approx. 87 mm	Approx. 100 mm
Diameter	Approx. 22 mm	Approx. 22 mm
Weight	Approx. 85 g	Approx. 98 g

Electromagnetic Disturbances (EMD)

* The TORX TR-9 conforms to the relevant international standard for electromagnetic disturbances (EMD). For details, refer to the accompanying user manual for the dental treatment unit.

* Cable Length
Main Tube: 1.8 m

Service and Contacts

The TORX TR-9 may be repaired and serviced by:

- The technicians of J. MORITA's subsidiaries all over the world.
- Technicians employed by authorized J. MORITA dealers and specially trained by J. MORITA.
- Independent technicians specially trained and authorized by J. MORITA.

* For repairs or other types of service, contact your local dealer or J. MORITA OFFICE.

Development and Manufacturing

J. MORITA MFG. CORP.
680 Higashihama Minami-cho, Fushimi-ku, Kyoto 612-8533, Japan T +81. (0)75. 611 2141, F +81. (0)75. 622 4595
Morita Global Website www.morita.com

Distribution

J. MORITA CORP.
3-33-18 Tarumi-cho, Suita-shi, Osaka 564-8650, Japan
T +81. (0)6. 6380 1521, F +81. (0)6. 6380 0585

J. MORITA USA, INC.
9 Mason, Irvine CA 92618, USA
T +1. 949. 581 9600, F +1. 949. 581 8811

J. MORITA EUROPE GMBH
Justus-von-Liebig-Strasse 27b, 63128 Dietzenbach, Germany
T +49. (0)6074. 836 0, F +49. (0)6074. 836 299

MORITA DENTAL ASIA PTE. LTD.
150 Kampong Ampat #06-01A KA Centre, Singapore 368324
T +65. 6779. 4795, F +65. 6777. 2279

J. MORITA CORP. AUSTRALIA & NEW ZEALAND
Suite 2.05, 247 Coward Street, Mascot NSW 2020, Australia
T +61. (0)2. 9667 3555, F +61. (0)2. 9667 3577

J. MORITA CORP. MIDDLE EAST
4 Tag Al Roasaa, Apartment 902, Saba Pacha 21311 Alexandria, Egypt
T +20. (0)3. 58 222 94, F +20. (0)3. 58 222 96

J. MORITA CORP. INDIA
Felix Office No.908, L.B.S. Marg, Opp. Asian Paints, Bhandup (West), Mumbai 400078, India
T +91-82-8666-7482

J. MORITA MFG. CORP. INDONESIA
28F, DBS Bank Tower, Jl. Prof. Dr. Satrio Kav. 3-5, Jakarta 12940, Indonesia
T +62-21-2988-8332, F + 62-21-2988-8201

SIAMDENT CO., LTD.
71/10 Moo 5 T. Tharkham A. Bangpakong Chachuengsao 24130 Thailand
T +66 (0) 3857 3042, F +66 (0) 3857 3043 www.siamdent.com

Usage

Prohibitions

⚠️ PROHIBITION

- Do not use the TORX TR-9 on patients who have implanted pacemakers or defibrillators.
- No modification of the TORX TR-9 is allowed.
- Do not perform maintenance while using the TORX TR-9 for treatment.
- Do not use the wireless transmission devices listed below in the examination area:
 1. Mobile phones and smart devices
 2. Wireless transmitting devices such as ham radios, walkie-talkies, and transceivers.
 3. Personal Handy-phone System (PHS)
 4. Routers for intra-building paging systems, wireless LAN, cordless analogue telephones, and other electric wireless devices.
- The TORX TR-9 could be adversely affected by the electromagnetic radiation produced by electric scalpels, illumination devices etc. that are being used nearby.

Precautions

⚠️ WARNING

- To prevent infection, be sure to perform the handpiece reprocessing procedures after use with each patient.  **Reprocessing**
- Always wear personal protective equipment (PPE), such as safety glasses, gloves, a mask, etc. when using this handpiece.
- Before use, run the instrument outside the patient's oral cavity to make sure it rotates at the right speed and direction and it does not make an abnormal noise.
- Do not move the handpiece in and out the patient's oral cavity while the handpiece is running.
- Never connect or disconnect a handpiece while the micromotor is running. Otherwise, the patient could be injured or the micromotor or handpiece could be damaged.
- Do not shine the LED directly in the eye. This could impair one's eyesight.
- Stop using the instrument immediately if you feel the micromotor or handpiece or both is hot.
- Do not use the instrument if there is no cooling air, or not enough. Otherwise, the micromotor or handpiece or both might heat up considerably.
- Using the handpiece without the water spray could overheat and burn the treatment area.
- When a straight handpiece's chuck is open, the micromotor will lock up. If you continue to use the instrument under this condition, both the handpiece and the micromotor will heat up considerably. This could burn the patient and user, or damage the micromotor.
- If a worn handpiece is used, the micromotor or handpiece or both could overheat and burn the patient and user.
- If the micromotor stops running, have it inspected and repaired. Otherwise, if you try to run it by holding the foot control down, the micromotor could overheat and burn the user.

⚠️ CAUTION

- Always perform pre-use inspection before using the handpiece.  **1 Before Use**
- If the micromotor is used continuously for a long time, it could get hot enough to cause a low temperature burn. Stop using it immediately and wait for it to cool off.
- The geared-angle handpiece (CA-10RC-ENDO) cannot be connected to the TORX TR-9.
- Do not switch the rotation direction while the micromotor is running.
- Follow the bur manufacturer's recommendations for rotation speed and direction.

- ⚠️ Do not give the main tube a hard pull. This could break a wire or cause a short.

1 Before Use

* Be sure to perform reprocessing on the respective parts before using them for the first time.  **Reprocessing**

Before using the device, always check the following points.

- Make sure the handpieces (straight handpiece, contra angle, etc.) can be put on and taken off properly. Put them on and take them off 3 times each.
- Connect the handpiece to the micromotor, and then run the micromotor and pull the handpiece with the force that could be applied when in use. Make sure the handpiece does not come off.
 - * Do not attach a bur or point to the handpiece when you do this.
 - * Turn the tip air on and water spray off when you do this.
- Make sure the handpieces hold grinding tools securely.
- Without attaching the handpiece, run the micromotor alone at 40,000 rpm. Make sure it runs smoothly without making any abnormal noise. Also, make sure cooling air comes out of the connection cylinder, and tip air comes out of the tip air hole.
 - * Turn the water spray off when you do this.
- Without attaching the handpiece, run the micromotor alone at 40,000 rpm for 3 minutes and see if it feels like it heats up.
 - * Turn the tip air on and water spray off when you do this.
 Then, connect a handpiece to the micromotor and make sure nothing goes wrong when performing the same inspection.
 - * Turn both the tip air and water spray on when you do this.
- Connect a handpiece to the micromotor and run at 40,000 rpm. Make sure it runs smoothly without making any abnormal noise. Also, make sure water spray comes out in a fine mist, there is no water leaking from the micromotor joints, and the LED lights up properly.
- Make sure the tube connection ring for the micromotor is not loose.

If you find any abnormalities, stop using the micromotor immediately and contact your local dealer or J. MORITA OFFICE to have it repaired.

2 Micromotor Connection

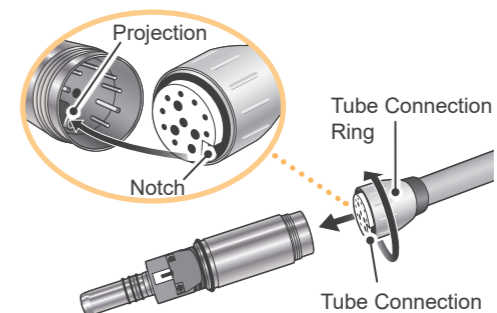

Line up the projection on the micromotor connection with the notch in the tube connection and slide the tube onto the micromotor. Then tighten up the tube ring securely.

- * For handpiece models with light capability, make sure that the tube connection color is white. For handpiece models without light capability, make sure that the tube connection color is brown.

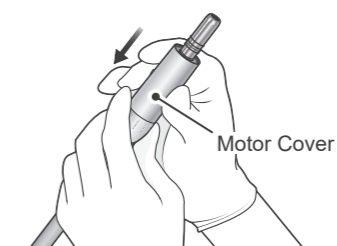

Slide the motor cover straight back on the micromotor.

⚠️ CAUTION

- After connecting the micromotor with the tube connection, make sure the tube connection ring is properly tightened. Otherwise, it could come off during use, or water and air might leak.

- ⚠️ Make sure that there is no dirt on the main tube connection. This could result in a malfunction.
- ⚠️ Handle the micromotor carefully. Do not drop it or bang it. This could deform the motor cover or impair the motor's operation
- ⚠️ Do not run the micromotor without its motor cover.
- ⚠️ Note that handpiece models with light capability can only connect to a tube with a white tube connection.

3 Connecting Handpiece

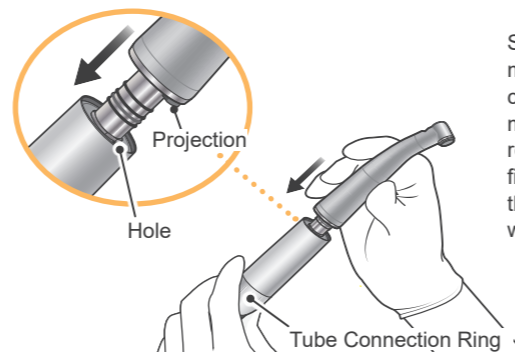

Slide the handpiece straight onto the micromotor's connection cylinder until it clicks securely into place. For handpiece models equipped with a light, slightly rotate the handpiece so that its projection fits in with the hole on the micromotor. If the projection and hole fit properly, there will be a clicking sound.

⚠️ WARNING

- Before using the handpiece, hold the tube connection ring and give the handpiece a light tug to make sure it is securely connected to the micromotor.
- Wait until the micromotor stops completely before connecting or removing the handpiece.

⚠️ CAUTION

- Always hold the tube connection ring to connect a handpiece. If you hold the motor cover, the handpiece may not lock in place securely.

- ⚠️ If handpiece insertion/removal becomes tight, apply a small amount of the LS OIL or MORITA MULTI SPRAY to the O-rings of the micromotor's connection cylinder. Wipe off any excess oil on the O-rings.
- ⚠️ Make sure the chuck for the straight handpiece is closed before connecting it to the micromotor.
- ⚠️ Always remove handpieces after use and at the end of the day to prevent maintenance oil from seeping into the micromotor and damaging it.

4 Disconnecting Handpiece

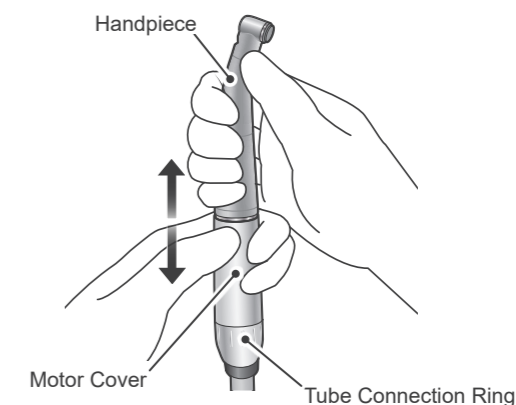

Hold the motor cover and pull the handpiece straight off.

Reprocessing

There are two ways to perform reprocessing depending on the items.

- Parts to be Sterilized
- Parts to be Disinfected

⚠ WARNING

- To prevent the spread of infections, be sure to perform the reprocessing procedures after use with each patient.
- Be careful to avoid cross infection when performing reprocessing.
- Always wear personal protective equipment (PPE) such as safety glasses, gloves, a mask, etc. when performing the reprocessing procedures.

⚠ CAUTION

- When performing reprocessing procedures, always turn off the dental treatment unit and make sure that the device will not operate.

- ❗ After use, perform reprocessing promptly. If the parts are left contaminated with blood, it will be difficult to remove.
- ❗ Be sure to remove the handpiece before reprocessing.

Preparation

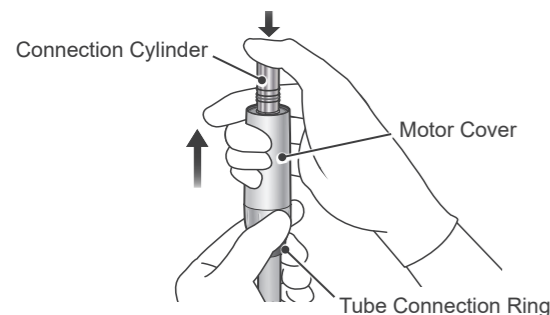

Holding the tube connection ring, grip the motor cover and press down on the connection cylinder with your thumb to slide the cover off the micromotor.

- ❗ Do not hold the main tube and pull the motor cover to take it off. This could break a wire or cause a short.

After Reprocessing

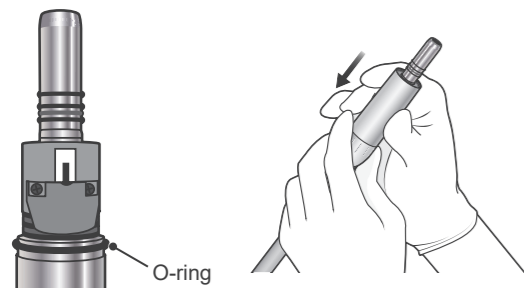

Apply a small amount of the LS OIL or MORITA MULTI SPRAY to the O-ring, and then slide the motor cover straight onto the micromotor. Plug it in until there is an audible click.

⚠ CAUTION

- Do not run the micromotor without its motor cover.

- ❗ If you do not oil the motor cover, it will be hard to put it on. Wipe off any excess oil on the O-ring and inside the motor cover.

Parts to be Sterilized



* Be sure to perform the reprocessing procedures promptly after use with each patient by following procedures 1 through 4.

1 Pre-treatment

This must be performed after use with each patient.

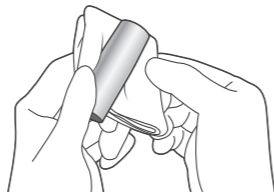

Wipe the parts with a piece of gauze or microfiber cloth (e.g., Toraysee for CE - Medical Equipment and Instruments Maintenance Cloth) that has been dampened with tap water to remove visible contaminants.

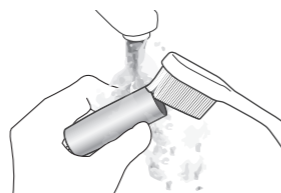

Alternatively, clean the parts in running water with a soft brush to remove visible contaminants.

- ❗ Do not use any chemicals that may coagulate proteins before cleaning.
- ❗ If a medical agent being used for the treatment has adhered to the part, wash it off under tap water.
- ❗ Do not clean the parts with an ultra sonic cleaning device.

3 Packaging

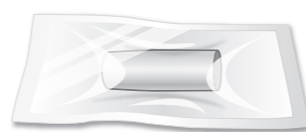

Place the motor cover in a sterilization pouch.

- ❗ Use sterilization pouches that conform to ISO 11607.
- ❗ Do not use any sterilization pouches that contain hydrosoluble adhesive ingredients such as PVA (polyvinyl alcohol). Note that even ISO 11607 conformable sterilization pouches may contain PVA.

2 Cleaning & Disinfection



Recommended Conditions for Washer-Disinfectors

Unit Name	Miele G7881
Mode	Vario TD
Detergent (concentration)	neodisher MediClean (0.3% to 0.5%)
Rinse (concentration)	neodisher MediKlar (0.03% to 0.05%)

- * After cleaning there may be streaks or white spots on the parts. Use a neutralizer only if there are streaks or white spots.

Put the motor cover in the parts washing basket.

Select the washer-disinfector's mode as shown in the chart above and start the process.

After completing the cleaning process, make sure the motor cover is thoroughly clean.

Expel remaining moisture on the surface or inside the motor cover with compressed air.

4 Sterilization



Recommended Autoclave Settings

Country : U.S.A.

Sterilizer Type	Temperature	Time	Drying Time after Sterilization
Gravity	+132°C (+269.6°F)	15 minutes	15 minutes
	+121°C (+249.8°F)	30 minutes	

Country : Other than U.S.A.

Sterilizer Type	Temperature	Time	Drying Time after Sterilization
Dynamic Air Removal	+134°C (+273.2°F)	3 minutes	10 minutes
	+134°C (+273.2°F)	5 minutes	
Gravity	+134°C (+273.2°F)	min.	min.
	+121°C (+249.8°F)	6 minutes	
		60 minutes	

Autoclave the autoclavable parts. After autoclaving, store the parts in a clean and dry environment.

⚠ WARNING

- If any moisture is left inside the motor cover after cleaning, it could cause corrosion or poor sterilization. Also, the remaining water may come out during use. After cleaning, use a syringe or compressed air to expel remaining moisture.

- ❗ Be sure to remove visible contaminants before this step. **1 Pre-treatment**
- ❗ Be sure to use washer-disinfectors that conform to ISO 15883-1 (must be capable of achieving disinfection values of not less than A₀ = 3000).
- ❗ If your region is susceptible to hard water scale buildup, use deionized water (ion-exchanged water).
- ❗ For details on handling detergents and neutralizers, concentration, water quality as well as parts washing baskets, refer to the accompanying user manual for the washer-disinfector.
- ❗ Inappropriate cleaning methods and solutions may damage the motor cover.
- ❗ Do not use strong acidic or alkaline chemicals that could cause the metal to corrode.
- ❗ After completing the cleaning process, expel remaining moisture inside the motor cover with compressed air.
- ❗ Do not leave the motor cover in the washer-disinfector. This may cause corrosion or malfunction of the parts.
- ❗ Surface of the motor cover may get scratched and worn out during the cleaning process due to contact with the parts washing basket or other parts. Replace the parts as necessary depending on degree of scratches and wear.
- ❗ Do not clean the micromotor.
- ❗ Do not drop or bang the motor cover. This could deform it. If it is deformed, there will be a gap between the cover and the handpiece and light or cooling air might leak out.

⚠ WARNING

- To prevent the spread of infections, the parts must be autoclaved after each patient's treatment has been completed.

⚠ CAUTION

- Parts are extremely hot right after autoclaving. Wait for them to cool off before touching.

- ❗ Do not sterilize the parts by any method other than autoclaving.
- ❗ If chemical solutions or foreign debris are not removed, autoclaving could damage or discolor the part. Thoroughly clean and disinfect the parts before autoclaving.
- ❗ The setting temperature for sterilization and drying process must be +135°C (+275°F) or lower. If the temperature is set at beyond +135°C (+275°F), it may cause a malfunction or stain on the parts.
- ❗ Do not autoclave any parts other than the motor cover.
- ❗ After completion of the autoclaving process, do not leave the motor cover in the autoclave.

Parts to be Disinfected

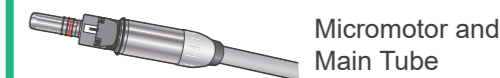

* Be sure to perform the reprocessing procedures promptly after use with each patient by following procedures 1 through 2.

1 Pre-treatment

This must be performed after use with each patient.

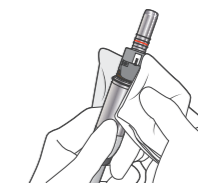

Wipe the parts with a piece of gauze or microfiber cloth (e.g., Toraysee for CE - Medical Equipment and Instruments Maintenance Cloth) that has been dampened with tap water to remove visible contaminants. Then wipe off moisture completely with a soft cloth.

⚠ CAUTION

- After handpiece lubrication, be sure to remove the excess oil. If any oil seeps inside the micromotor, it could result in a malfunction. Also, it may result in micromotor overheating causing a low-temperature burn. Refer to the user manuals for the handpieces for how to remove excess oil.

- ❗ Do not use any chemicals that may coagulate proteins before cleaning.
- ❗ If a medical or adhesive agent being used for the treatment has adhered to the part, immediately remove it with a piece of gauze or microfiber cloth (e.g., Toraysee for CE - Medical Equipment and Instrument Maintenance Cloth) that has been dampened with tap water.
- ❗ Do not clean the parts with an ultra sonic cleaning device.
- ❗ Do not wet the electrical contacts.

2 Cleaning & Disinfection

Wipe the part's surface with disinfectants approved by J. MORITA MFG. CORP.

Disinfectants Approved by J. MORITA MFG. CORP.

Disinfectant	Country
Ethanol (70 vol% to 80 vol%)	U.S.A.
Opti-Cide3 (wipes)	
FD333 forte (wipes)	Other than U.S.A.

- ❗ Make sure that there is no visible moisture and contamination when wiping the parts.
- ❗ Be sure not to tug on the main tube when you clean it. This could cause the wire to break.
- ❗ Be sure to lubricate the O-rings after cleaning the surface of the connection cylinder and the O-rings. Lack of lubricant will damage the O-rings and the motor cover will be hard to remove and air or water might leak.
- ❗ Do not use disinfectants other than those designated by J. MORITA MFG. CORP.
- ❗ For details on handling disinfectants, refer to the accompanying user manual for each disinfectant.
- ❗ If too much disinfectant is applied to the piece of gauze or microfiber cloth, it will seep into the part and cause a malfunction.
- ❗ Do not immerse the parts in or wipe them with any of the following: functional water (acidic electrolyzed water, strong alkaline solution, and ozone water), medical agents (glutaral, etc.), or any other special types of water or commercial cleaning liquids. Such liquids may result in metal corrosion or adhesion of the residual medical agent to the parts.
- ❗ Do not clean or immerse the parts with chemicals such as formalin cresol (FC) and sodium hypochlorite. These will damage the metal and plastic parts. Immediately wipe away any chemicals that are accidentally spilled on the parts.

Troubleshooting

If the TORX TR-9 does not seem to be working properly, first inspect the points described below. Before inspection and adjustment, check to see if the main switch of the device, such as a dental treatment unit that the handpiece is connected to, is turned on and if the main air and water valves are open.

* For repair or other types of service, contact your local dealer or J. MORITA OFFICE.

Problem	Check Points	Remedies
Micromotor does not run.	Check micromotor main tube connection.	Check micromotor connection. 2 Micromotor Connection
	Remove the handpiece from the micromotor and step on the foot control. Does the micromotor run?	If the micromotor starts running, the handpiece requires inspection and repair. If the micromotor still does not run, see Check Point (1)
	(1) Step on the foot control and bend or twist the main tube slightly near the tube connection ring. Does the micromotor run?	If the micromotor runs sometimes, wiring inside the main tube is breaking. Have the main tube inspected and repaired. If the micromotor does not run at all, have the micromotor and dental treatment unit inspected and repaired.
No water is emitted.	Check that the dental treatment unit's handpiece water switch is turned on. Check that the dental treatment unit's spray adjustment knob is open.	Turn the dental treatment unit's handpiece water switch on. Open the dental treatment unit's spray adjustment knob.
	Remove the handpiece from the micromotor and step on the foot control. Does water come out of the motor joint?	If water comes out, see Check Point (2) and (3). Then reconnect the handpiece and check that water comes out of the handpiece. If water does not come out, have the handpiece inspected and repaired. If water does not come out of the micromotor, see Check Point (4).
	(2) Check the connection cylinder's O-rings are properly installed.	If you find any damaged or worn-out O-rings, replace them with new ones. O-ring Replacement
	(3) Check that the spray hole(s) is not clogged.	Clean the holes for air and water on the handpiece.
Water leakage	Check micromotor tube connection and handpiece connection.	Check micromotor and handpiece connections. 2 Micromotor Connection 3 Connecting Handpiece
	Are the O-rings on the connection cylinder worn out or damaged?	Replace all O-rings on the connection cylinder. O-ring Replacement
LED does not work.	Check that the dental treatment unit's handpiece light switch is turned on.	Turn the dental treatment unit's handpiece light switch on.
	Check handpiece connection.	Check handpiece connection. 3 Connecting Handpiece
	Does the micromotor have a LED lamp?	Use micromotors equipped with a LED lamp.
	Does the handpiece have a light?	Connect handpiece equipped with a light.
LED does not work.	Check that the LED lamp has not burned out.	Replace the LED lamp. LED Lamp Replacement If it still does not work, have the dental treatment unit inspected and repaired.

Replacement Parts

* Replace parts as necessary based on the degree of wear and length of use.

* Order parts from your local dealer or J. MORITA OFFICE.

O-ring Replacement

Consumables

O-ring Set (1 red, 3 blacks)

Code No.5812385



* The O-rings on the connection cylinder wear out after a while, and this leads to air and water leakage. Replace all 4 O-rings at the same time. Make sure the red O-ring is in the right place.

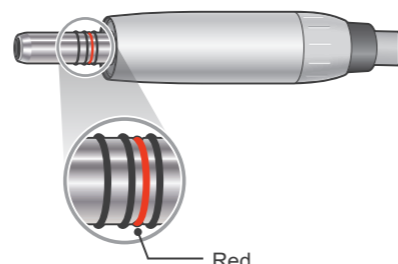

Remove the O-rings with tweezers or another such tool and install the replacements. Make sure that the red O-ring is in the right place.

After the replacement, apply a small amount of the LS OIL or MORITA MULTI SPRAY to the O-rings. Wipe off any excess oil on the O-rings.

- Use only O-rings that have been designed specifically for use with the device.
- If the red O-ring is not in the right place, air or water or both could start to leak.

LED Lamp Replacement

Consumables

LED Lamp

Code No.5011575



* Replace the LED lamp when it stops lighting up.

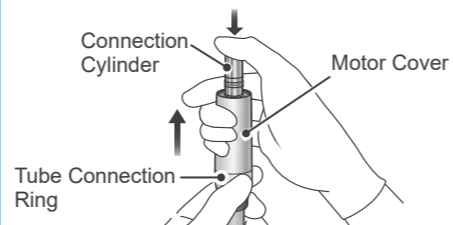

Holding the tube connection ring, grip the motor cover and press down on the connection cylinder with your thumb to slide the cover off the micromotor.

- Do not hold the main tube and pull the motor cover when you do this. This could break a wire or cause a short.

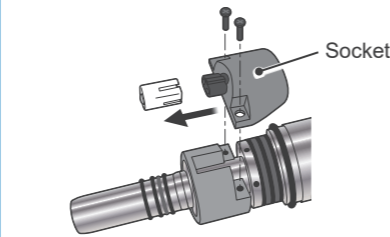

Take the 2 screws out of the socket to remove it. Take the old LED light out of its socket.

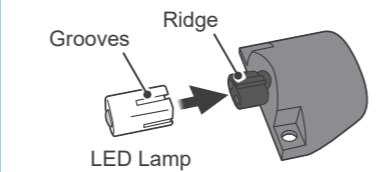

Line up the groove in the new LED with the ridge on the socket and push the LED onto the socket.

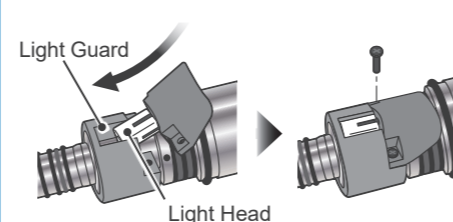

Replace the socket so that the light head goes up the light guard and then secure it with the two screws.

Slide the motor cover back on until it clicks into place.

Regular Inspection

* Regular inspection is generally considered to be the duty and obligation of the user, but, if, for some reason, the user is unable to carry out this duty, this may be performed by the accredited service personnel. Contact your local dealer or J. MORITA OFFICE for details.

* The TORX TR-9 should be inspected every 3 months in accordance with the following regular inspection items.

* For repair or other types of service, contact your local dealer or J. MORITA OFFICE.

* J. MORITA MFG. CORP. will offer replacement parts and service for the product for a period of 10 years after the manufacturing of the product has been discontinued. Replacement parts and service will continue to be available during that period.

Regular inspection items

Inspection Item	Check Point
1 Micromotor Connection	Check that the tube connection ring for the micromotor is not loose.
2 Handpiece Connection	Connect a handpiece and run the motor, and then pull the handpiece with a force similar to that applied during treatment to see that the handpiece does not come off. Test this three times.
3 Micromotor Rotation and Spray	Run the micromotor at maximum speed without a handpiece and check the following points. <ol style="list-style-type: none"> 1. The rotation is smooth with no abnormal noise. 2. The cooling air is coming out from the connection cylinder.
	Connect a handpiece and run the micromotor at maximum speed to check the following points. <ol style="list-style-type: none"> 1. The rotation is smooth with no abnormal noise, and the spray has a fine, misty consistency. 2. There is no air or water leakage at the handpiece or main tube connections. 3. The LED lamp turns on. (Only for models with light capability.)
4 Overheating	Run the micromotor without connecting a handpiece at maximum speed for 3 minutes and check if it feels abnormally warm. Connect a handpiece to the micromotor and check the same as above.

TERMS AND CONDITIONS

J. MORITA MFG. CORP. warrants the Product as follows:

1. Warranty Term.
J. MORITA MFG. CORP. warrants that the Product will be free from defects in materials and workmanship for 12 months.
2. Items Not Covered by Warranty.
This Warranty will not cover parts of the Product or consumables which normally need to be replaced such as glass or rubber components, lamps, cartridge, ball bearings and the like. Further, this warranty will not cover defects or damage caused by:
 - a. Failure to operate or use the Product in accordance with the Operation Instructions or warning/cautionary labels.
 - b. Modifications of the Product, connecting the Product to other products, or using components or replacement parts not specified or approved by J. MORITA MFG. CORP.
 - c. Repairs performed by parties not designated by J. MORITA MFG. CORP.
 - d. Accidents or forces outside of J. MORITA MFG. CORP.'s control, such as dropping the Product or collision of the Product with other objects, fire, flood, natural disaster, etc.
 - e. Use or operation of the Product in settings or under conditions not specified by J. MORITA MFG. CORP. or set forth in the Operation Instructions including, without limitation, unauthorized changes in equipment settings, connection to unauthorized devices.
3. Remedies of Customer.
Customer must present this Warranty when claiming coverage or application thereof, and either ship or deliver the Product to an authorized location of J. MORITA MFG. CORP. or its subsidiaries or authorized dealers. Upon receipt and verification of this Warranty, inspection of the Product, and determination of coverage by this Warranty, J. MORITA MFG. CORP. will, at its sole option, supply the parts or components either replaced or repaired free of charge to the Customer. Delivery and shipping charges are the responsibility of the Customer.
4. LIMITATIONS AND EXCLUSIONS FROM WARRANTY.
The remedy set forth in paragraph 3 is the sole and exclusive remedy of Customer. J. MORITA MFG. CORP. MAKES NO OTHER EXPRESS OR IMPLIED WARRANTIES AND SPECIFICALLY EXCLUDES ALL OTHER WARRANTIES INCLUDING, WITHOUT LIMITATION, ANY IMPLIED WARRANTIES OF MERCHANTABILITY OR FITNESS FOR A PARTICULAR PURPOSE. IN NO EVENT SHALL J. MORITA MFG. CORP. BE LIABLE FOR ANY INCIDENTAL OR CONSEQUENTIAL, DIRECT OR INDIRECT, OR SPECIAL DAMAGES OF ANY KIND INCLUDING, WITHOUT LIMITATION, DAMAGES FOR LOSS OF REVENUE, LOSS OF BUSINESS OR BUSINESS OPPORTUNITY, OR OTHER SIMILAR FINANCIAL LOSS ARISING OUT OF THE PERFORMANCE, USE OR INTERRUPTED USE OF THE PRODUCT.
5. Repairs Not Covered by Warranty.
With respect to repairs not within the period of this Warranty or otherwise not covered by this Warranty, J. MORITA MFG. CORP. will perform the same, timely, efficiently, and for an appropriate cost.

12 Months