



Dental Treatment Unit

Spaceline EMCIA

Type PdW (CU-580-UP)

INSTRUCTIONS FOR USE

Thank you for purchasing the dental treatment unit

SPACELINE EMCIA TYPE PdW

or

SPACELINE EMCIA TYPE PdW (FT)

For optimum safety and performance, read this manual thoroughly before using the unit and pay close attention to the warnings and notes.

Keep this manual in a handy place for ready reference.

Trademarks (™) and Registered Trademarks (®):

The names of companies, products, services, etc. used in this manual are either trademarks or registered trademarks owned by each company.

© 2012 J. MORITA MFG. CORP.

Table of Contents

	Page
PREVENT ACCIDENTS	3
Disclaimer	4
Warnings and Prohibitions	5
Safety and Accident Prevention for the Operation of Electrical Medical Devices	6
Parts Identification and Accessories	7
1. Parts Identification and Warning Labels	7
2. Accessories	13
Operation	14
1. Preliminaries	14
(1) Turn Main Switch On	14
(2) Main Water and Air Valves	14
(3) Flush Out Cleanser	15
(4) Inspect Before Use	15
2. Operation Instructions	16
(1) Chair Operation	16
(2) Headrest	24
1) Natural Movement	24
2) Ratchet Type	25
3) Slide Type	26
4) Two-axle Type	27
(3) FT Arm Rest, Doctor's Side	29
(4) Instrument Tubes	30
(5) Switch Lamps and Displays	32
(6) Air Turbine Handpiece	33
(7) Micromotor Handpiece: TORX (TR-S2 series) or Air Torx	37
(8) Threeway Syringes	43
1) Threeway Syringe	43
2) Threeway Syringe (with light) (option)	45
(9) Vacuum Syringe	48
(10) Basin	50
(11) Snap-On Tube Connections (drain connector is an option)	53
(12) Saliva Ejector (option)	55
(13) Assistant Instrument Holder (option)	56
(14) Assistant's Auxiliary Tray (option)	57
(15) Small Tray (option)	57
(16) PdW Tray	58
(17) Dental Operating Light: Luna Vue LD	63
(18) Ultra Sonic Scaler: Solfy F (Built-in Model) (option)	65
(19) Water Line Flushing System	68
3. After Use	83
(1) Turn Main Switch Off	83
(2) Close main water and air valves	83

	Page
Sterilization, Parts Replacement and Storage	84
1. Sterilization.....	84
(1) Autoclavable Components and Instruments.....	84
(2) Components Disinfected by Wiping with Ethanol for Disinfection (Ethanol 70 vol% to 80 vol%)	85
2. Regular Maintenance.....	86
(1) Daily Before Use.....	86
(2) Between Patients	87
(3) Everyday After Use.....	89
(4) Once a Week.....	92
(5) Once a Month.....	94
(6) Once Every Six Months	96
(7) Once a Year	100
3. Replacement Parts	102
(1) LED Lamp Replacement for Air Turbine Handpieces (with light) (option)	102
(2) O-ring Replacement for Air Turbine Handpieces.....	104
(3) Replacing the Lamp Cartridge for the Threeway Syringe (with light) (option).....	105
(4) Clean Spittoon Valve.....	106
(5) Amalgam Separator.....	107
(6) Combi Separator.....	107
4. Storage.....	107
Maintenance and Inspection	108
Regular Inspection	108
Troubleshooting	111
1. Chair	111
2. Air Turbine Handpieces.....	111
3. TORX (TR-S2 series).....	113
4. Torx Air Motor	115
5. Threeway Syringe.....	116
6. Vacuum Syringe.....	117
7. Basin.....	117
8. Auto Cup Filler.....	118
9. Luna Vue LD Light.....	118
10. Water Line Flushing System	118
Technical Specifications	119
Specifications	119
Userbility Statement.....	120
Symbols.....	121
Service and Other Contacts	122
Alert Indicators	122
Electromagnetic Disturbances (EMD)	123

* This manual covers a fully equipped model; refer to the sections covering the instruments and functions of your own unit.

ATTENTION CUSTOMERS

Do not fail to receive clear instructions concerning the various ways to use this equipment as described in this accompanying Manual.
Fill out and sign the warranty and give the dealer from whom you purchased the equipment his copy.

ATTENTION DEALERS

Do not fail to give clear instructions concerning the various ways to use this equipment as described in this accompanying Manual.
After instructing the customer in the operation of the equipment, have him fill out and sign the warranty. Then fill in your own section of the warranty and give the customer his copy. Do not fail to send the manufacturer's copy to J. MORITA MFG. CORP.

PREVENT ACCIDENTS

Most operation and maintenance problems result from insufficient attention being paid to basic safety precautions and not being able to foresee the possibilities of accidents. Problems and accidents are best avoided by foreseeing the possibility of danger and operating the unit in accordance with the manufacturer's recommendations. First thoroughly read all precautions and instructions pertaining to safety and accident prevention; then, operate the equipment with the utmost caution to prevent either damaging the equipment itself or causing bodily injury.

Note the meaning of the following symbols and expressions:

WARNING

This warns the user of danger of death, serious bodily injury or total equipment damage and failure or fire.
This also provide information or procedure to reduce the danger.
If the symbol () is used, it means mandatory actions that you must take to enforce this procedure.

PROHIBITION

This identifies methods which must not be used or purposes which the instrument is not suited for.

CAUTION

This alerts the user to the risk of light to medium injury or equipment damage.

Usage Note

This alerts the user of important points concerning operation.

The user (e.g., healthcare facility, clinic, hospital etc.) is responsible for the management, maintenance, and use of medical devices.

This equipment must only be used by dentists and other legally licensed professionals.

**Do not use this equipment for anything other than its specified dental purpose.
This equipment is a general dental unit using for intra-oral dentistry.**

Federal law restricts this device to sale by or on the order of a dentist. (Valid only for U.S.A.)

Disclaimer

- J. MORITA MFG. CORP. will not be responsible for accidents, instrument damage, or bodily injury resulting from:
 - (1) Repairs made by personnel not authorized by J. MORITA MFG. CORP.
 - (2) Any changes, modifications, or alterations of its products.
 - (3) The use of products or instrument made by other manufacturers, except for those procured by J. MORITA MFG. CORP.
 - (4) Maintenance or repairs using parts or components other than those specified by J. MORITA MFG. CORP. and other than in their original condition.
 - (5) Operating the instrument in ways other than the operating procedures described in this manual or resulting from the safety precautions and warnings in this manual not being observed.
 - (6) Workplace conditions and environment or installation conditions which do not conform to those stated in this manual such as improper electrical power supply.
 - (7) Fires, earthquakes, floods, lightning, natural disasters, or acts of God.
- The useful life of the SPACELINE EMICA is 10 years (based on self-certification) from the date of installation provided it is regularly and properly inspected and maintained.
- J. MORITA MFG. CORP. will supply replacement parts and be able to repair the product for a period of 10 years after the manufacture of the product has been discontinued.

- * Instruments such as the air turbine handpieces, the micromotor handpiece, and the Luna Vue Light have separate user manuals. Do not fail to read these manuals before using the instruments.
- * Connect only handpieces and syringes specified by J. MORITA OFFICE to the main tubes; never connect instruments not specified and authorized by J. MORITA OFFICE. Unauthorized instruments could come off during use and cause an injury. J. MORITA OFFICE will not be responsible for malfunctions, damage or injuries resulting from use of unauthorized instruments.

Warnings and Prohibitions

WARNING

- *Do not use the unit where the floor might be wet.*
- *Do not modify this equipment without authorization of the manufacturer.*
- *Always turn off the main switch before doing maintenance. Otherwise, there is a risk of electric shock and burns.*
- *To avoid the risk of electric shock, this equipment must only be connected to supply mains with protective earth.*

PROHIBITION

- *Electromagnetic waves from cell phones, transceivers, and remote control devices could cause this instrument to operate erratically. Turn off all communication devices of this type in the operating area.*
- *Never use ultra sonic scalers for patients who have a pacemaker or an implantable cardioverter defibrillator (ICD); these instruments could cause the pacemaker or the ICD to operate erratically.*
- *Electrical noise generated by instruments like electric scalpels could cause this equipment to operate in an erratic and dangerous manner. Turn the unit completely off before using instruments that generate relatively high levels of electrical noise.*

Safety and Accident Prevention for the Operation of Electrical Medical Devices

1. Only fully trained and qualified personnel may operate equipment.
2. Items to be duly noted when installing equipment.
 - 1) Locate the unit in a place where it will not get wet.
 - 2) Install the unit in a location where it will not be damaged by air pressure, temperature, humidity, direct sunlight, dust, salts, or sulfur compounds.
 - 3) The unit should not be subjected to tilting, excessive vibrations, or shocks (including during shipping and handling).
 - 4) Do not install the unit where chemicals are stored or where gas may be released.
 - 5) Follow all electrical specifications including frequency (Hz), voltage (V), and current capacity (A) (power consumption)
 - 6) The equipment must be properly grounded.
3. Item to be duly noted before use.
 - 1) Inspect all switch connections, polarity, dial settings, meters etc. to confirm that the equipment will operate properly.
 - 2) Confirm that the ground is connected properly.
 - 3) Confirm that all cords are connected properly.
 - 4) Take into consideration that simultaneous use of more than one instrument or device can create a dangerous situation or lead to a mistake in diagnosis.
4. Item to be duly noted during use.
 - 1) Never use the equipment for treatment or diagnosis more than necessary or for longer than necessary.
 - 2) Maintain a constant vigilance for abnormal conditions in both the equipment and the patient.
 - 3) Appropriate steps, such as shutting the equipment down, should be devised to protect the safety of the patient in case any abnormalities in the equipment or the patient are observed.
 - 4) Make sure the patient does not handle or manipulate the equipment.
5. Item to be duly noted after use.
 - 1) Turn the power off after returning dials, switches etc. back to their original positions in the prescribed order.
 - 2) Do not use excessive force or pull the cord itself to disconnect cords.
 - 3) The following items should be considered when storing the equipment:
 1. The storage area should protect the equipment from getting wet.
 2. The storage area should protect the equipment from any possible damage due to atmospheric pressure, temperature, humidity, wind, direct sunlight, dust or air containing salts or sulfur.
 3. The equipment should be protected from tilting, vibrations, percussive shocks, etc. (including when it is being moved).
 4. The storage area should be free of chemicals and gases.
 - 4) All accessories, cords, guides etc. should be cleaned, properly arranged and carefully put away.
 - 5) Before storage, the equipment should be cleaned so that it is ready to be used again.
6. In case of a malfunction or defect, the operator should attach a written notice indicating that the equipment is out of order without attempting to repair the equipment himself; repairs should be referred to a qualified serviceman.
7. Equipment should not be modified in any way.
8. Maintenance and Inspection
 - 1) All equipment and components should be inspected regularly.
 - 2) Equipment which has not been used recently should always be inspected to confirm that it functions properly and safely before being put back into use.



Parts Identification and Accessories

1. Parts Identification and Warning Labels

* Do not fail to read all the warning labels.

TYPE PdW

 WARNING	<ul style="list-style-type: none"> ● Turn off the unit as well as the main power supply circuit breaker before replacing fuses. Failure to do so may result in electric shock.
---	---

	 Hands Together	 Feet Together
Have the patient sit as shown in the illustrations above		
NOTE <ul style="list-style-type: none"> • Before moving the chair, make sure patients' hands and feet are together and centered. • During treatment, make sure the cover for the Water Flushing System is closed tightly. 		

 WARNING	<ul style="list-style-type: none"> ● Make sure the area is clear of obstructions and that no one has their fingers in the gap between the backrest and the seat prior to moving the chair. Failure to do so may result in injury.
---	--

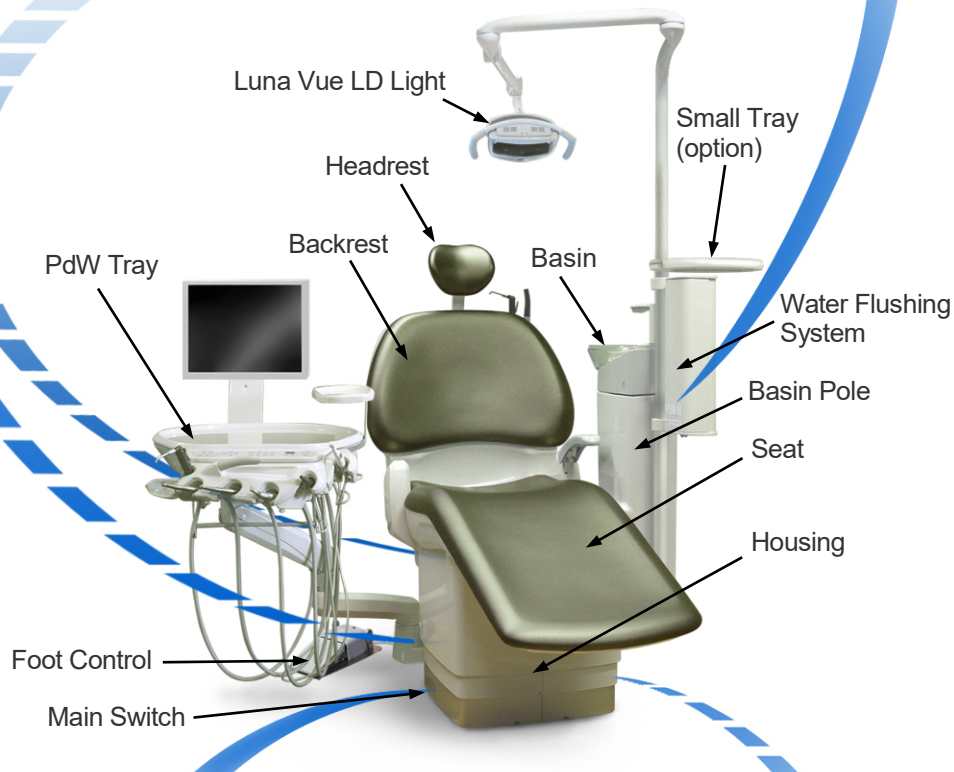

 WARNING	<ul style="list-style-type: none"> ● Turn off main switch after each use to avoid possibility of water leakage or fires due to overheating.
	<ul style="list-style-type: none"> ● Turn off main switch before performing regular maintenance procedures to avoid risk of burns or electric shock.

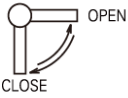
 WARNING	<ul style="list-style-type: none"> ● Shut off main water valve after each use to avoid possibility of water leakage. 	
---	---	---

TYPE PdW (FT)

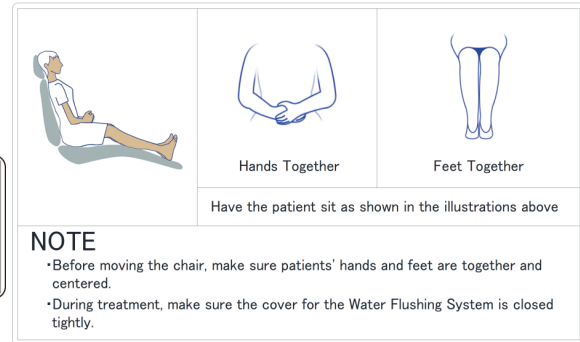

 WARNING	<ul style="list-style-type: none"> • Turn off the unit as well as the main power supply circuit breaker before replacing fuses. Failure to do so may result in electric shock.
--------------------	---

 WARNING	<ul style="list-style-type: none"> • Make sure the area is clear of obstructions and that no one has their fingers in the gap between the backrest and the seat prior to moving the chair. Failure to do so may result in injury.
--------------------	--

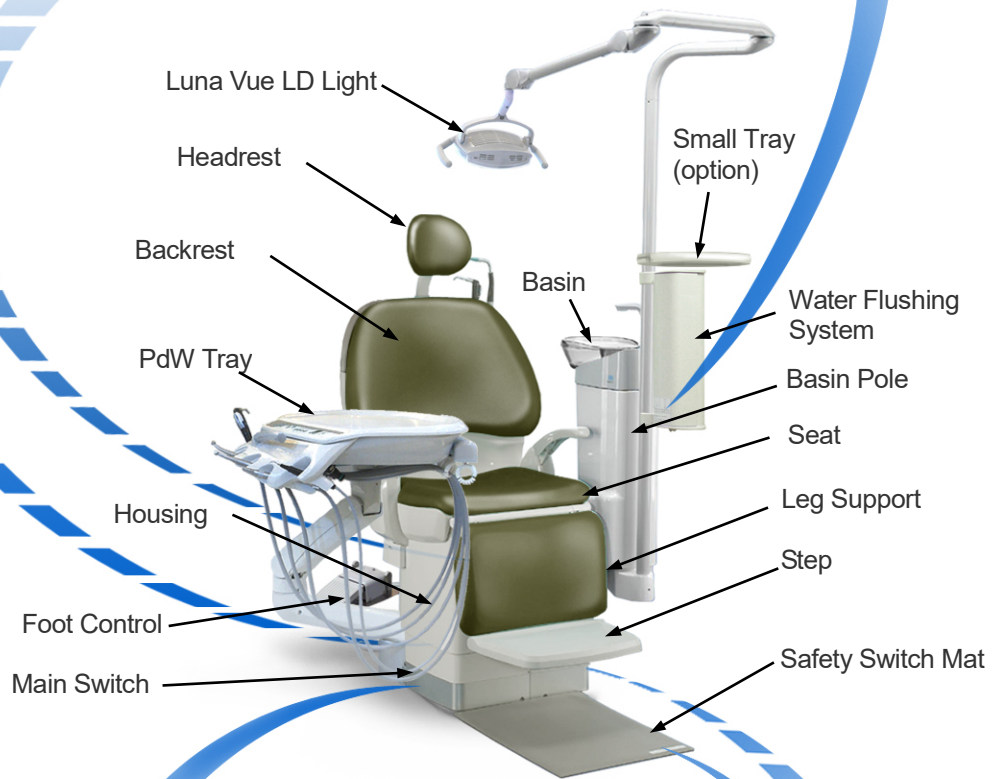

 WARNING	<ul style="list-style-type: none"> • Turn off main switch after each use to avoid possibility of water leakage or fires due to overheating. • Turn off main switch before performing regular maintenance procedures to avoid risk of burns or electric shock.
--------------------	---

 WARNING	<ul style="list-style-type: none"> • Make sure the area is clear of obstructions and that no one has their fingers in the gap between the leg support and the seat or housing prior to moving the chair. Failure to do so may result in injury.
--------------------	--

 WARNING	<ul style="list-style-type: none"> • Shut off main water valve after each use to avoid possibility of water leakage. 	 OPEN CLOSE
--------------------	---	-------------------

Shoulder

Note on Glass Basin and Cup Stand

- Do not bump or apply excessive loads to these glass products.
- Always turn the main switch off before disassembly.
- Do not drop.
- To assemble, make sure components are fit all the way into place.
- Do not turn on main switch until assembly is completed.

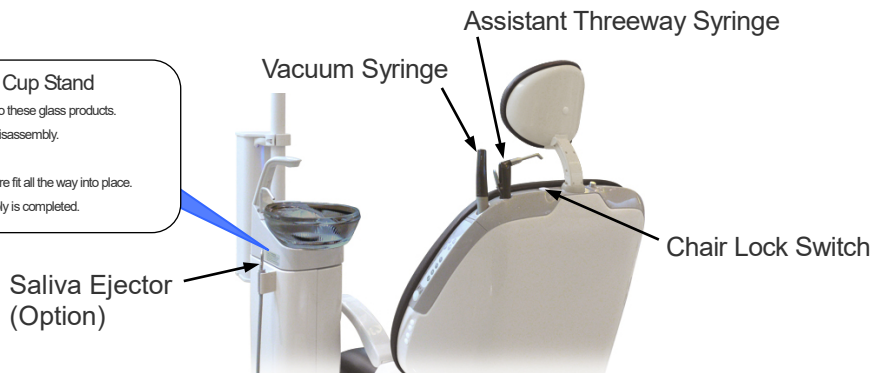

PdW Tray

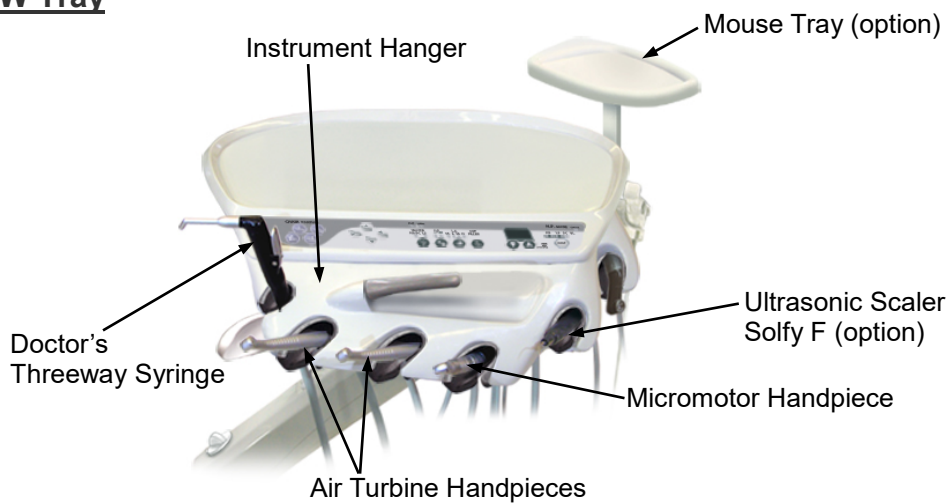

*** Complete option configuration**

Foot Control

Low Two-pedal Model

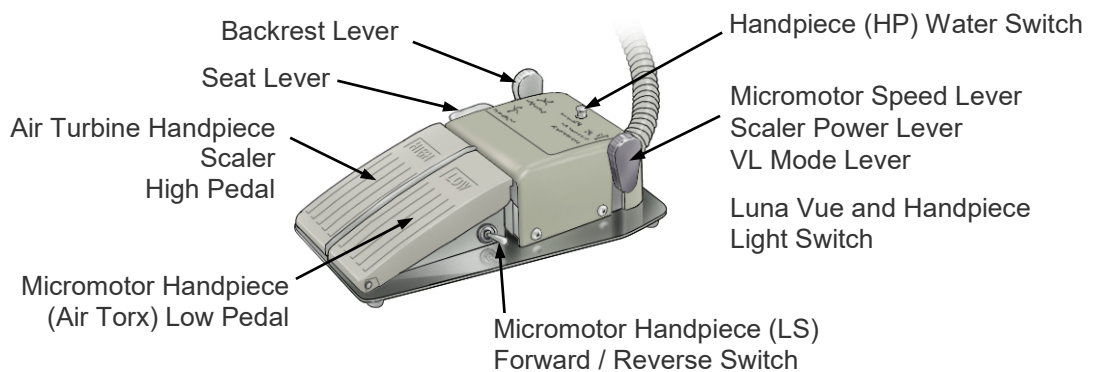

Low Single Pedal Model (option)

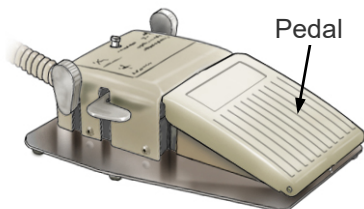

* Step on the pedal to operate the selected handpiece and release the pedal to stop it.

Water Flushing System



This system cleans up the waterlines of the chair-unit. After treatment, leave the diluted solution of cleanser in the waterlines. Before the next treatment, flush out the cleanser in the waterlines with regular tap water.

ⓘ **WARNING**

- Use only cleansers recommended by J. Morita to clean up the waterlines.
- Follow the recommended dilution rate (x30) to clean up the waterlines.
- Connect the blue water tube to the "tap water" connector on flushing system control panel before beginning treatment.
- Make sure the cleanser flushing have been finished out (Flush Lamp is on constantly) before beginning treatment.

⚠ **CAUTION**

- Make sure the pressure gauge reads 0.18 to 0.20 MPa before cleaning up the waterlines.
- Check the following things if the waterlines clean-up have stopped.
 - Turn water valve off and then pull out threeway syringe. Hold the end of the syringe over the basin or some other container. Hold the water lever down until water stops coming out.
 - Check the following things if no water flows into the flushing bench or the cleaning solution in the bottle does not go down.
 - ① Make sure the white air tube is properly connected.
 - ② Make sure the blue cleaning solution tube is properly connected.
 - ③ Make sure the pressure gauge reads 0.18 to 0.20 MPa.
 - ④ Make sure the air and cleaning solution tubes are not pinched.
- In the case that this system do not run in spite of operating according to "Water Tube (blue) Connection", follow the operation manual from the first process.
- During treatment, close the cover of this system.

Inside Maintenance Cover

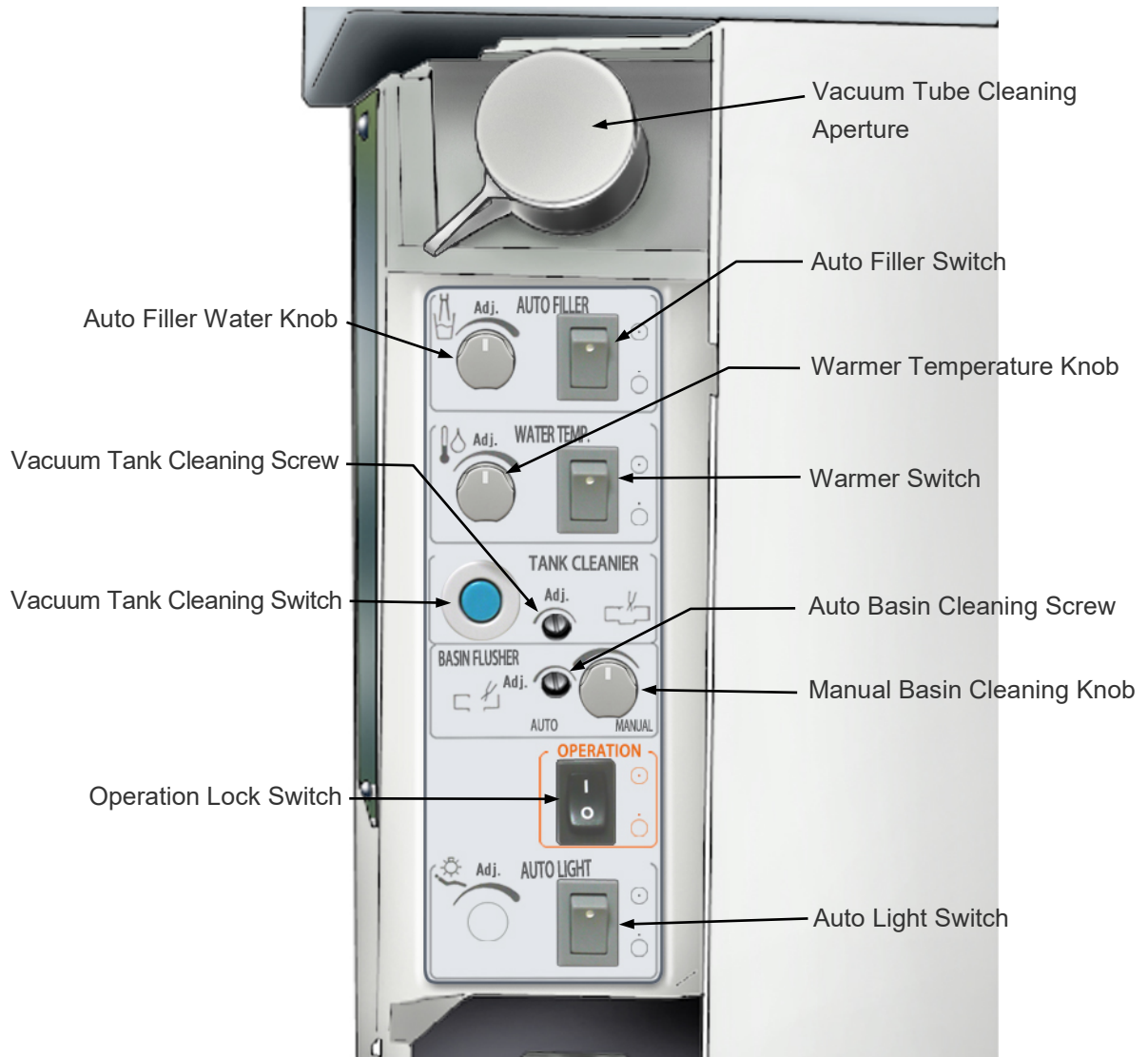

*** Model equipped with all options**

Tray and Shoulder Switches

PdW Tray

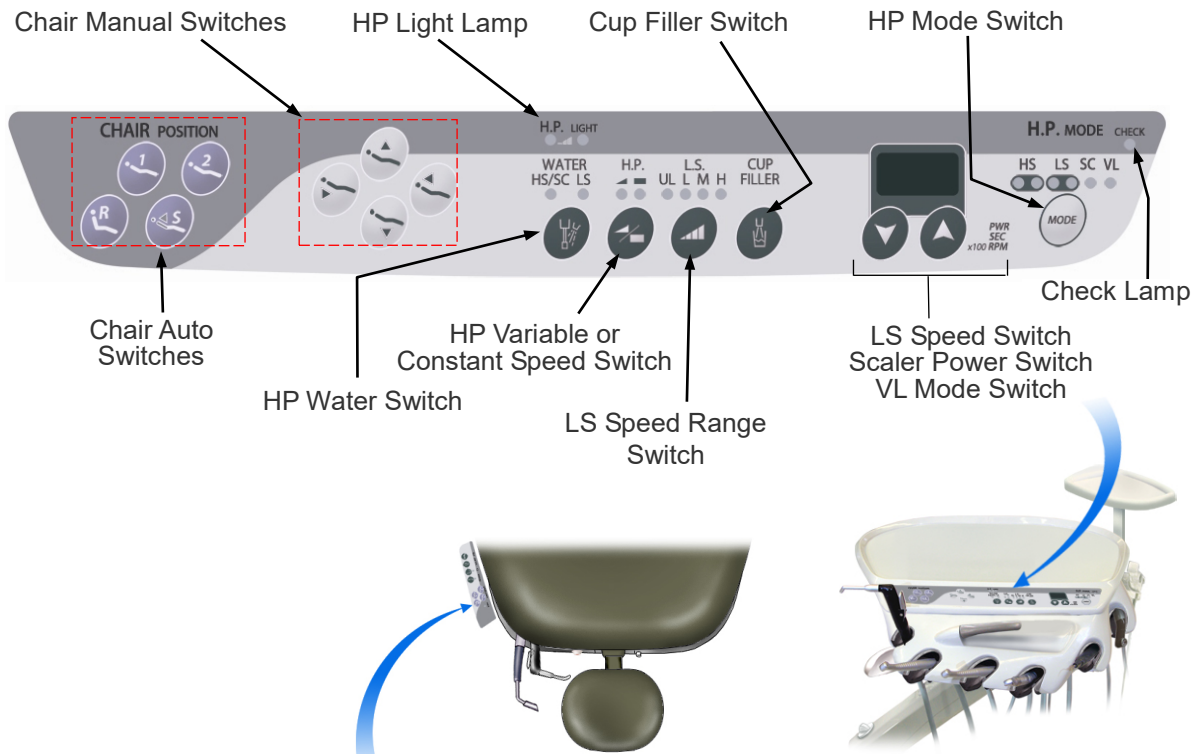

Shoulder, Assistant's Side

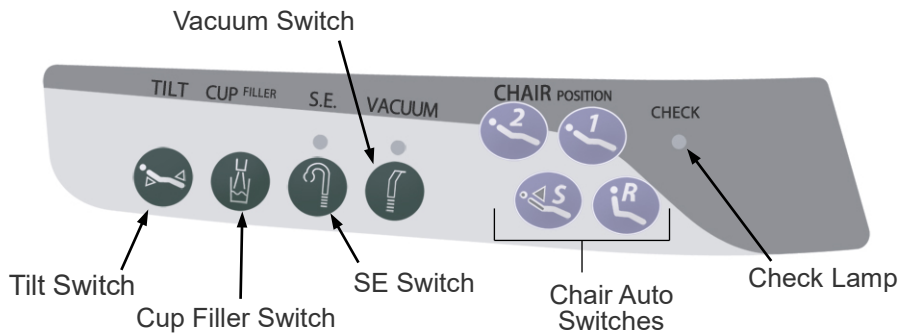

Abbreviations

- HP: Handpiece
- HS: Air Turbine
- LS: Micromotor
- SC: Scaler
- VL: Visible Light Cure
- SE: Saliva Ejector

Switches on Assistant Instrument Holder (Option)

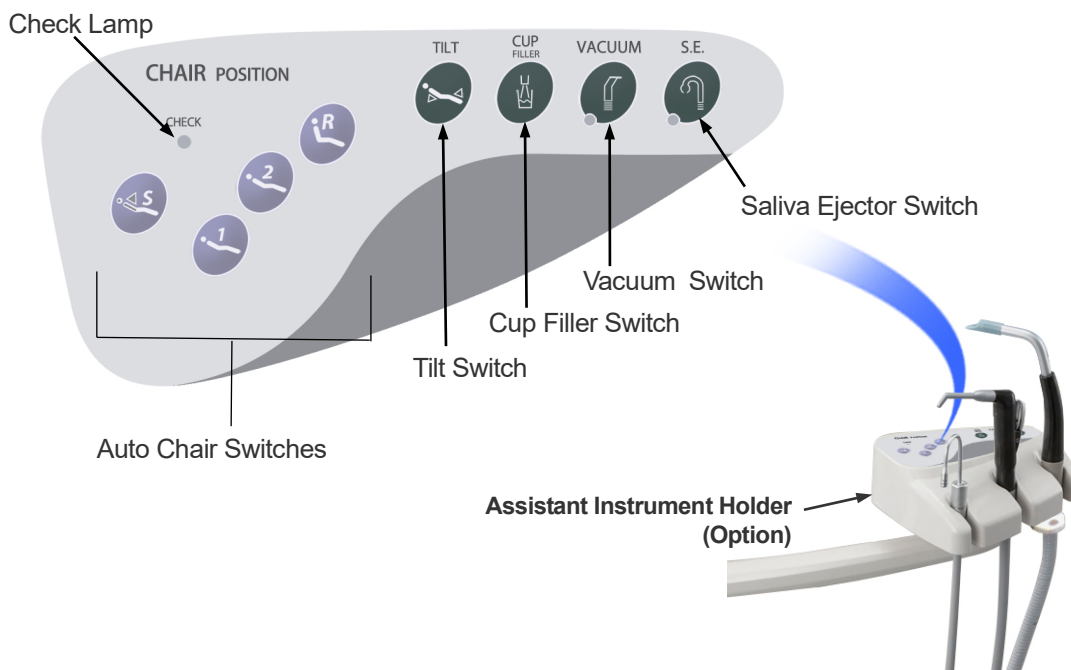

⚠ CAUTION

- *Make sure that patients, especially children, do not touch any of the switches. Also make sure that pendants, bracelets or similar things worn by patients, assistants and doctors do not touch any of the switches. Unintentional activation of the chair etc. could result in an accident.*

Usage Note

- ◆ *Only use your finger to press the shoulder switches; hard instruments can break the switches.*

2. Accessories

- Headrest Cover (1)
- Vacuum Tips for Vacuum Syringe (5)
- Rubber Tips for Vacuum Syringe (5)
- Tray Sheet (1)
- Waste Cup Holder (1)
- Medicinal Vial Holders (2)
- Paper Cups (3)
- Tops for Paper Cups (3)
- Cap for Threeway Syringe with Light (Option) (1)
- Saliva Ejector Tip (Option) (1)
- Protective Sheets (samples) (3)

* Accessories depend somewhat on the exact configuration of the model.

Operation

- * **Operation Conditions:**
 - Temperature: +10°C to +35°C (+50°F to +95°F)
 - Humidity: 30% to 75% (without condensation)
 - Atmospheric Pressure: 70 kPa to 106 kPa.
- * Have patients remove necklaces, glasses and other things that could hinder treatment.
- * Inspect the unit before using it to make sure it operates properly and safely. Flush the cleanser out of the water lines.

WARNING

- *In case of lightning, avoid the risk of electrical shock: Stop using the equipment immediately and have the patient move away from it. Do not touch the equipment or the main power cord.*

1. Preliminaries

(1) Turn Main Switch On

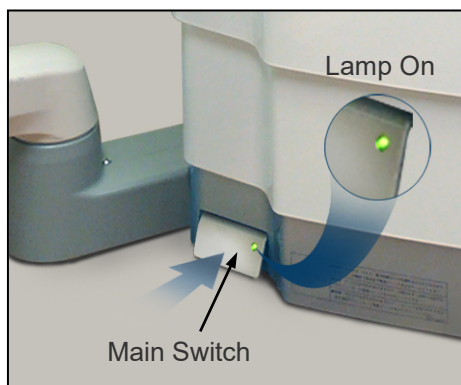

Press the main switch to turn the unit on.
The lamp lights up to show the power is on.

- * If the chair is not used for 2 hours, the unit will turn off automatically. (The lamp for the main switch and the Check lamps on the tray and the assistant instrument holder will start blinking on and off.) Turn the unit back on by pressing the main switch twice.

(2) Main Water and Air Valves

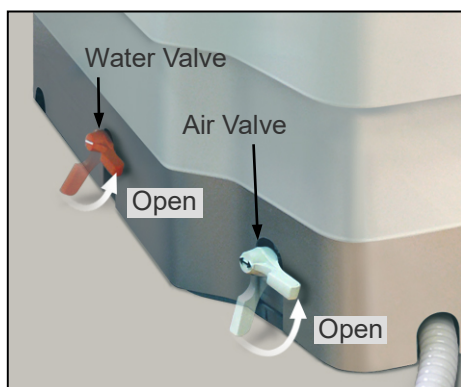

Open Water and Air Valves

Swing the levers up to open the valves.

CAUTION

- *Internal water pressure is set at 0.2 MPa. If the pressure goes over 0.39 Mpa, a release valve opens and water will start coming out of the basin water spout. If this happens, there could be a problem with the water regulator valve or some other malfunction. In this case, contact your local dealer or J. MORITA OFFICE.*
- *If air leaks or does not come out, there could be a problem with the air regulator or main valve. In this case, contact your local dealer or J. MORITA OFFICE.*

(3) Flush Out Cleanser



1. Make sure the bottle switch is turned off.
2. Disconnect the blue water tube from the bottle and reconnect it to the water connector on the operation panel for the flushing system.
3. Open the water valve.
4. Press the Water Flush switch. This will flush out the water lines inside the chair.
5. For details on how to use the Water Flushing System, see page 68.

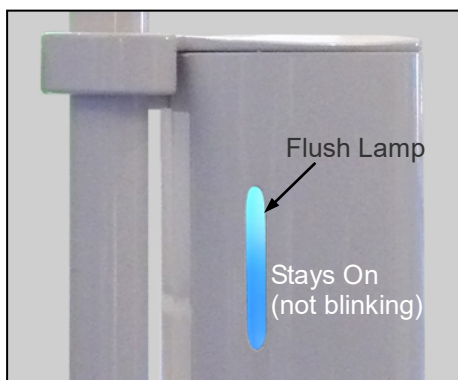

⚠ WARNING

Never use the unit if cleanser is still in the water lines.

- **Check the following three things before beginning treatment:**
 - ① **Make sure the blue water tube for the flushing system is connected to the water connector on flushing system control panel.**
 - ② **Make sure the water lines have been flushed out with regular tap water.**
 - ③ **Make sure the Flush Lamp stays on constantly and is not blinking.**

(4) Inspect Before Use



1. Chair Operation

See instructions on page 16 and make sure the chair operates properly.

2. Air Turbine Handpiece Operation

See instructions on page 33 and make sure the air turbine handpieces operate properly.

3. Micromotor Handpiece Operation (TORX [TR-S2 series] or Air Torx)

See instructions on page 37 and make sure the micromotor handpiece operates properly.

4. Threeway Syringe Operation

See instructions on page 43 and make sure the threeway syringes operate properly.

5. Vacuum Syringe

See instructions on page 48 and make sure the vacuum syringe operates properly.

2. Operation Instructions

(1) Chair Operation

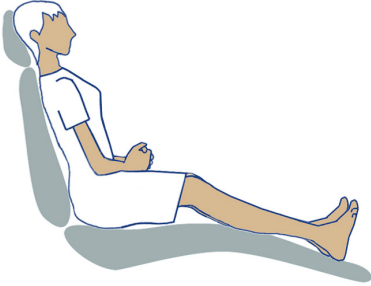

Hands Together

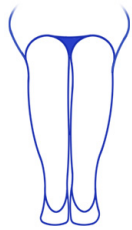

Feet Together

Sitting Position

Have the patient sit all the way back in the chair as shown in the illustration.

Before Moving the Chair

Before moving the chair, have the patient fold his hands on his stomach and put his feet together in the center. Warn the patient before moving the chair.

While chair is moving

Make sure the patient keeps his hands and feet still while the chair is moving.

Children

Before raising the backrest, slide children down so that their buttocks are on the seat. Make sure their hands and feet are in the proper position and then raise the backrest.

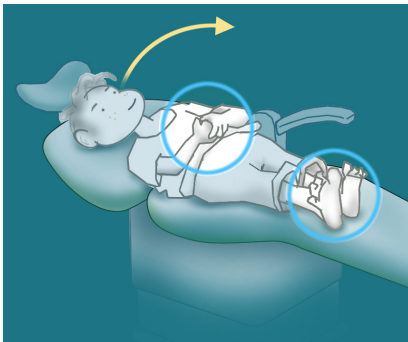
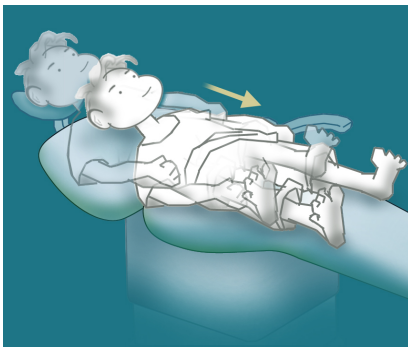

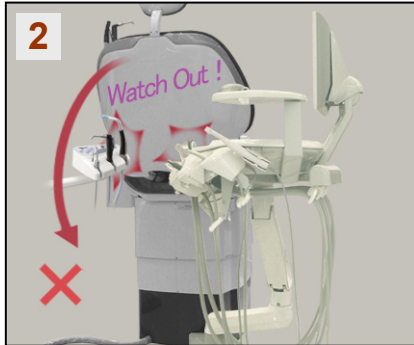
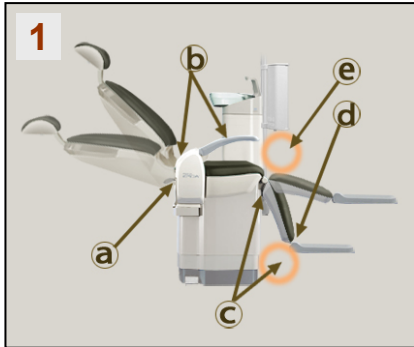

Avoid accidents!!

Read the following warnings carefully.

⚠️ WARNING

- **The chair is for a single occupant only.**
 - **Do not let patients hold their children.**
- **Have patients get in and out from the side, not from the front of the chair.**
- **Have the patient seated or lying face up.**
 - **Do not let patients stand on the chair, lie face down or sit on their legs.**
 - **Do not let patients sit on the edge of the chair.**
- **Before moving the chair, warn the patient and check the following:**
 - **Patient is properly seated with no body parts sticking out**
 - **Patient is not resting his hand on the arm rest.**
 - **No one, especially a child, is under the backrest or seat, and that the area is clear and free of obstacles.**
 - **For the FT type, no one is under the step and it is clear and free of obstacles.**
 - **Especially watch out for children.**
 - **Make sure no one has his fingers or other body parts in the gaps indicated by “a”, “b”, “c”, “d” and “e” in the illustration.**
 - **The cover for the Water Flushing System is properly closed.**
 - **The patient is not firmly gripping the arm rest or other part of the chair.**
 - **The patient, backrest or seat does not hit the tray or the assistant instrument holder when raising or lowering the backrest and the seat. (Photos 2, 3, and 4.)**
 - **Make sure the patient is not gripping the basin when the backrest is raised; the patient’s arm could be pinched between the chair and the pole and injured.**
 - **For the FT type, the patient has his feet properly positioned on the step. Otherwise, his foot could be pinched by the light pole. (Photo 5.)**
- **Do not use this chair for patients who weigh more than 135 kg (297 lb).**

Foot Control Levers and Tray Switches for Chair Operation

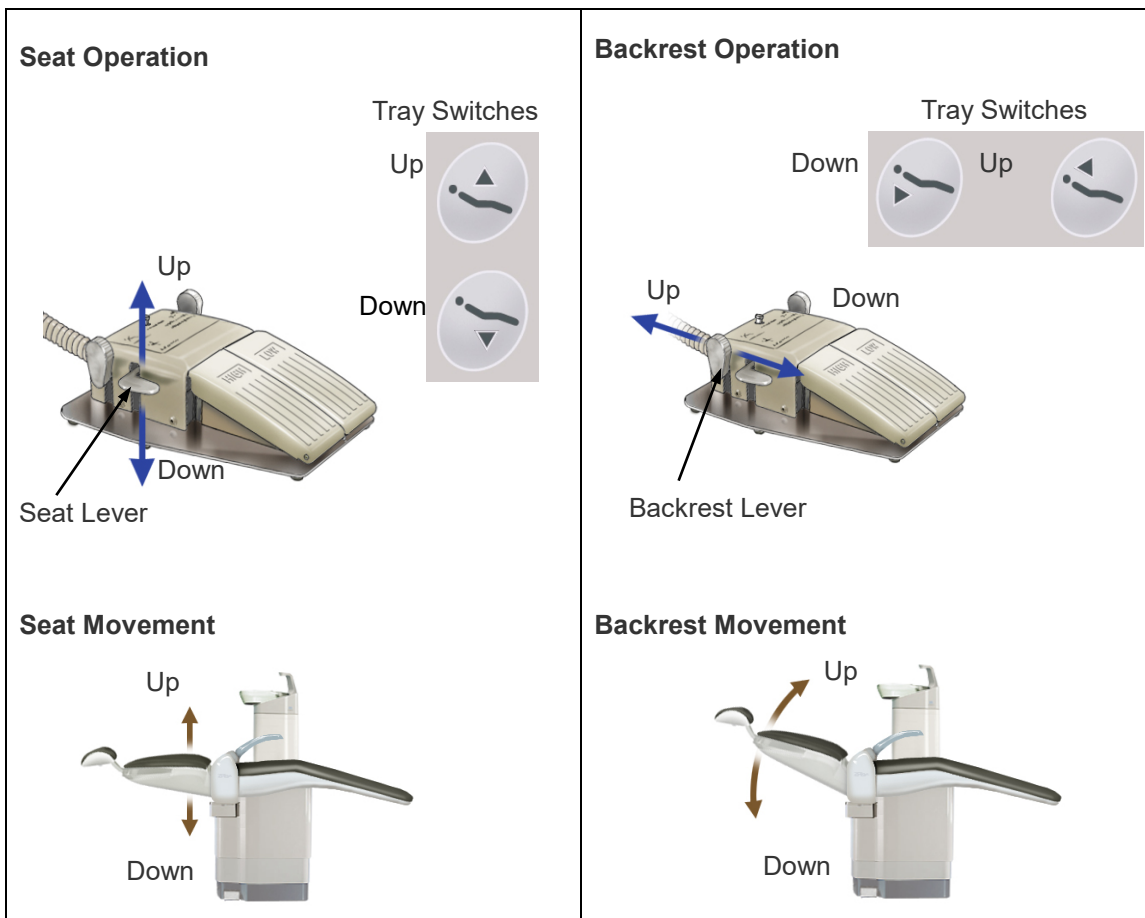

- * The chair only moves while you are operating one of the levers.
- * The chair will not move when an air turbine, micromotor or scaler handpiece is in use even if one of the levers or switches is pressed accidentally.

CAUTION

- *Take care that the casters on the operating stool do not touch the elevation or tilt lever on the foot control; this could cause the chair to move and cause an accident.*

Safety Switches

Usage Note

- ◆ *If the Check Lamp on the assistant side is blinking on and off, one of the safety switches has been activated. Check the places indicated by the arrows in the photos on this page and remove any objects that are blocking the chair's movement.*

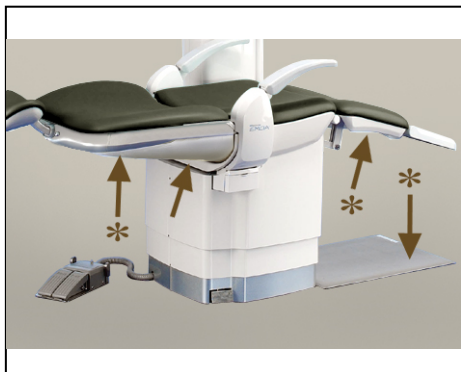
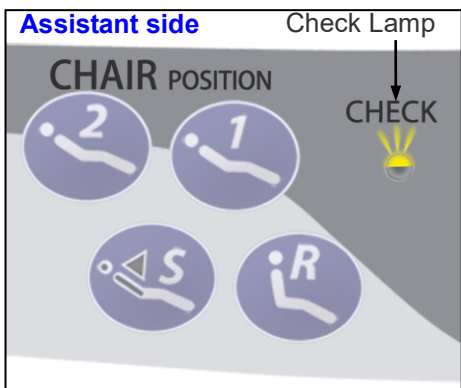
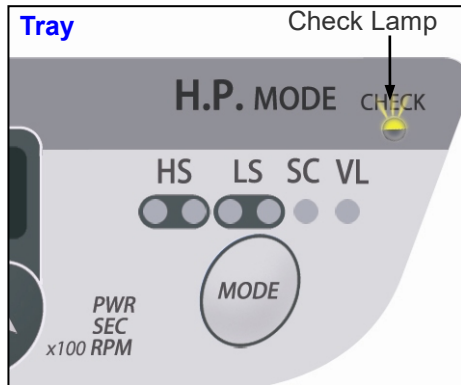





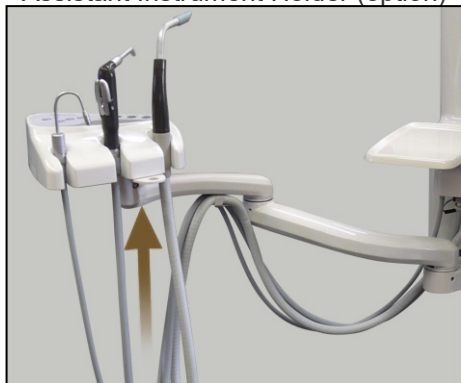

- * FT only

Assistant Instrument Holder (option)



Chair Auto Positioning

 <p>Use the auto positioning switches on the tray or the assistant's side.</p>			
	Position 1	Position 2	R (Patient In or Out)
			
S (mouth rinsing)			
<p>Up</p> 	<p>1. Press Switch S to raise the backrest and allow the patient to rinse his mouth.</p>	<p>Down</p> 	<p>2. Press Switch S to lower the backrest back to the treatment position.</p>

WARNING

- ***When using the auto switches, make sure the patient is in the proper position as instructed and do not leave the chair.***

- * The chair can be stopped immediately in case of an emergency in the following ways:
 - Press the elevation lever, tilt lever, high pedal or low pedal on the foot control. Press any auto or manual chair positioning switch.
 - Press but do not hold down a lever, pedal or switch. Holding them down will activate the function of the lever or pedal.
 - Also be careful with the auto switches; the chair will stop if an auto switch is pressed once but it will start to move if it is pressed again.
- * The chair will not move when an air turbine, micromotor, or scaler handpiece is in operation even if one of the auto-positioning switches is accidentally pressed.
- * When the R switch is pressed, the vacuum tank will be automatically cleaned after the chair moves.

FT Tilt Switch

Press the Tilt Switch

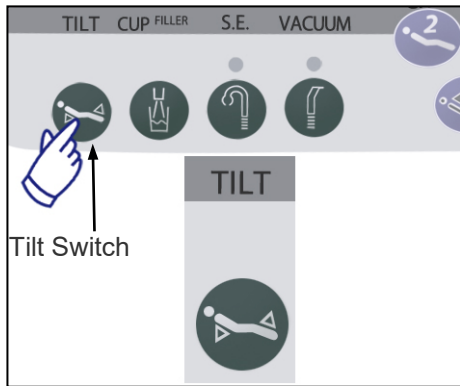

The backrest tilts down -5°.

- * For units other than the FT type, nothing happens when the Tilt Switch is pressed.

Chair Lock Switch

Press the Chair Lock Switch to prevent the chair from moving during treatment.
(The white lamp will light up.)

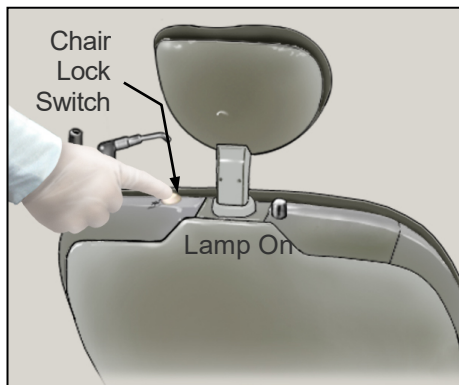

- * In this case, the chair will not move even if the auto or manual switches are pressed or if the levers on the foot control are pressed.
To move the chair, press the Chair Lock Switch again to release the lock. (The lamp will go out.)

Operation Lock Switch

Turn the main power on and open the maintenance door. Press the Operation Lock Switch to disable all operations and instruments except the Luna Vue Light and the vacuum syringe. All other functions will be disabled.

The Check Lamp on the shoulder on the assistant side will start blinking.

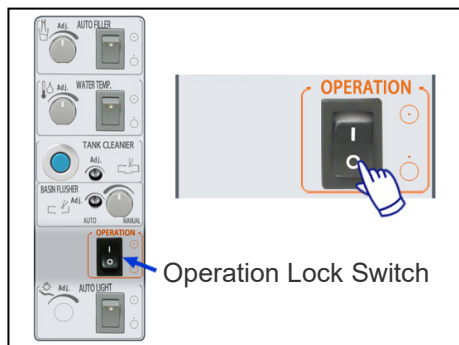

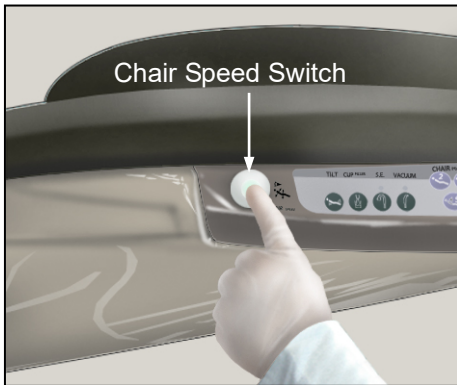

Chair Speed Switch

Press the Chair Speed Switch to slow down the chair's movement (both seat and backrest).
(The green lamp will light up.)

Press the same switch again to return to normal speed; the lamp will go out.

- * This is useful when making minor adjustments to use a microscope; it is also good for elderly patients.
- * Contact J. MORITA OFFICE if you wish the chair to move even more slowly.

⚠ CAUTION

- *When using a microscope, check the chair speed and make sure that the green lamp is on.*

Usage Note

- ◆ *When using a microscope, keep in mind that the speed at which the chair goes up depends somewhat on the patient's weight.*

Memorizing Auto Chair Positions

Four positions can be memorized (1, 2, R and S). (Backrest angle and seat height)

Tray

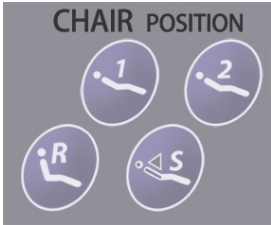

Assistant Side
Shoulder Instrument Holder

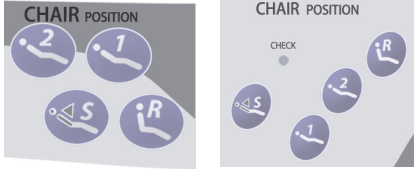

Step 1
Put the chair in the desired position with the seat and backrest levers on the foot control or the manual switches on the tray.

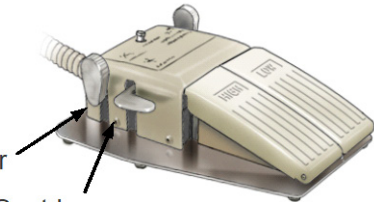



Backrest Lever
Seat Lever

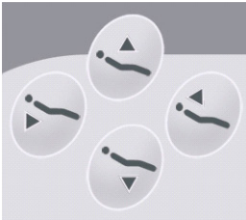

Foot Control



Tray

Step 2
Position to be memorized





The R position is set for when the patient gets in and out of the chair.



The S position is for mouth rinsing. Only the backrest moves.



Hold switch down for about 5 seconds until beep sounds.

Usage Note

- ◆ *The position will not be memorized if the switch is released before the beep sounds.*
- * The same procedure is used if you wish to change any of the positions.

(2) Headrest

There are four types of headrests: natural movement, ratchet, slide, and two-axle types. Refer to the type that your unit has.

WARNING

- *Suddenly lowering the headrest could injure the patient. Always support the head rest firmly and then carefully lower it. Watch out for slipping if the headrest has a cover.*
- *To adjust the angle of the headrest, make sure the patient's head is in the center of the headrest and that the headrest is firmly secured. If the patient's head is not properly centered, the headrest could stop in between angle settings. In this case, the patient might be injured if he moved his head and the headrest suddenly slipped out of place.*
- *Make sure the headrest is firmly secured after adjusting its angle. Otherwise the patient could be injured if it suddenly slipped out of place.*

1) Natural Movement

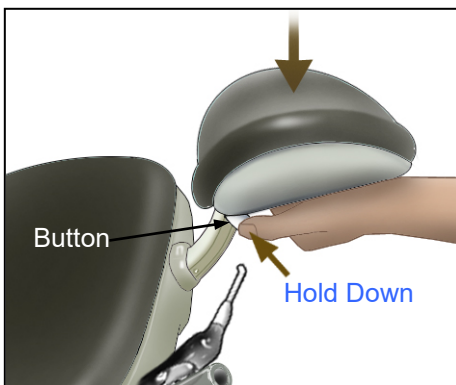

Lower

Support the headrest with your left hand, hold down the button and lower it. Then release the button.

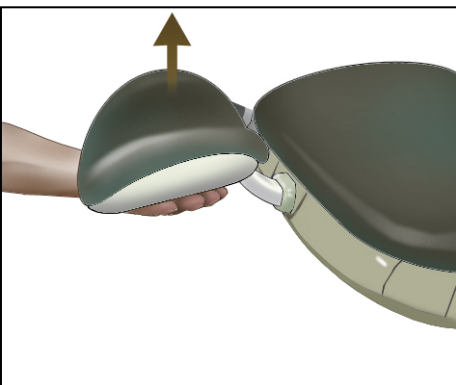

Raise

Simply raise the headrest up to the desired position.

2) Ratchet Type

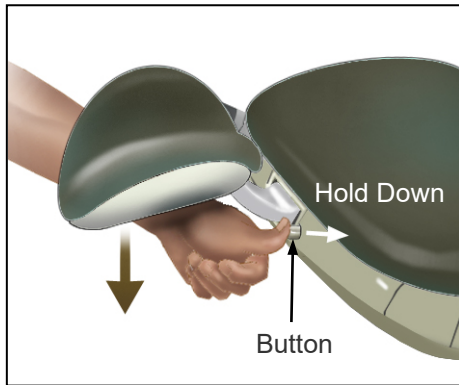

Lower

Support the headrest with your left forearm, hold down the button and lower it.

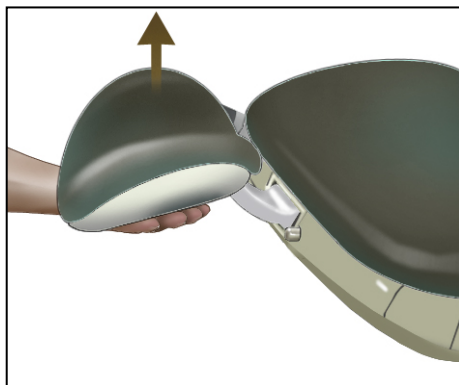

Raise

Simply raise the headrest up to the desired position.

3) Slide Type

WARNING

- *Support the head rest firmly to lower it when the backrest is raised. Otherwise, you might pinch your fingers or injure the patient.*
- *If the head rest is too high when the backrest is lowered, the patient's head could slip off, and he could be injured. Check the height carefully so that this will not happen.*

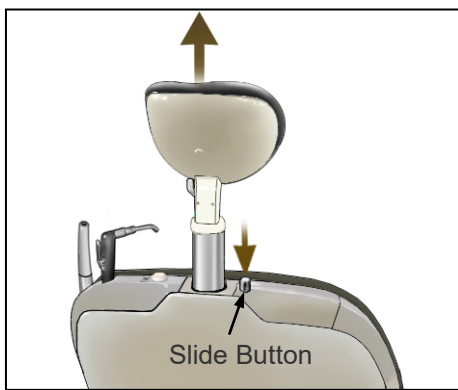

Slide Up

Have the patient take his head off the headrest, hold down the slide button and raise the headrest up to the desired position. Release the button, to lock the headrest in position.

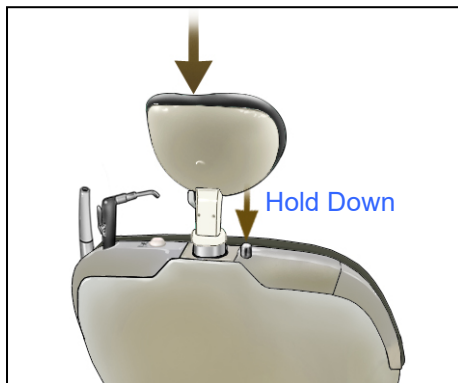

Slide Down

Have the patient take his head off the headrest, hold down the slide button and lower the headrest down to the desired position. Release the button, to lock the headrest in position.

- * The angle of the head rest is adjusted in the same way as the natural movement one above.

4) Two-axle Type

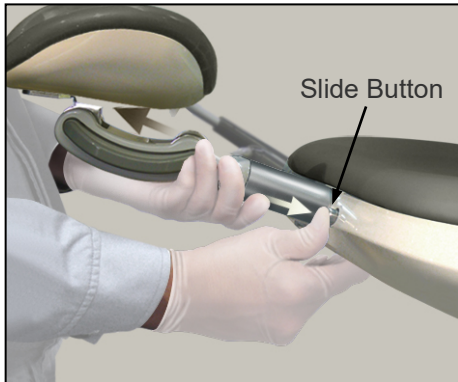

Slide Up

Have the patient take his head off the headrest, hold down the slide button and raise the headrest up to the desired position. Release the button, to lock the headrest in position.

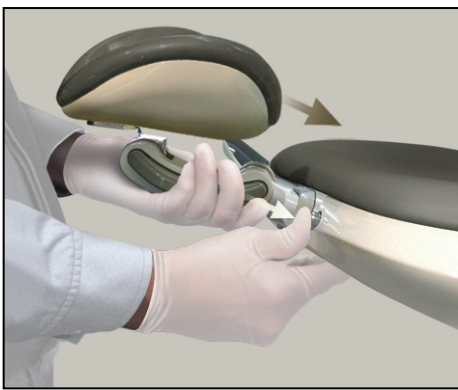

Slide Down

Have the patient take his head off the headrest, hold down the slide button and lower the headrest down to the desired position. Release the button, to lock the headrest in position.

WARNING

- *Be careful not to pinch your fingers when lowering the headrest.*

Headrest Angle

The angle of the two-axle sliding headrest can be set by rotating it at Point A or Point B.

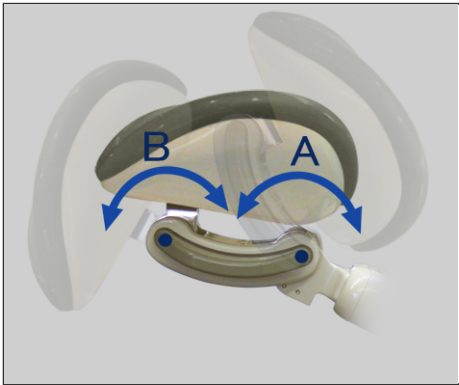

Support the headrest, press down on Point A on the release lever, and adjust the angle. Let go of the release lever to lock the headrest in place.

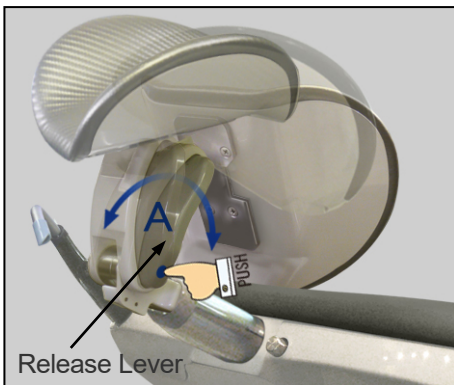

Support the headrest, press down on Point B on the release lever, and adjust the angle. Let go of the release lever to lock the headrest in place.

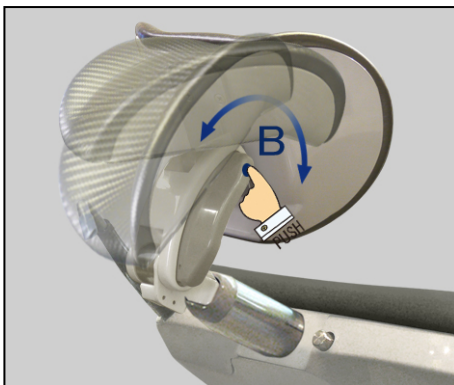

Support the headrest, press down on the center of the release lever, and adjust the angle. Let go of the release lever to lock the headrest in place.

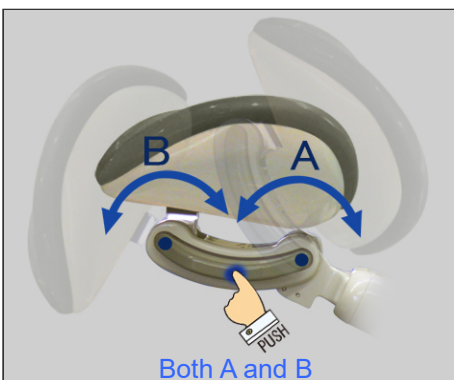

WARNING

- *Be careful not to pinch your fingers when lowering the headrest.*

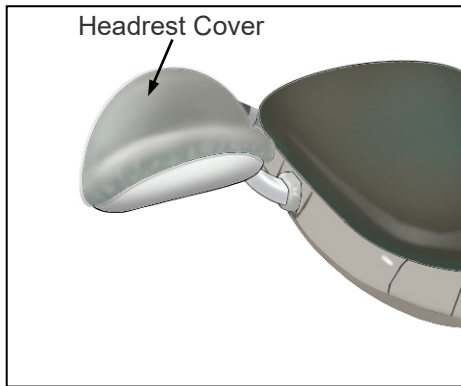

Headrest Cover

Use this to cover the headrest.

Usage Note

- ◆ *Exposure to direct sunlight could cause discoloration because of the ultra violet radiation.*

(3) FT Arm Rest, Doctor's Side



Pull the rotating part at the base of the arm rest and lift it up. Simply lower it to put it back in place.

⚠ CAUTION

- *Do not pinch the patient's fingers or hands or your own when moving the arm rest.*
- *When the arm rest is raised up, do not move the chair and do not grab the arm rest for support.*

(4) Instrument Tubes



Tray

Pull Out

The instrument that was first withdrawn has priority. Check the HP Selection Display to see which handpiece is ready to operate.

⚠ CAUTION

- *After attaching handpieces and syringes, give them a light pull and operate them away from the patient to make sure they are properly attached. Otherwise, air pressure could blow the instrument off its tube connection and cause an injury.*



Return

Return the instrument to its original holder.

⚠ WARNING

- *Make sure that handpieces are put all the way back in their holders. Otherwise, they could fall out or they may not be detected as being in their holders.*

Usage Note

- ◆ *Be especially careful when putting away handpieces which are equipped with a light. Bumping these instruments too hard could disconnect or break the lamp.*

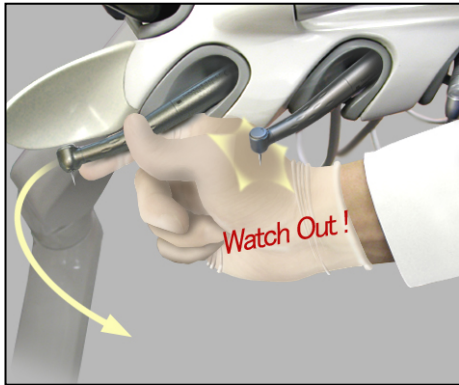

⚠ CAUTION

- *If a handpiece is not attached to a tube, it may not be detected by the sensor; always check the HP selection lamp before using a handpiece.*
- *Do not leave burrs, files or tips in handpieces when putting them away. They could injure fingers, hands etc., tear clothes or damage something.*
- *Never take out more than one handpiece at a time.*

Assistant Side

Pull Tube Out

Pull the tube out until it is held by its stopper.

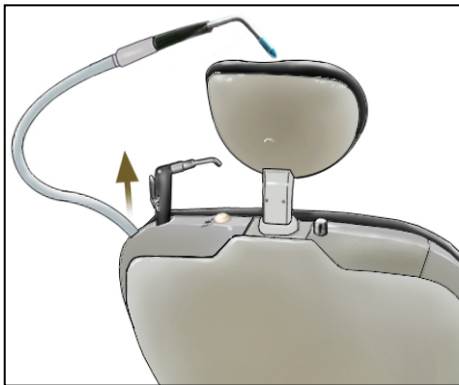

Put Tube Away

Give the tube a light tug to release the stopper and allow it to be drawn back into the chair.

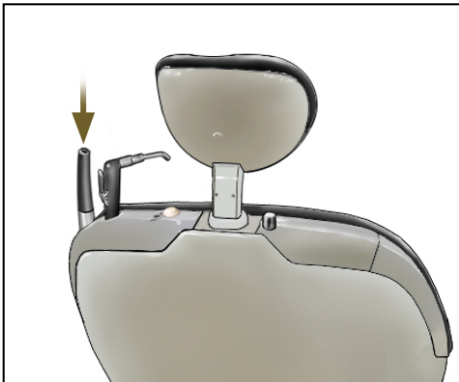

⚠ WARNING

- *Connect only instruments approved by J. MORITA OFFICE to the main tubes. Do not connect instruments not approved by J. MORITA OFFICE. Instruments that have not been approved for use by J. MORITA OFFICE could come off and cause an injury.*

(5) Switch Lamps and Displays

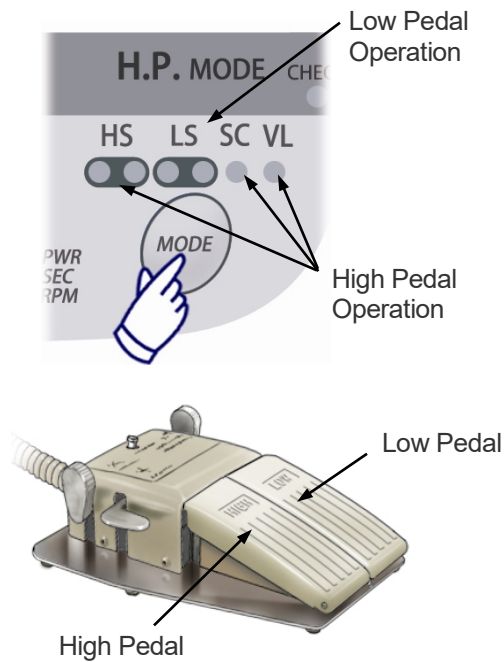
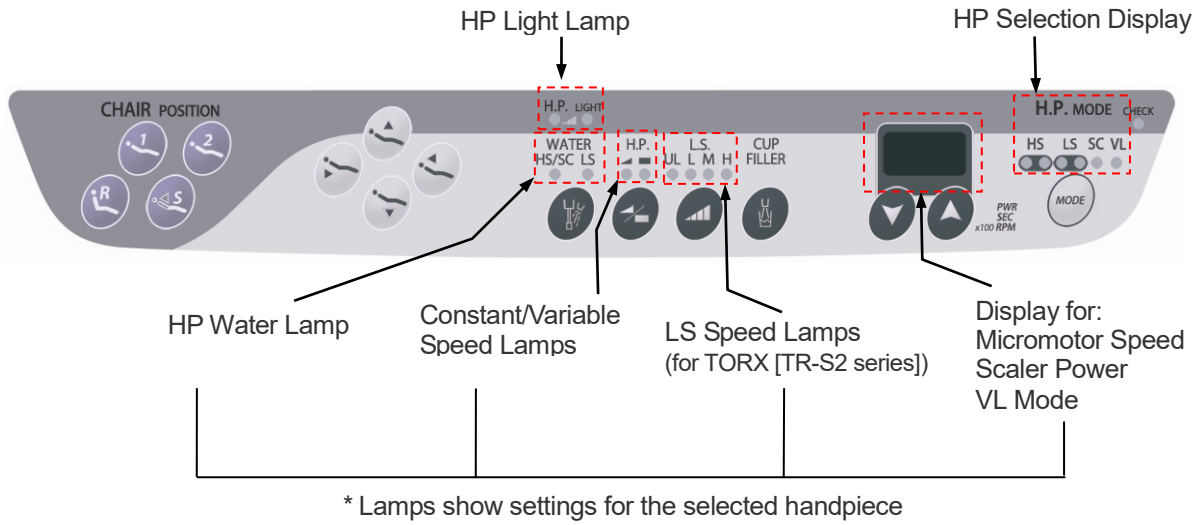

* Step on the pedal to operate the handpiece indicated by the lamp that is on.

⚠ WARNING

- **Check the lamp for the selected handpiece and its settings. Otherwise, inadvertent operation of a handpiece could result in an injury.**

◆ Do not pull the foot control with excessive force; this could break its cord.

(6) Air Turbine Handpiece

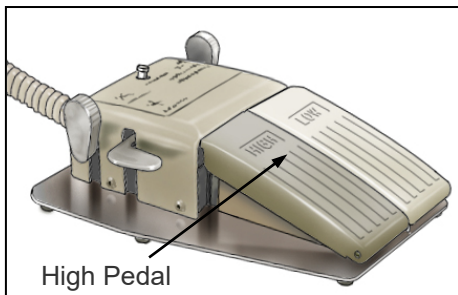
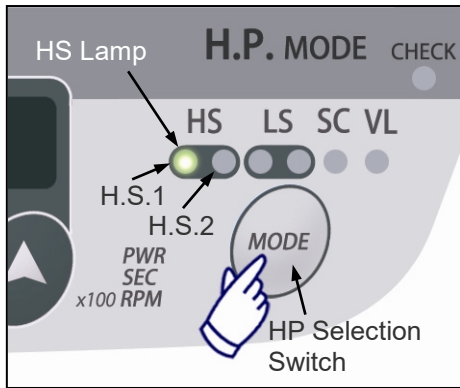

- * Also refer to the separate user manual for the Air Turbine Handpiece.

Handpiece Selection

Take the handpiece off its hanger and check that the HS lamp lights up.

- * The first handpiece taken off its hanger has priority so put any other handpiece back on its hanger. (You may also use the HP Select switch to select the handpiece.)

Handpiece Operation

Step on the High pedal to start the handpiece. Release the pedal to stop it.

⚠ WARNING

- *Always give a handpiece a light tug after connecting it to its tube to make sure it is securely attached. Otherwise air pressure could blow it off its tube and injure the patient.*
- *Check the lamp for the selected handpiece and its settings. Otherwise, inadvertent operation of a handpiece could result in an injury.*
- *Wait for the handpiece to come to a complete stop before taking it out of or putting it into the oral cavity. Otherwise, there is a danger of injury to the patient.*

Select Constant or Variable Speed

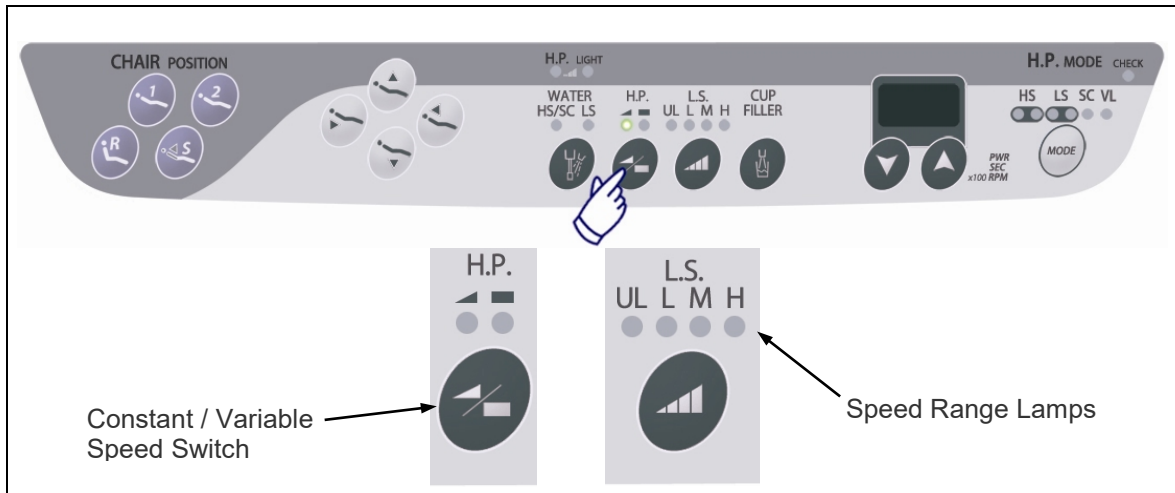

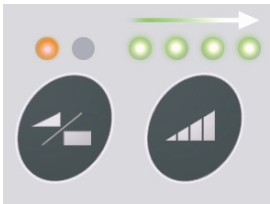
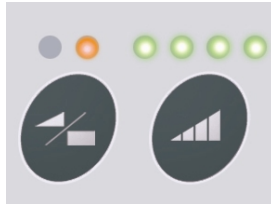
Variable Speed	Constant Speed
	
The farther the pedal is depressed, the faster the handpiece rotates.	Runs at a constant speed

Take the air turbine handpiece out of its holder and set it for either variable speed or constant speed with the HS variable/constant speed switch on the shoulder or tray.

* Air bearing handpieces cut more effectively if they are used at a constant speed.

Usage Note

◆ *The Constant / Variable Speed Switch does not work if the handpiece is actually running.*

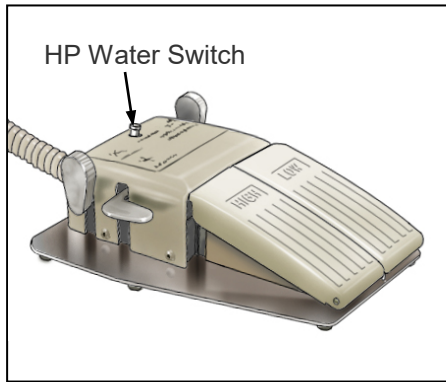

Handpiece Spray

Turn the HP Water Switch on. (Water switches are on the foot control and the tray.)

The HS/SC lamp for the HP Water switch lights up to show the spray is turned on. (Lamps are on the tray.)

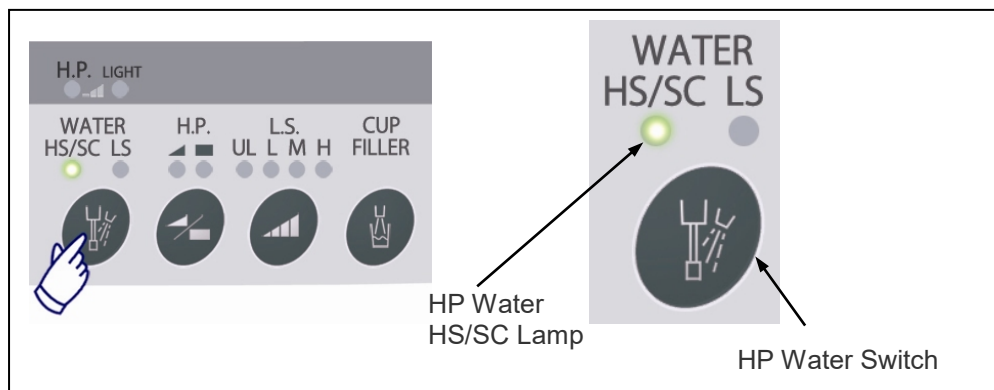

⚠ CAUTION

- *Using the handpiece without spray or with very little spray could cause the treatment area to heat up.*

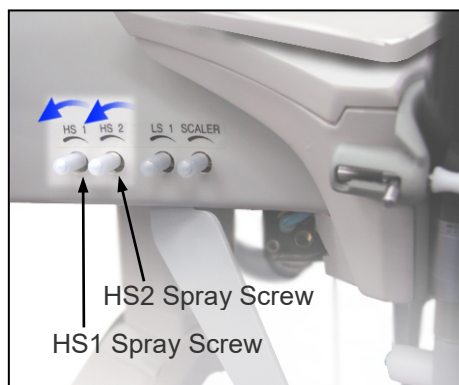

Adjusting the Volume of Spray

Turn the spray adjustment screw for HS1 or HS2 on the left side of the tray in the direction indicated by the arrow to increase the volume of spray.

- * Turn the HP Water switch off to completely stop the spray.



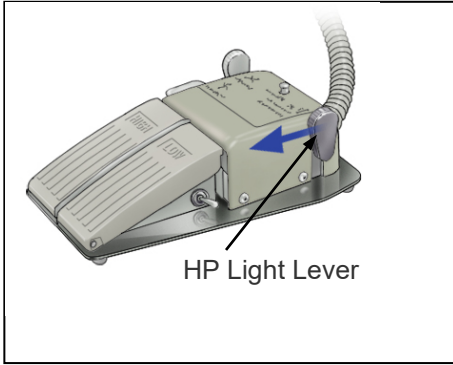

Turning handpiece lights on and off and selecting brightness

Turn the handpiece light on and off with the HP Light lever on the foot control.
 Pull the lever towards yourself and hold it for about 2 seconds until a beep sounds.

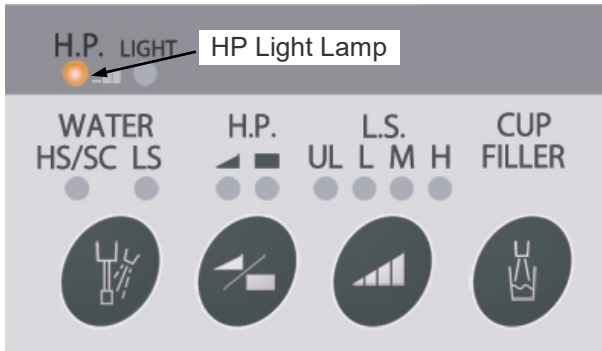

Slightly Dimmer	Bright	Off

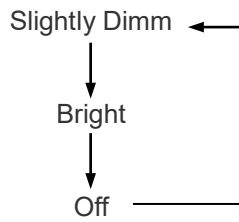

* If you cannot change the HP light setting or if the lamp is blinking, put the three-way syringe all the way back in its holder.

Usage Note

- ◆ *The brightness of the light cannot be adjusted when using MORITA's CP4-LD or CP4-W-LD coupling for the handpiece.*

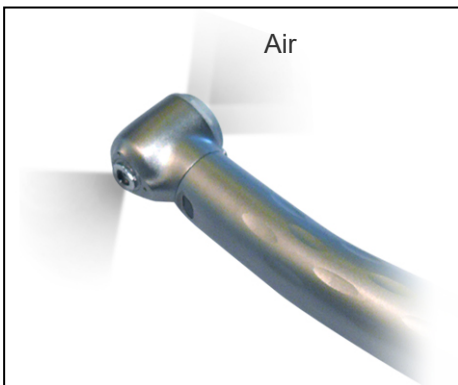

AT • AR Clean System

* This is MORITA's model name of the high speed handpiece clean system.

Air is blown through the head for about 10 seconds after the high pedal is released. This prevents cutting debris, saliva etc. from being drawn into the handpiece water and air tubes.

Safety Circuit

The handpiece safety circuits lock the chair in position whenever the high pedal is depressed.

(7) Micromotor Handpiece: TORX (TR-S2 series) or Air Torx

- * Also refer to the separate user manual for the Micromotor Handpiece and the attachment.

Select Handpiece

Take the handpiece off its hanger; the LS lamp will light up.

- * The first handpiece taken off its hanger has priority so put any other handpiece back on its hanger.

If some other lamp is on even after you take the handpiece off its hanger, use the HP Select switch to select it.

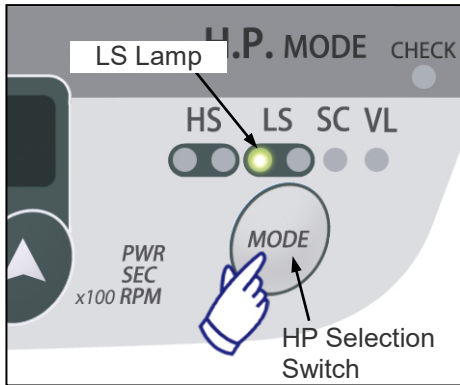

Operation

Take the handpiece out of its holder and step on the low pedal to start the handpiece.

Release the pedal to stop it.

Speed shown in display is in units of 100 rpm.

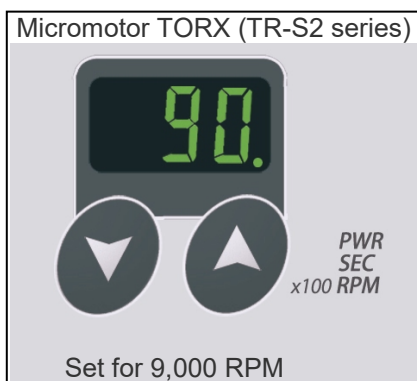
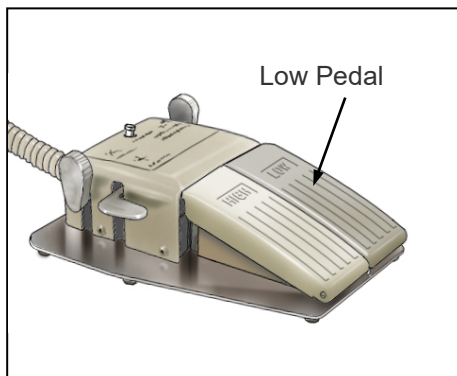

Displayed number times 100.
(90 × 100)

WARNING

- **Make sure the LS lamp is on and check the settings. If another lamp is on, that handpiece will start running and it could injure someone.**
- **Wait for the handpiece to come to a complete stop before taking it out of or putting it into the oral cavity. Otherwise, there is a danger of injury to the patient.**

CAUTION

- **Always give micromotor attachments (straight handpiece, shank, or contra angle) a light tug after attaching them to make sure they are securely attached. Otherwise they could come off and injure the patient.**
- **The micromotor could cause a low temperature burn if it feels hot after or during long, continuous use. Stop using it and wait for it to cool off if it feels hot.**
- **Do not use attachments that are worn out or otherwise defective; they could overheat and cause a burn.**

Usage Note

- ◆ *Do not fail to remove excess oil after lubricating the straight, shank and head attachments. Otherwise, the oil could seep into the motor and damage it.*

Micromotor Safety Circuit

Chair is locked in position and cannot move when Low pedal is depressed.

Constant or Variable Speed

Pull the micromotor handpiece out and press the Constant / Variable Speed Switch

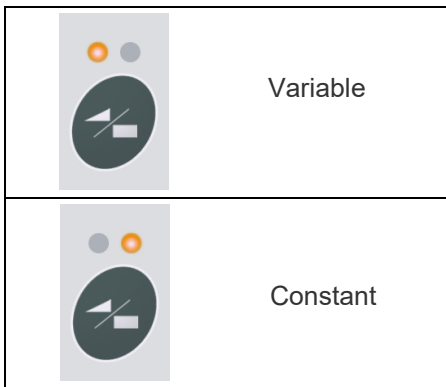

Selecting Speed Ranges for the TORX (TR-S2 series)

Use the LS speed range switch to select speed ranges.

The ultra-low and low ranges (100 to 3,000 rpm) are especially good for very precise control.

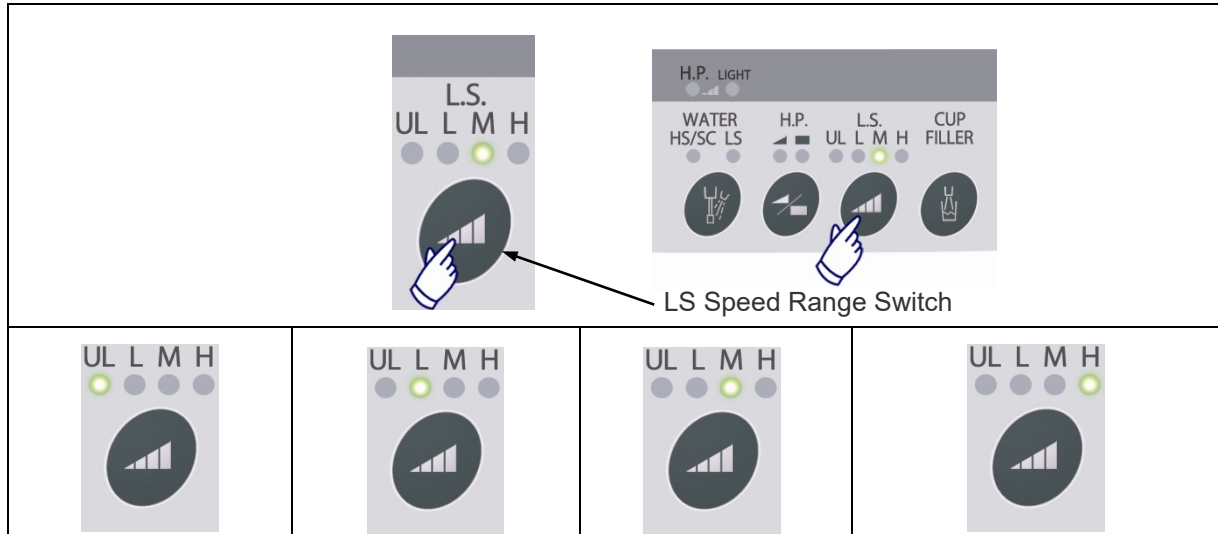

Speed			
<p>ULTRA LOW Approx. 100 to 300 rpm * No tip air. * Factory Setting: 250 rpm</p>	<p>LOW Approx. 100 to 3,000 rpm * No tip air.</p>	<p>MEDIUM Approx. 100 to 20,000 rpm * Tip air emitted. * Factory Setting: 9,000 rpm</p>	<p>HIGH Approx 100 to 40,000 rpm * Tip air emitted</p>

* The chart above shows the factory settings for tip air. Tip air can be turned on and off by holding down the speed range switch for about 2 seconds.

* Water spray is emitted when the spray is turned on.

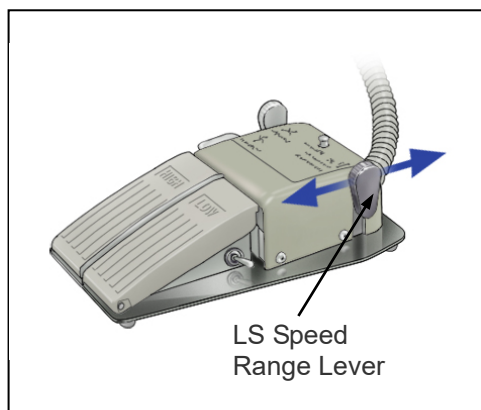

A lever on the foot control can also be used to set the speed range.

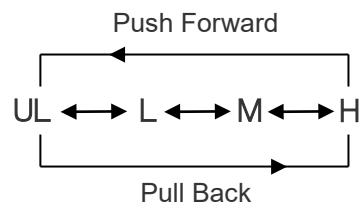











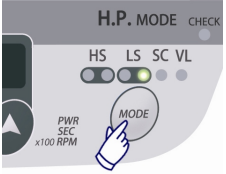





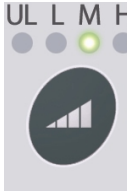

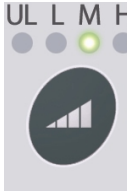

Usage Note

◆ *The speed range switch does not work if handpiece is actually running.*

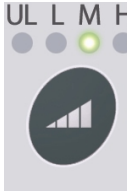
* The speed for the Air Torx is set with a dial on the handpiece itself.

Set Speed for the Micromotor Handpiece

Set the micromotor for either constant or variable speed.
The constant speed for each speed range can also be set.

<p>1. Select Micromotor</p> 	<p>Speed Display</p>  <p>Shows approximate speed when motor is running with no load</p>  <p>HP Constant / Variable Speed Switch Speed Range Switch</p>															
<p>2. Speed Ranges</p>  <p>Press the Speed Range Switch</p>	<p>Speed Ranges</p> <table border="1" data-bbox="354 763 1385 1167"> <thead> <tr> <th data-bbox="354 763 616 813">ULTRA LOW</th> <th data-bbox="616 763 871 813">LOW</th> <th data-bbox="871 763 1126 813">MEDIUM</th> <th data-bbox="1126 763 1385 813">HIGH</th> </tr> </thead> <tbody> <tr> <td data-bbox="354 813 616 1043">  </td> <td data-bbox="616 813 871 1043">  </td> <td data-bbox="871 813 1126 1043">  </td> <td data-bbox="1126 813 1385 1043">  </td> </tr> <tr> <td data-bbox="354 1043 616 1167"> <p>100 to 300 rpm Variable * Factory Setting: 250 rpm</p> </td> <td data-bbox="616 1043 871 1167"> <p>300 to 3,000 rpm Variable</p> </td> <td data-bbox="871 1043 1126 1167"> <p>2,000 to 20,000 rpm Variable * Factory Setting: 9,000 rpm</p> </td> <td data-bbox="1126 1043 1385 1167"> <p>5,000 to 40,000 rpm Variable</p> </td> </tr> </tbody> </table>				ULTRA LOW	LOW	MEDIUM	HIGH					<p>100 to 300 rpm Variable * Factory Setting: 250 rpm</p>	<p>300 to 3,000 rpm Variable</p>	<p>2,000 to 20,000 rpm Variable * Factory Setting: 9,000 rpm</p>	<p>5,000 to 40,000 rpm Variable</p>
ULTRA LOW	LOW	MEDIUM	HIGH													
																
<p>100 to 300 rpm Variable * Factory Setting: 250 rpm</p>	<p>300 to 3,000 rpm Variable</p>	<p>2,000 to 20,000 rpm Variable * Factory Setting: 9,000 rpm</p>	<p>5,000 to 40,000 rpm Variable</p>													
<p>3. Constant Speed</p>  <p>Blinks</p> <p>Press the Up or Down switch under the display to set the constant speed (Dot after number blinks to show that setting is possible.)</p>	 <p>Example Set for approx. 200 rpm (Setting range: Approx. 100 to 300 rpm)</p> <p>RPM Increment / Decrement: 10</p>	 <p>Example Set for approx. 2,000 rpm (Setting range: Approx. 300 to 3,000 rpm)</p> <p>RPM Increment / Decrement: 100</p>	 <p>Example Set for approx. 7,000 rpm (Setting range: Approx. 2,000 to 20,000 rpm)</p> <p>RPM Increment / Decrement: 500</p>	 <p>Example Set for approx. 30,000 rpm (Setting range: Approx. 5,000 to 40,000 rpm)</p> <p>RPM Increment / Decrement: 1000</p>												

Usage Note

- ◆ *Running speed may increase when a load is applied.*
- ◆ *Use a speed reducing contra for the crown down endodontic treatment. Speed may change when load is applied.*
- ◆ *Display shows motor speed, not the speed of the burr when used with a contra head that increases or decreases the speed.*

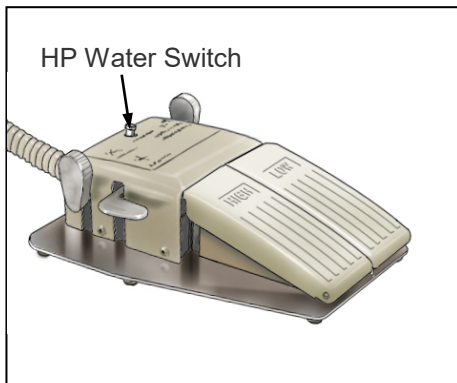

Spray

Turn the spray on by taking the handpiece out of its holder and pressing one of the HP Water switches, which are located on the foot control, the shoulder, and the tray. The lamps for the HP Water, LS, will light up when the spray is on.

CAUTION

- *Using the handpiece without spray or with too little spray could cause the treatment area to get too hot.*

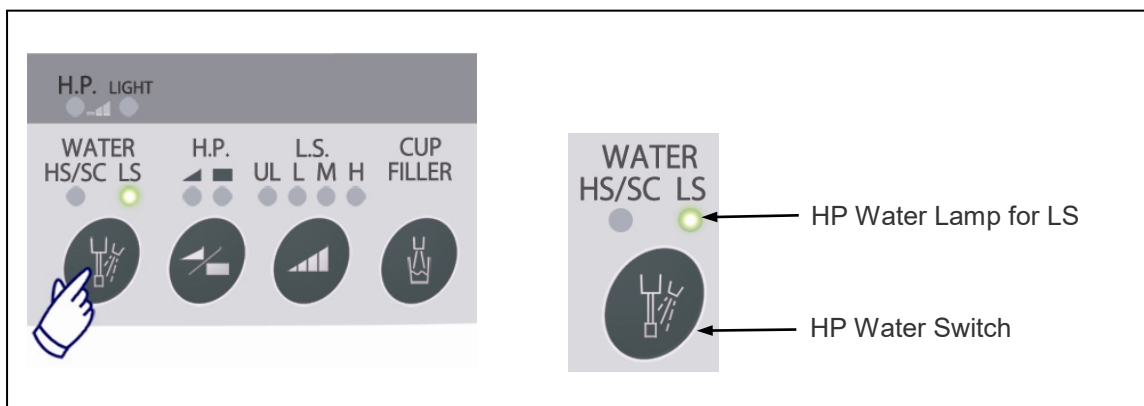

Spray Water Volume

Turn the micromotor spray screw in the direction indicated by the arrow to increase the volume of the spray.

Forward / reverse Changeover: TORX (TR-S2 series)

Set the direction of the rotation with the Forward / Reverse Switch on the foot control.

Push Forward ----- Forward Rotation

Pull Back ----- Reverse Rotation

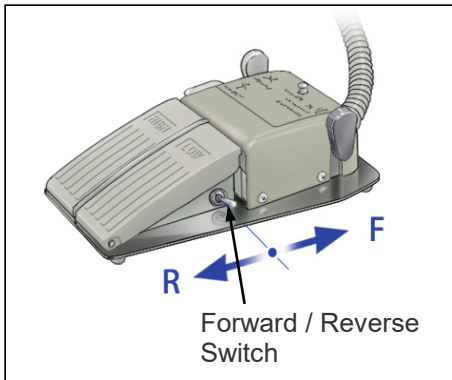

⚠ CAUTION

- *Check the forward / reverse setting before using the micromotor.*

Usage Note

- ◆ *Never operate this changeover switch while the handpiece is actually running.*
- ◆ *The micromotor may not run if the forward / reverse switch is set in the middle, i.e., not completely to one side or the other.*

* For the Air Torx, the forward and reverse setting is made by adjusting the handpiece itself.

Light-equipped Handpieces

See page 36 for instructions on how to turn the light on and off and how to adjust the brightness.

(8) Threeway Syringes

1) Threeway Syringe

This syringe can be used for air, water, or mixed air and water spray.

Water Spray

Press both the air and water levers simultaneously for a fine, water spray.

Water

Press the water lever for water.

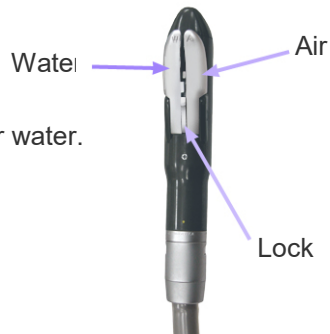

Air

Press the air lever for air.

When water is not needed, slide the lock located between the air and water levers down to lock the water lever.

Usage Note

- ◆ *Always lock the water lever before putting the syringe away to prevent leaking.*

Light-equipped Handpieces

Push the nozzle into or pull it out of its holder.

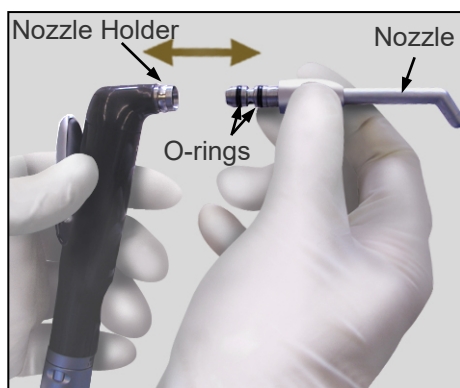

⚠ CAUTION

- *Make sure that the nozzle clicks securely into place. Otherwise, the nozzle could be blown off the end of the syringe.*

Usage Note

- ◆ *Right after inserting the nozzle, a little water may come out when the air lever is pressed; press the air lever 2 or 3 times before using the syringe.*
- ◆ *Coat the O-rings with vaseline if the nozzle is hard to remove.*

Taking Off and Putting On the Syringe Case

[Put on]

Match the blue marks on the case and body, and push them until they click together. Make sure the syringe case is securely connected.

Usage Note

- ◆ *Coat the O-rings with vaseline if it gets hard to take the case off and put it back on.*
- ◆ *Make sure the Ring A in the photo is securely tightened up.*

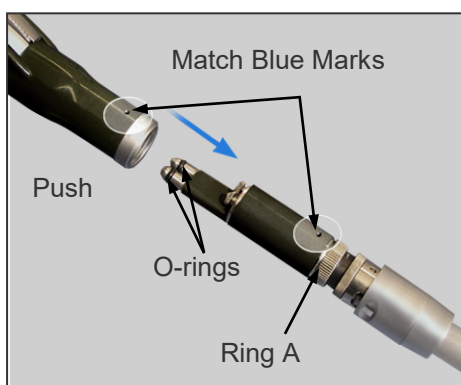

[Take off]

Press down on the indented part of the syringe tube connector and pull the syringe case off the body.

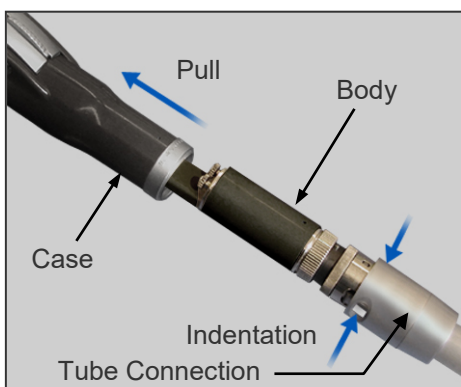

⚠ CAUTION

- *Make sure the three-way syringe case and body are securely attached to each other. Otherwise, the case could slip off when you take it out of its holder and strike the patient in the face.*

2) Threeway Syringe (with light) (option)

This syringe delivers air, water, and a spray of mixed air and water.

Light and Spray

Press both the air and water levers to turn on both the light and the spray.

Water

Press the water lever for water

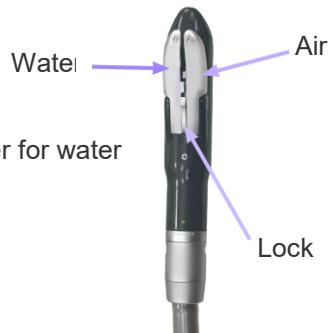

Light and Air

Press the air lever slightly to turn the light on. Press it down further to emit air. The Air lever doubles as a light switch.

Slide down the lock between the air and water levers down to lock the water lever.

Usage Note

- ◆ *Always lock the water lever before putting the syringe away to prevent leaking.*

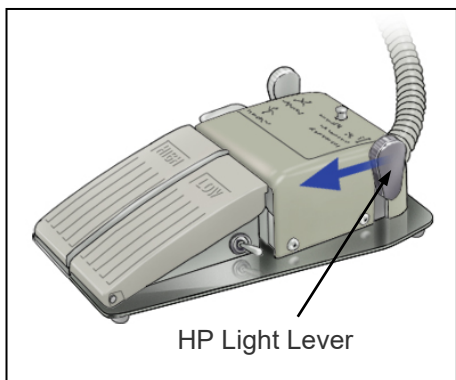
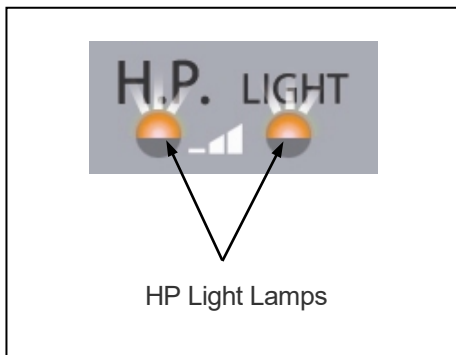

Turn On and Off

Pull the syringe out and turn on its light with the lever on the foot control.

The lamps blink when the light is turned on.

- * Make sure other instruments are all putaway in their holders.

Pull the lever back and hold it for about 2 seconds until a beep sounds to turn the light on and off.

CAUTION

- *If the light is used continuously by itself, it could get hot enough to cause a burn. Blow air for about 30 seconds to cool the nozzle off.*

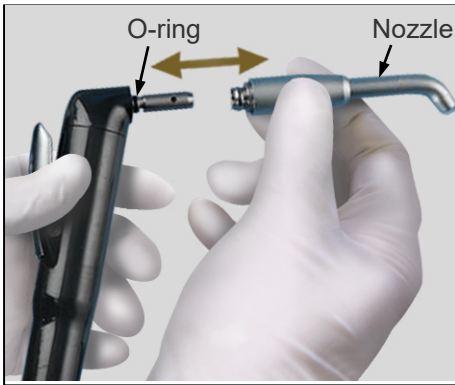

Nozzle Attachment and Removal

Push the nozzle into the syringe or pull it out.

⚠ CAUTION

- *Make sure there is an audible click when putting the nozzle on the three-way syringe and that the nozzle is securely fixed to the syringe. Otherwise, the nozzle could be blown off and injure someone.*
- *Remember that the lamp and lamp cover are extremely hot right after the lamp has been turned off. Do not touch these parts; they could cause a burn.*

Usage Note

- ◆ *A little water may come out of the three-way syringe when the air lever is pressed right after the nozzle has been attached. Press the air lever 2 or 3 times to expel all the water.*
- ◆ *Coat the nozzle's O-rings with vaseline if it is hard to attach and remove.*

Taking Off and Putting On the Syringe

[Put on]

Match the yellow marks on the syringe and tube connector and push them together until they click. Make sure the syringe is securely connected.

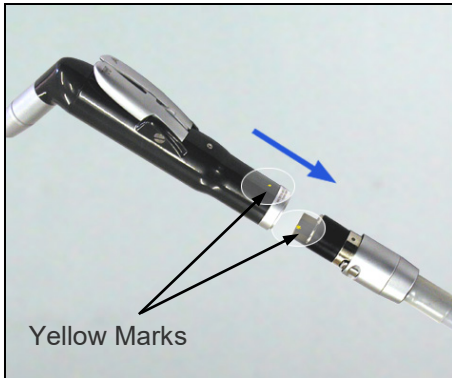

[Take off]

Press down on the indented part of the syringe tube connector and pull the syringe case off the body.

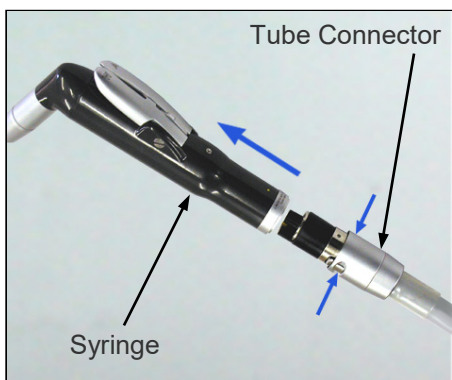

CAUTION

- *Make sure the threeway syringe is securely attached to its tube. Otherwise, it could slip off when you take it out of its holder and strike the patient in the face.*

- * Put the cap on the lamp cover to autoclave the syringe.

CAUTION

- *Always put the cap on the lamp cover to autoclave the syringe; otherwise, the LED might be ruined.*

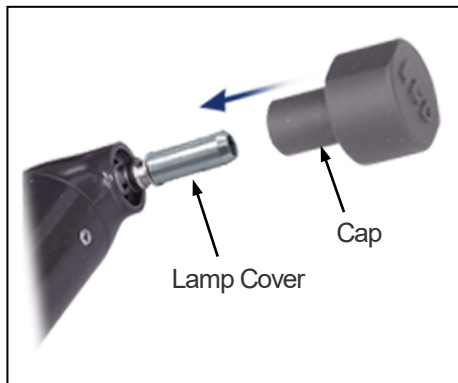

Usage Note

- ◆ *Coat the threeway syringe's O-rings with Vaseline if it is hard to attach and remove.*
- * Slide the cap provided securely onto the tube connector after taking off the syringe. This prevents the connector from going too far down into its holder.

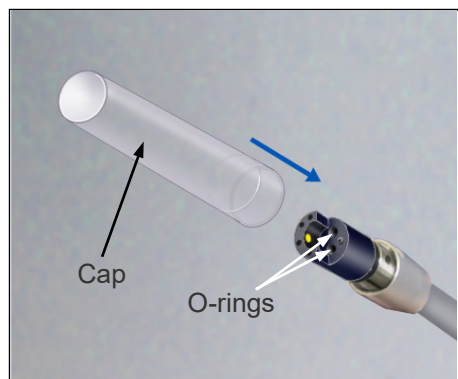

(9) Vacuum Syringe

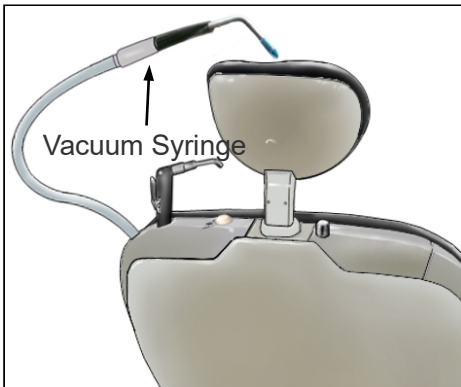

Operation

The vacuum syringe begins to operate when it is pulled out of the syringe holder panel, and stops a few seconds after it is returned to its holder.

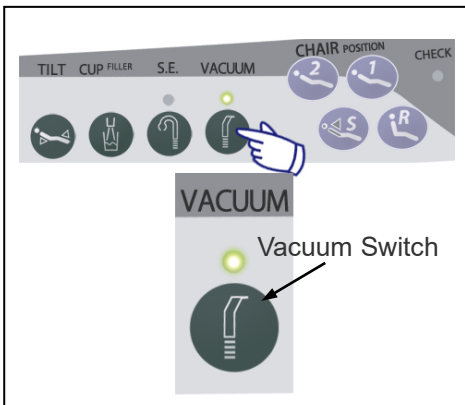

It can also be turned on and off with the vacuum switch.

- * When the syringe is used continuously and sucks in matter faster that it can drain out of the tank, the tank will fill up and the float switch will shut off the vacuum. If this happens, put the vacuum syringe in the its holder and wait until the tank has drained.

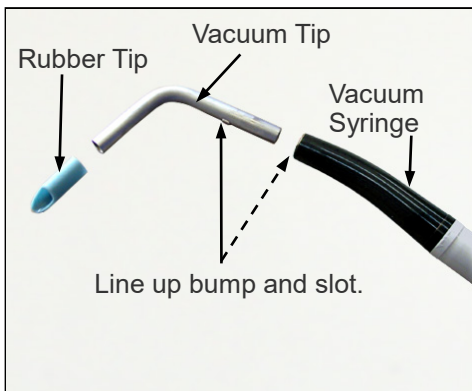

Vacuum and Rubber Tips

Pull the vacuum tip straight out of the syringe body; reinsert the vacuum tip by lining up the bump on the tip with the slot in the syringe body and sliding it straight in. Slide the rubber tip straight onto and off of the vacuum tip.

Usage Note

- ◆ *Coat the O-ring inside the vacuum syringe with a little vaseline if the vacuum tip is hard to put in and take out.*
- ◆ *Do not twist the vacuum tip with excessive force.*

Putting on and taking off the syringe body (screw type)

[Put on]

Hold the tube connector and screw the body all the way into place.
Make sure the syringe is securely fastened.

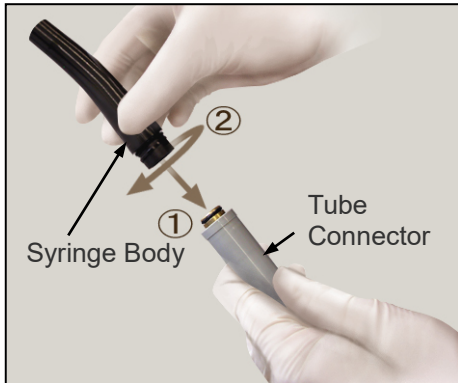

⚠ CAUTION

- *Make sure the syringe body is securely attached to its tube; otherwise it might come off when you pull it out and you could accidentally hit the patient in the face.*

[Take off]

Hold the tube connector, rotate the body in the direction shown by the arrow and pull it off.

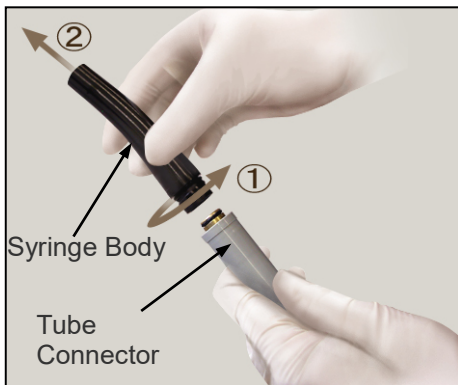

Usage Note

- ♦ *Always turn the body to take the syringe off and put it on. Turning the tube connector could damage it.*

* Change the Angle of the Syringe

Lower the tube connector without turning the main tube
Turn it so that the mark is facing up and then raise it back up to its original position.

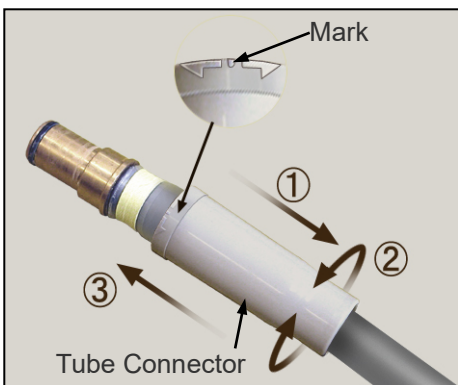

(10) Basin

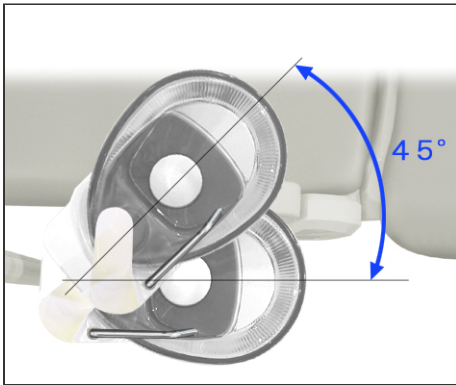

Basin Position

The basin may be rotated 45° towards the patient. Return the basin to its original position after each patient.

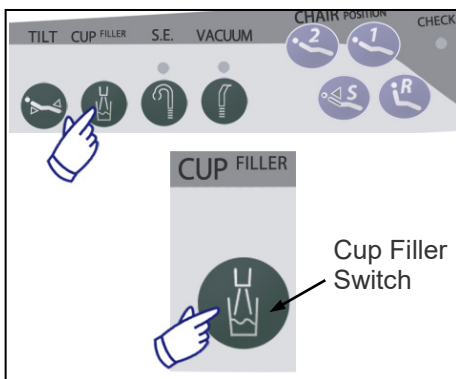

Manual Cup Filling

Water will fill the cup as long as the shoulder or tray cup filler switch is being held down.

Usage Note

- ◆ *Water will splash out of the basin if a cup is not in place when the cup filler switch is pressed.*

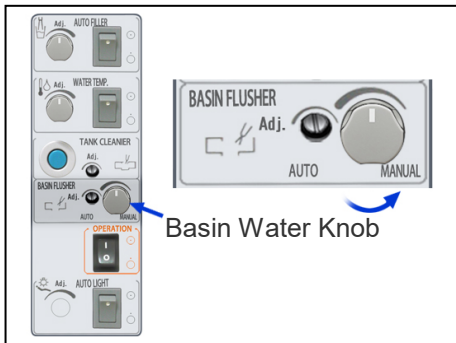

Manual Basin Rinsing

Open the maintenance box. Turn the Basin Water Knob in the direction indicated by the arrow in the photo to rinse out the basin.

Turn it in the opposite direction to turn the water off.

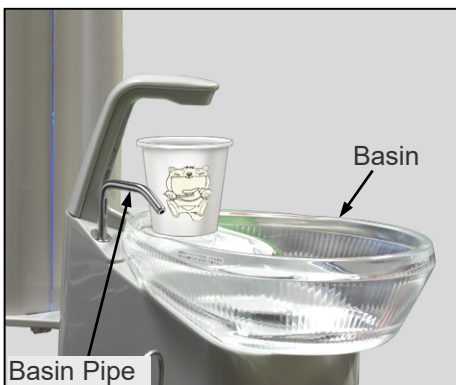

Usage Note

- ◆ *Make sure that the basin pipe is pushed all the way in and that it points into the basin.*

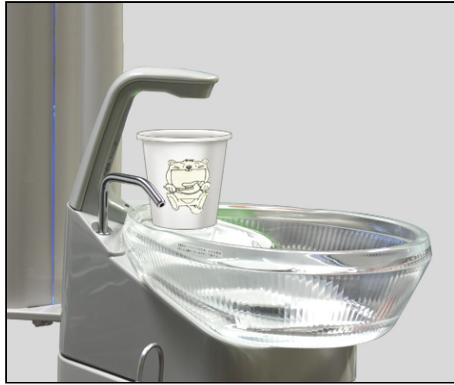

Auto Cup Filler (option)

A sensor detects when a cup has been placed on the cup holder, and the cup is automatically filled with water. At the same time, the basin is automatically rinsed for about 15 seconds

- * Paper cups may also be used.
(Use same type as those originally provided.)
- * Cups may also be filled by pressing the cup filler switch.

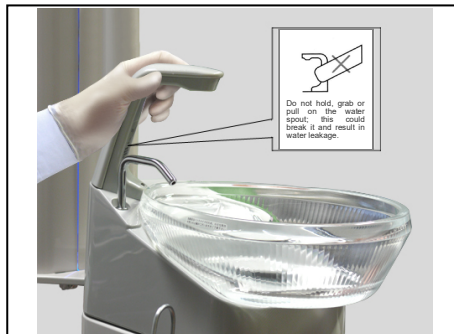

Usage Note

- ◆ *If a full cup of water is left in place and the main switch is turned off and on again, a little water will flow into the cup until the water level is detected.*
- ◆ *Transparent or partially transparent cups may NOT be detected by the light sensor and, as a result, may not be filled with water.*
- ◆ *Do not hold, grab or pull on the water spout; this could break it and result in water leakage.*

Do not hold, grab or pull on the water spout; this could break it and result in water leakage.

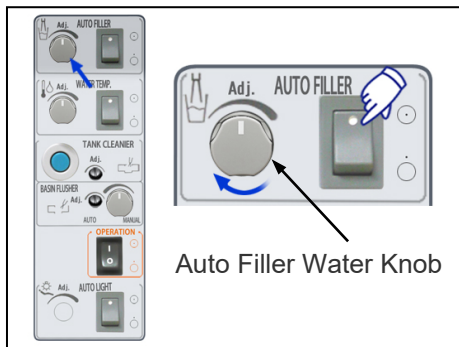

Water Volume for the Auto Cup Filler

Open the maintenance cover. Adjust the amount of water the auto filler delivers with the Auto Filler Water Knob. Turn it in the direction indicated by the arrow to increase the amount.

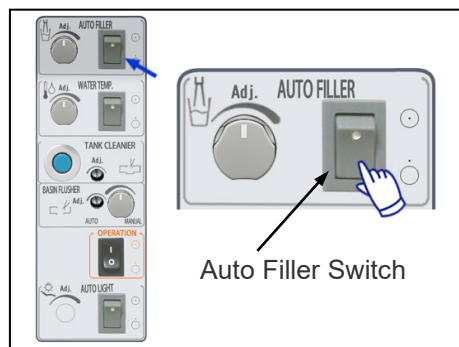

Turn Auto Filler Off

The Auto Filler Switch inside the maintenance cover turns it on and off. Use the Cup Filler switch when the Auto Filler is turned off.

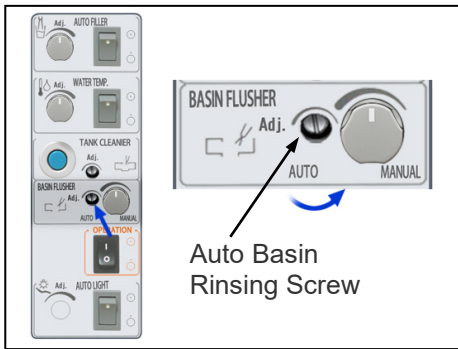

Adjust Basin Rinse Water
(only when using auto cup filler)

When the Auto Cup Filler is used, the basin is rinsed for 15 seconds after the cup is filled. The amount of water used can be adjusted by turning the Auto Basin Rinsing Screw inside the maintenance cover with a screwdriver. Turn the screw in the direction show by the arrow to increase the flow of water.

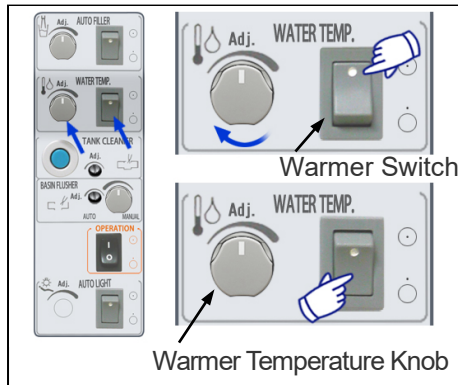

Warmer Temperature

Turn the warmer temperature knob inside the maintenance cover in the direction shown by the arrow to increase the temperature.

Warmer Off

If the warmer is not needed during warm weather, turn it off with the warmer switch.

(11) Snap-On Tube Connections (drain connector is an option)

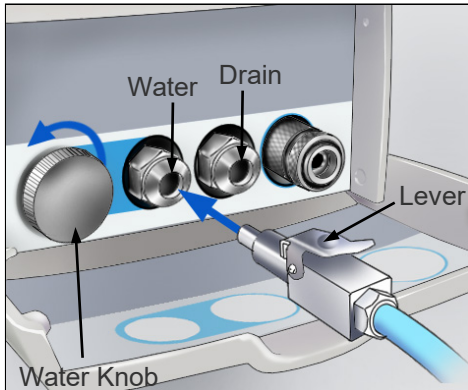

Water and Drain Connections

[Connect]

Push the connector in until its hook locks into place.

Adjusting the Water Supply

Turn the water valve in the direction indicated by the arrow to increase the water supply.

CAUTION

- *Turn off the main water valve after use to avoid the risk of leakage.*

Usage Note

- ◆ *Do not mix up the water and drain connectors; this could result in a leakage of water.*

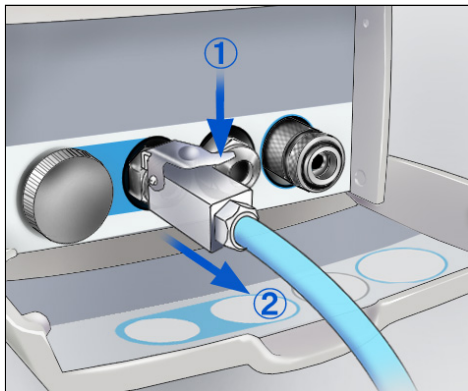

[Disconnect]

Hold down the lever on the tube connection; then pull the connector straight out.

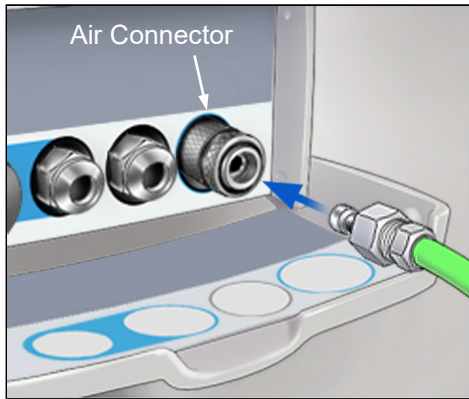

Air

[Connect]

Push the tube connector straight in.

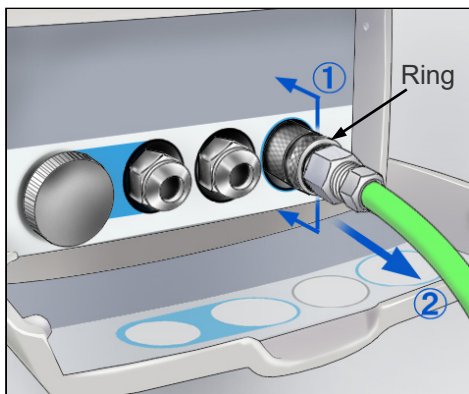

[Disconnect]

Push in the connection ring and then pull the connector straight out.

- * When you pull the tube out, you will hear the sound of air coming out of it.

(12) Saliva Ejector (option)

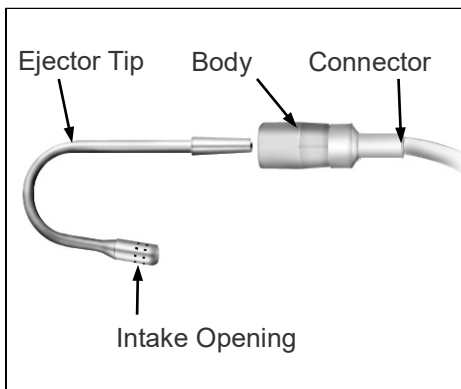
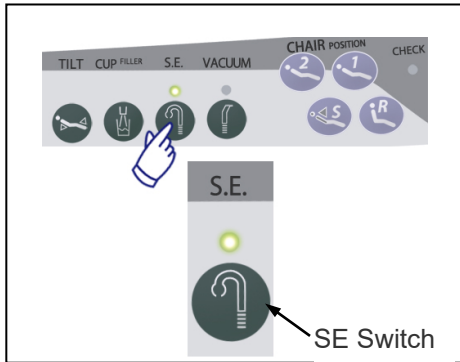
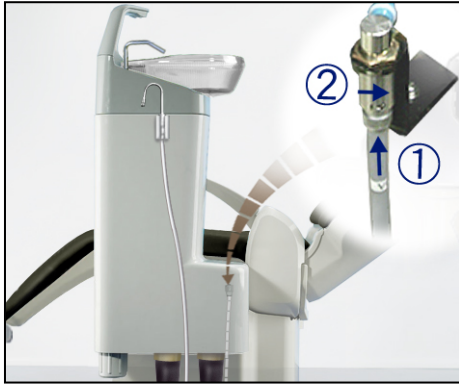

Connect Tube

Plug the connector on the ejector's tube into the its connection

Operation

The ejector starts when it is taken off its hanger and stops when it is put back.

It is also possible to press the SE Switch to operate it when it is off its hanger.

Ejector Tip and Body

[On]

Simply slide the tip into the body.

[Off]

Pull the tip out of the body.

* Intake opening may be unscrewed and taken off.

Usage Note

◆ *Make sure the tube and ejector body are properly and securely connected.*

(13) Assistant Instrument Holder (option)

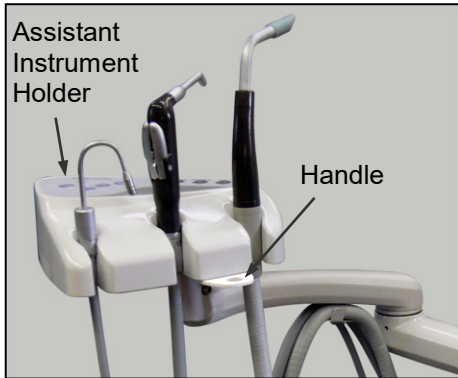

Use the handle to move the instrument holder.

Usage Note

- ◆ *Do not pull on the tubes with too much force.*

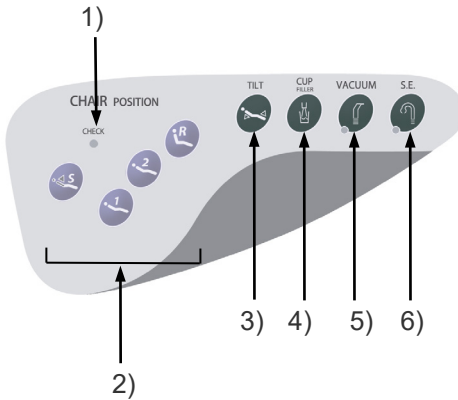

* See below for description and explanation of switches etc.

- 1) Check Lamp
See page 19 for explanation of safety switches.
- 2) Chair Auto Positioning Switches
See pages 20 and 23 for using these switches and for memorizing positions.
- 3) Tilt Switch
See page 21.
- 4) Cup Filler Switch
See page 50 for how the manual cup filler works.
- 5) Vacuum Switch
The vacuum turns on when the syringe is picked up and turns off when it is returned to its holder.
See page 48 for details on using the vacuum.
- 6) Saliva Ejector Switch
Use this to turn the saliva ejector on and off. See page 55.

* See page 43 for how to use the threeway syringe.

(14) Assistant's Auxiliary Tray (option)



A convenient place to put things.

Usage Note

- ◆ *Do not put objects that weigh more than about 1 kilogram on this tray. They could fall or damage something.*

(15) Small Tray (option)



A convenient place to put things.

Usage Note

- ◆ *Do not put objects that weigh more than about 1 kilogram on this tray. Also do not lean on it or bump against it. It could fall and damage something.*

(16) PdW Tray



Usage Note

- ◆ *Do not place heavy objects (more than 2kg) on the tray. The top of the tray could tilt resulting in the spillage of medicine or other accidents.*
- ◆ *If any chemicals (e.g., Creodon, phenol camphor, phenol thymol, formalin cresol, arcrinol, xylocaine, cresol liquid soap, saphoride, iodine glycerite etc.) are spilled on the tray or instrument hanger, wipe them off immediately with ethanol.*
(These chemicals can damage and discolor surfaces.)

Tray Positions

This tray can be set for use anywhere from the 9 o'clock position to the 12 o'clock position. Grip the handle to move it.

- * Optional mouse tray is designed for a mini-mouse.

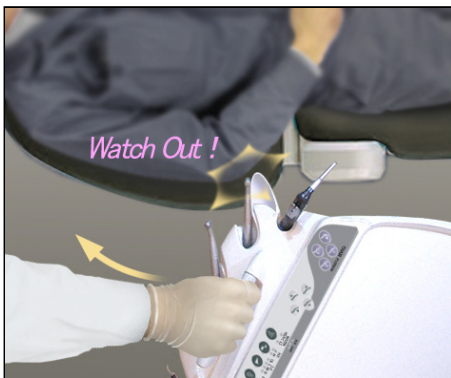
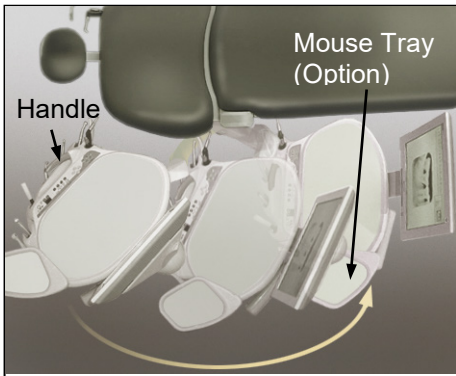

⚠ WARNING

- *If you leave a burr, file or tip in a handpiece, take care that you do not injure the patient or yourself when you remove the handpiece or when you move the tray.*

⚠ CAUTION

- *Be careful not to injure yourself when removing a handpiece when another handpiece has a burr in it.*

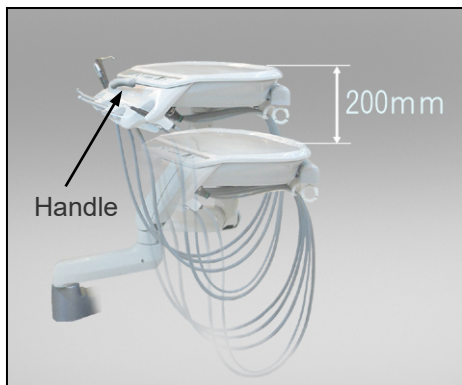

Vertical Position

Hold the handle and carefully move the tray up or down.

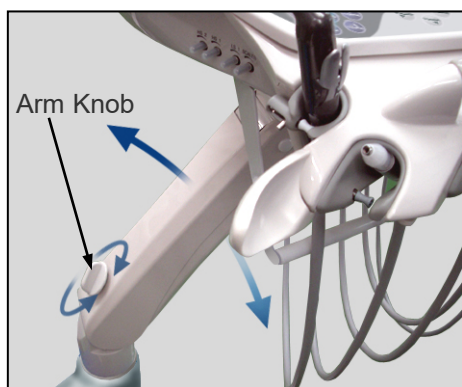

Turn the arm knob clockwise to set the arm's vertical position.

Usage Note

- ◆ *If the arm knob is not properly tightened up, the tray could suddenly drop down, resulting in spilled medicine, fallen instruments or other accidents.*

Handpiece Holders

Take the handpiece holder off and autoclave it.

[Remove]

< Handpiece >

- (1) Hold down the release lever.
- (2) Pull the holder forward as far as it will go.
- (3) Lower it to take it off.

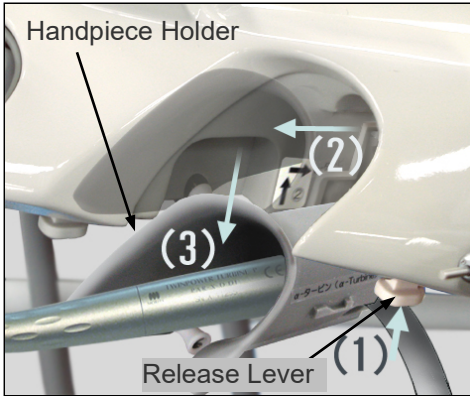

< Threeway Syringe >

- (1) Hold down the release lever.
- (2) Pull the holder up.

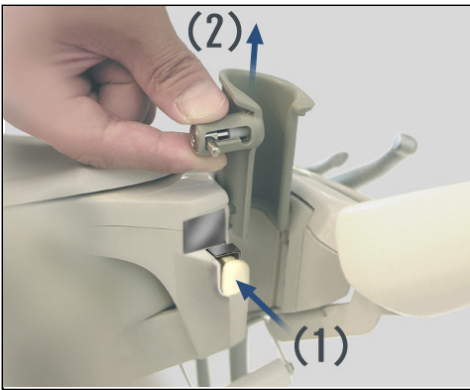

- (1) } Open the lever on the holder.
- (2) }
- (3) Take the tube out of the holder.

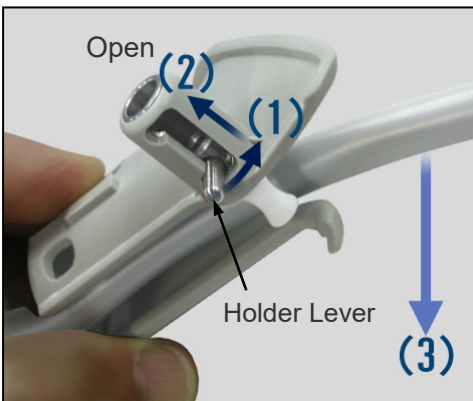

[Attach]

- * Match the number of the holder with the number of the instrument hanger.

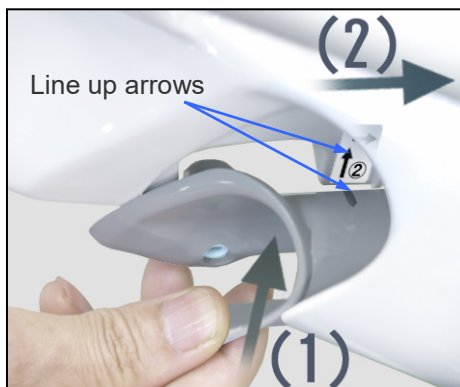
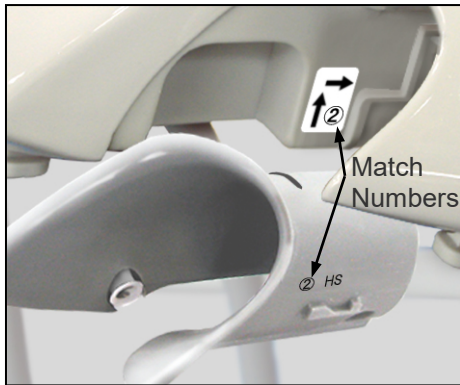

< Handpiece ①, ②, ③ >

- (1) Match the arrows from underneath and then push the holder up as far as it goes.
- (2) Push it until it clicks into place.

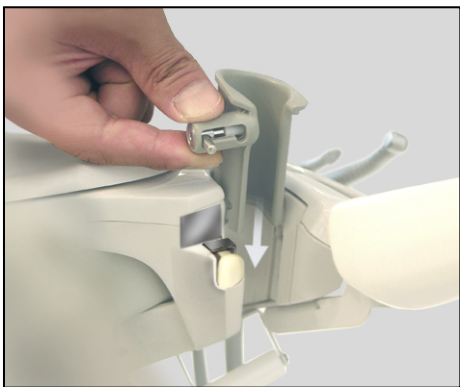

< Threeway Syringe ① >

Push the holder firmly in as far as it will go.

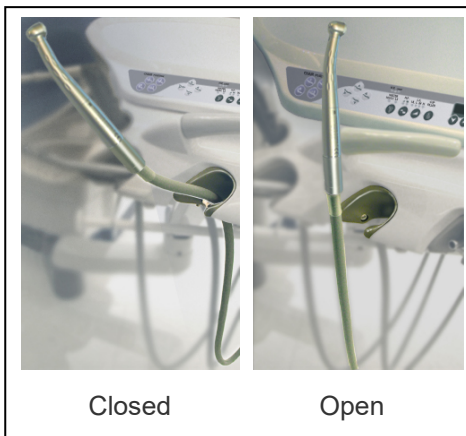

Route the tube through the holder and close the holder's lever.

- * The instruments can also be used with the lever left open.

⚠ CAUTION

- *Do not fail to match the numbers for the holders.*
- *Make sure the holder is all the way in and locked in place and that the sensor detects it. Check the handpiece selection switch.*

Usage Note

- ◆ *If any chemicals (e.g., Creodon, phenol camphor, phenol thymol, formalin cresol, arcrinol, xylocaine, cresol liquid soap, saphoride, iodine glycerite etc.) are spilled on the tray or instrument hanger, wipe them off immediately with Ethanol for Disinfection (Ethanol 70to80 vol%). (If left for a long time, these chemicals can damage and discolor surfaces.)*

Handpiece Holders

Pull off the handle and handpiece guard and autoclave them.

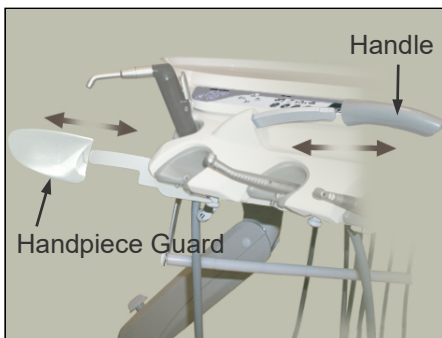

Tray Sheet

Spread the silicone sheet on the tray and place the waste cup holder, and the medicinal vial holders on the sheet. (These accessories are all autoclavable.)

Usage Note

- ◆ *If any chemicals (e.g., Creodon, phenol camphor, phenol thymol, formalin cresol, arcrinol, xylocaine, cresol liquid soap, saphoride, iodine glycerite etc.) are spilled on the tray sheet or holders, wipe them off immediately with Ethanol for Disinfection (Ethanol 70to80 vol%). (If left for a long time, these chemicals can damage and discolor surfaces.)*



(17) Dental Operating Light: Luna Vue LD

* Also refer to the separate user manual for the Luna Vue LD.

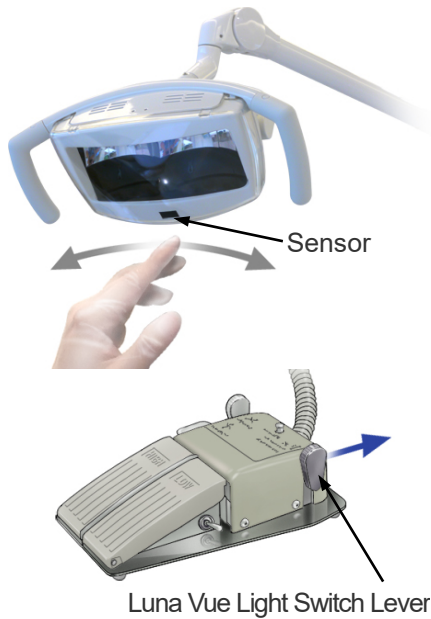

Turn On and Off

Move your hand in front of the sensor to turn the light on and off.

You can also be able to turn it on and off with a switch on the foot control.

Push the lever forward and hold it there for about 2 seconds until a beep sounds.

Brightness Adjustment

Put away all the handpieces and then hold down the HP Mode Switch until an audible signal sounds. You can now set the brightness level.

The brightness level appears in the LCD. There are eight levels from L1 to L8. Larger numbers are brighter.

Press the Scaler Power Switch to set the level. (The foot control cannot be used for this.)

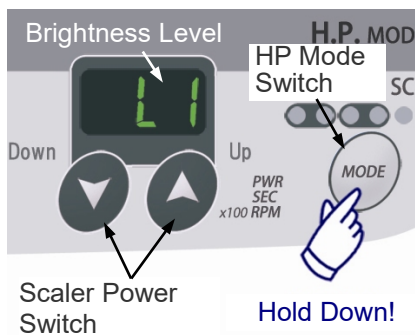

Four brightness levels can be memorized.

(1) Select a speed range (UL, L, M, or H) and then set the brightness level with the Scaler Power Switch.

(2) The brightness levels for each speed range will be memorized when you leave the brightness setting mode.

Use the LS speed switch to recall a memorized brightness level. The brightness level will appear in the LCD.

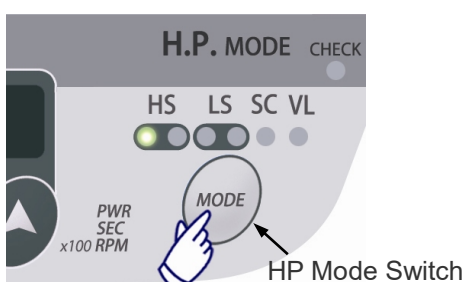
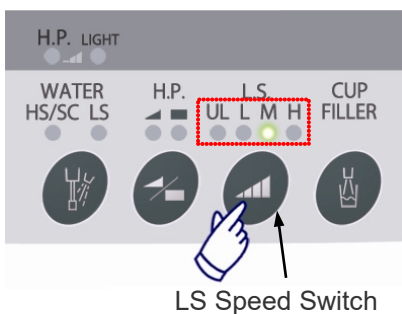

There are 3 ways to leave the brightness adjustment mode:

- * Press the HP Mode Switch
- * Pull out any instrument except the three-way syringe
- * Wait for 10 seconds without touching the brightness level or brightness memory switches

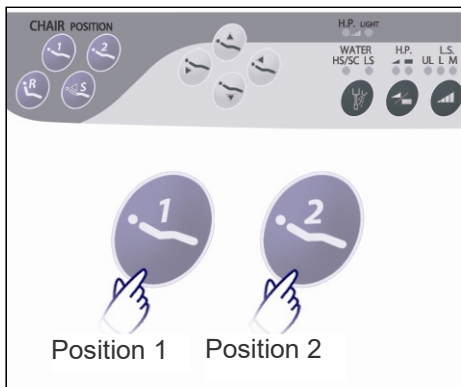

Brightness Adjustment (option)

When set on automatic, the light comes on when the chair moves into positions 1 or 2. It goes out in positions R or S.

Turning On the Auto Light (option)

Turn the light on.
Open the maintenance cover.
Turn the auto light switch on to have the light turn on automatically in positions 1, 2, and SR.

- * Turn the auto light switch off if the auto light function is not needed or desired.

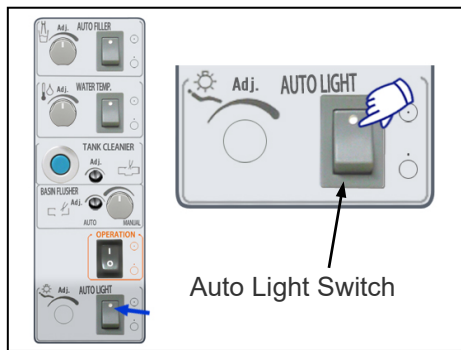

(18) Ultra Sonic Scaler: Solfy F (Built-in Model) (option)

* Also refer to the separate user manual for the Solfy F Built-in Model.

Select Scaler Handpiece

The scaler will be selected and its lamp will light up when its tube is connected. If other lamp is on, use the HP MODE switch to select the scaler.

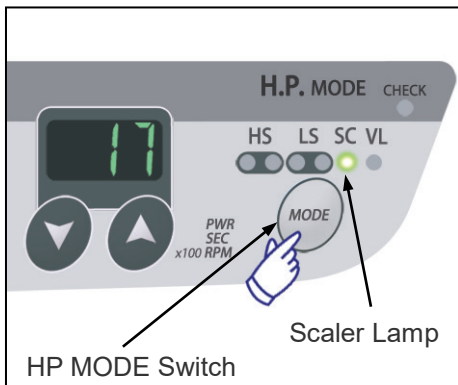

Handpiece Spray

Turn the spray on and off with the HP Water switch on the side of the tray or the one on the foot control. The HS / SC Water Lamp lights up when the spray is turned on. Step on the High pedal to vibrate the tips and emit a stream of spray simultaneously.

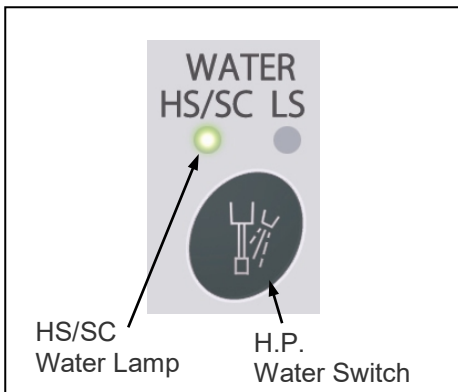

Spray Volume Adjustment

Turn the scaler's Water Screw in the direction shown by the arrow to increase the amount of water.

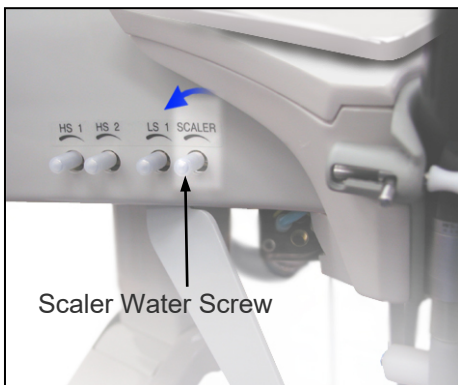

⚠ WARNING

- *Adjust the volume so that a fine mist spray comes to the scaler tip.
It is dangerous to use the scaler if the water is not adjusted adequately. The treatment area could be overheated and injure the patient. This also results in overheating the scaler tip and it could be damaged.*

Power Adjustment

Press the power switches (UP or DOWN) on the shoulder or the tray to adjust the power setting.

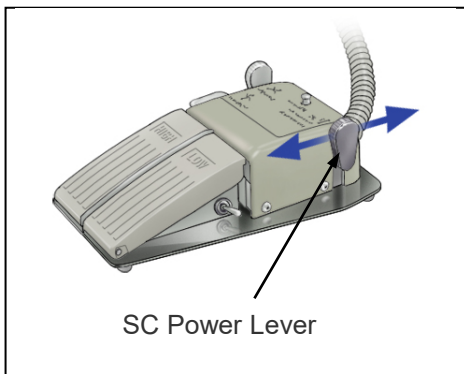
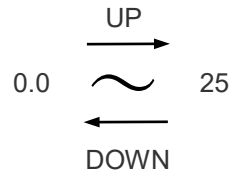
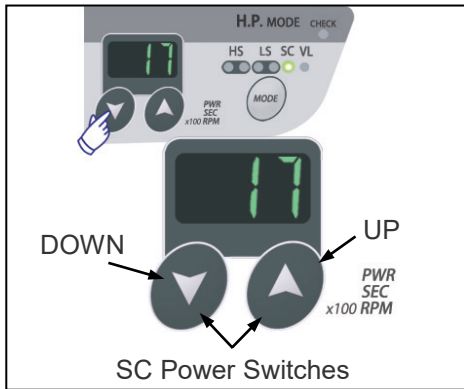

The lever on the foot control can also be used to adjust the power.

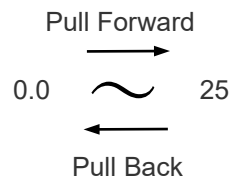

WARNING

- *Do not use the scaler at powers higher than those recommended or apply the tip with excessive force; these actions could result in injuring the patient or damaging the scaler handpiece.*

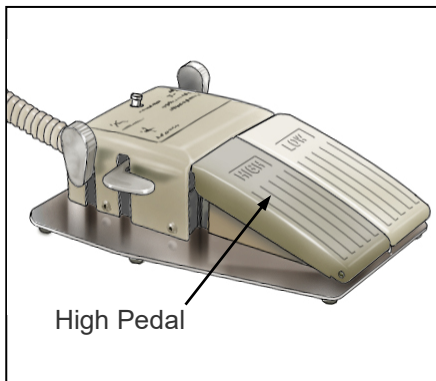

Tip vibration

Step on the High Pedal to vibrate the tip.
Release the pedal to stop.



The LS Speed lamps blink while the scaler is running.

⚠ WARNING

- ***Make sure the scaler lamp is on and other settings are OK. Otherwise, another instrument might start operating and injure the patient.***
- ***Wait for the tip to stop vibrating before putting it into or taking it out of the patient's oral cavity. Otherwise, the patient could be injured.***

Usage Note

- ◆ ***Do not vibrate the scaler without connecting the handpiece and a tip and making sure the tip is tightened up properly. Otherwise, this could damage the circuit board or some other component. Also, it could cause some other instrument to operate in an erratic manner.***

Handpiece Light On/Off and Select Brightness for Light-equipped Models

For details, see page 36 “Turning handpiece lights on and off and selecting brightness”.

(19) Water Line Flushing System

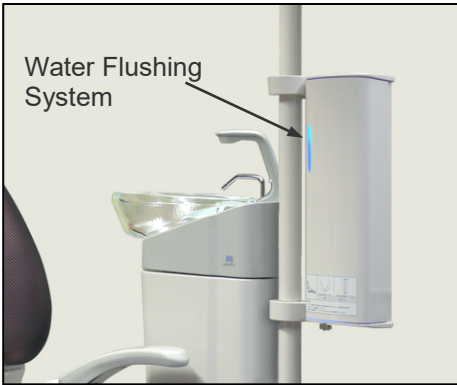

At the end of each day, flush out the water lines with a cleanser and leave the cleanser in the lines. Make this the last and final step of daily maintenance procedures.

Water Line Flushing Procedure

After Treatment (see page 69)

Clean water lines with cleanser.

1. Attach Flushing Device
2. Set Up for Flushing
3. Flush Water Lines
4. Leave Cleanser in Lines

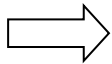
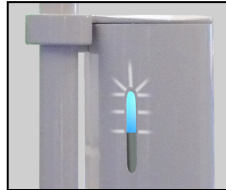

Before Treatment (see page 79)



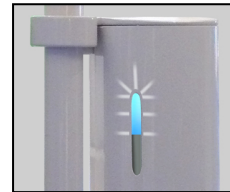









Flush out the cleanser with clean tap water.

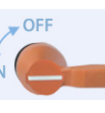

Check Before Using

Make sure the the cleanser has been flushed out. Also check the Flush Lamp; make sure it stays on and is not blinking.

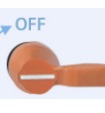

Flush Lamp	Ready for Use?	Blue Water Tube	Water Valve	Bottle Switch
Blinking (Leave cleanser in lines) 	No			
Blinking (Flash out cleanser) 	No			
Stays On Not Blinking 	Yes			

WARNING

- **Do not use the unit if the Flush Lamp is blinking. Make sure the cleanser has been flushed out and the Flush Lamp stays on without blinking before using the unit.**

After Treatment

1. Set Up Flushing Device

- (1) Turn the main switch on. Lower the seat all the way down and raise the backrest all the way up. Raise the doctor side arm rest (option). Raise the tray to its highest position. Pull out the vacuum syringe to see if it works and then turn the unit off.
- (2) Open the main water and air valves.
- (3) Line up the flushing device with the cup water outlet and attach it.

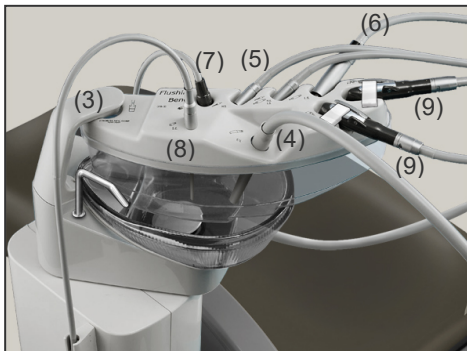
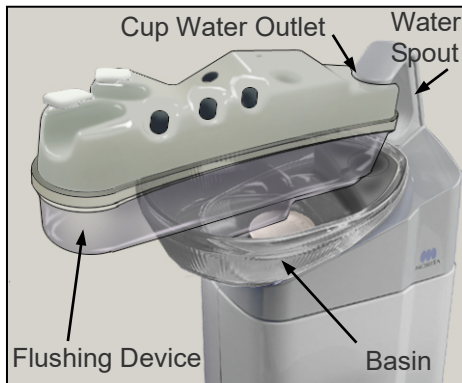

Usage Note

- ◆ *Do not bump or hit the water spout or the cup stand. This could result in leakage or a malfunction.*

- (4) Take the vacuum tip off the vacuum syringe and then put it in its place in the flushing device.
- (5) Take the air turbine handpieces off their tubes. Pull out the tubes and insert them into their places on the flushing device.
- (6) Take the attachment off the TORX micromotor. Pull out the motor and insert it into its place in the flushing device.
- (7) Take the scaler off its tube. Pull out the scaler tube and insert it into its place in the flushing device.
- (8) Take the tip out of the saliva ejector. Insert the ejector tube into its place in the flushing device.

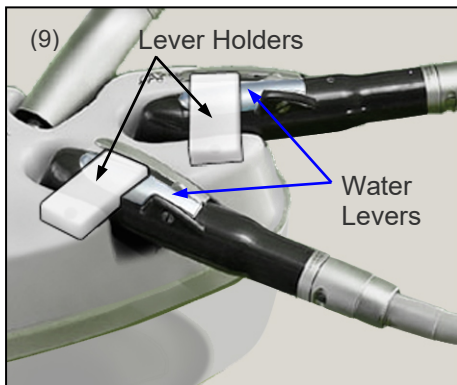

- (9) Take the nozzles out of the three-way syringes. Insert the syringes into their places in the flushing device. Use the lever holder to hold the water levers down.

CAUTION

- *Never press a chair positioning switch when instruments are in the flushing device. If the backrest moved, an instrument could come out and hit someone, causing an injury or damaging the instrument.*
- *If a handpiece or syringe tube does not reach the flushing device, go back to step 1 and repeat the set up procedure. Make sure the chair and tray positions are OK. For safety, the chair cannot move when all the instrument tubes are in the flushing device.*

Usage Note

- ◆ *Make sure the main switch is turned off before inserting the instruments into the Flushing Device. The Flushing Device could overflow if the three-way syringes are inserted with the main switch turned on.*
- ◆ *The Flushing Device will not work unless all the instruments are inserted.*
- ◆ *The main switch will turn off automatically if you don't do anything for 3 minutes. Turn it back on by pressing it twice.*
- ◆ *Make sure the Flushing Device is properly and securely connected to the cup water outlet.*

2. Set Up Cleanser

- (1) Make sure the main switch is turned off.
- (2) Open the cover of the Water Line Flushing System.

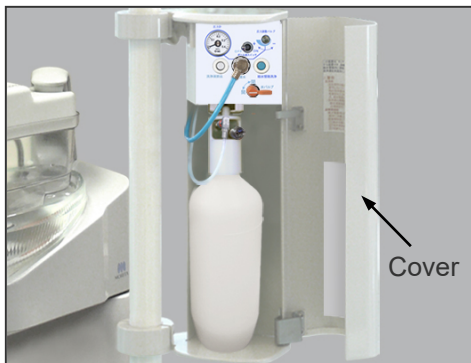

- (3) Check that the Bottle Switch is turned off and the pressure gauge reads 0 MPa.



- (4) Disconnect the white air tube on the top of the bottle.

- 1) Pull the ring back.
- 2) Take the tube off.

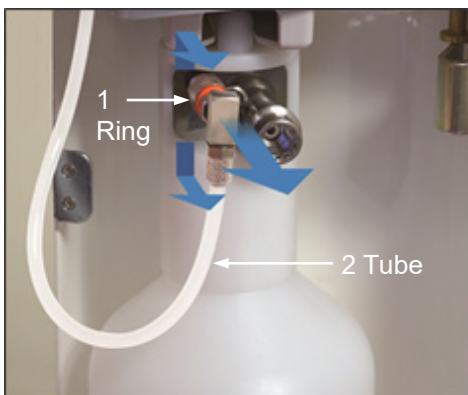

- (5) Pull out the bottle.



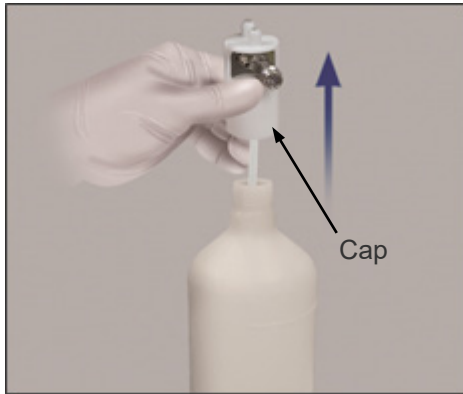

- (6) Take the cap off.
* Empty out any cleanser left in it.



- (7) Fill the bottle with 750 ml (up to the guide line on the bottle) of cleanser (hydrogen peroxide solution, 1,000 ppm concentration).
Refer to the user instructions for the hydrogen peroxide solution being used for details on handling and usage.

CAUTION

- *If any cleanser gets in your eyes, wash them with plenty of water and see a doctor.*
- *If the cleanser is accidentally ingested, drink plenty of water and see a doctor.*
- *If the cleanser gets on your skin or sensitive membranes, wash it off with plenty of water.*
- *Wear surgical gloves when handling the cleanser.*

WARNING

- *Do not use any cleanser except the one recommended by J. MORITA OFFICE. Any other cleanser or solution could harm the patient or damage the water lines.*
- *Do not fail to dilute the cleanser at the proper ratio.*

(8) Put the cap back on the bottle.

⚠ CAUTION

- *Make sure the cap is on tight. A malfunction could occur if it came off.*



(9) Line up the stud on the cap with the groove and push the bottle all the way back in. Reconnect the white air tube.

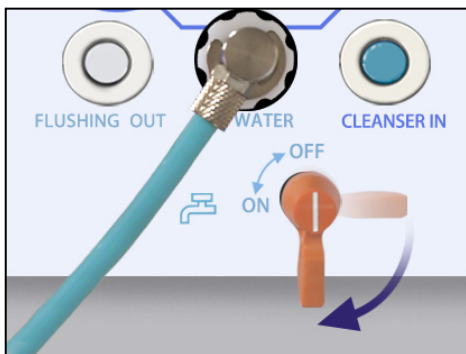

(10) Turn the Water Valve off.



(11) Loosen the lock nut, and then take the blue water tube off the bottle.

Usage Note

- ◆ *Make sure the water valve is closed before taking off the blue water tube. If the tube is taken off or put on while the valve is open, water will leak out from the lock nut.*



(12) Put the blue water tube on the main unit and fasten it with the lock nut.

Usage Note

- ◆ *Make sure the lock nut is tight enough. Otherwise, water (or cleaner) might not flow properly through the internal lines or water might leak out from the lock nut.*



Usage Note

- ◆ *If the blue water tube is hard to put on or take off, coat the O-ring on the lock nut with a little vaseline.*



(13) Connect the white air tube to its original position.

⚠ CAUTION

- *Make sure the air and water tubes are not bent or pinched when they are connected.*
- *Make sure the tubes are properly and securely connected.*

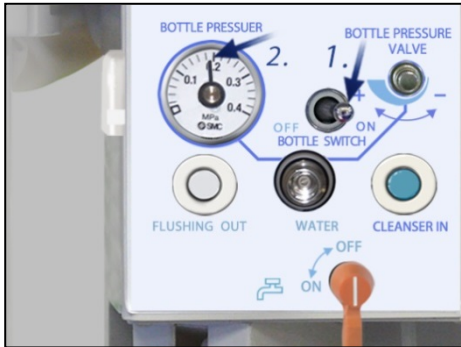

3. Flush with Cleanser

- (1) Make sure the main switch is turned off and then turn the bottle switch on.
- (2) Check that the pressure gauge reads 0.18 to 0.20 MPa.

If pressure is not between 0.18 to 0.20 MPa

Adjust the pressure regulator

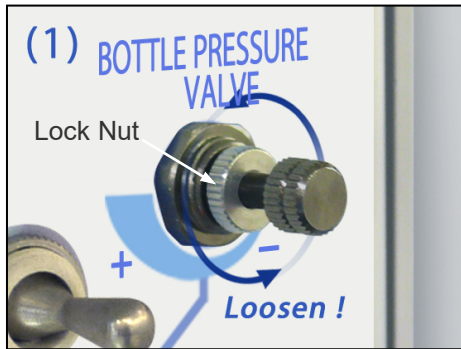

- 1) Loosen the lock nut on the pressure regulator.

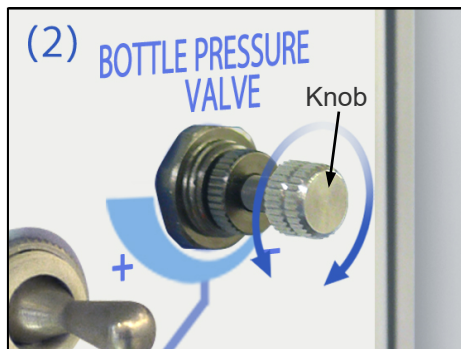

- 2) Turn the regulator's knob until the gauge reads 0.18 to 0.20 MPa.



- 3) After adjusting the pressure, tighten up the lock nut.

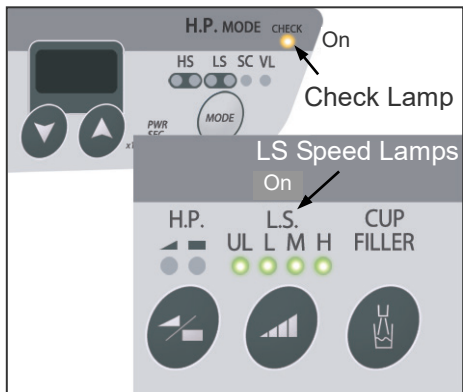

- (3) Turn the main switch on.
- (4) Check that the Check Lamp is on, and that the 4 speed lamps for the LS handpiece are on. Then press the Cleanser Flush button to start the procedure. Check that the Flush Lamp is blinking.

⚠ CAUTION

- *Do not press a positioning switch after the power is turned on; the chair might start to move if a positioning switch is pressed before the Check Lamp and LS Speed lamps light up.*

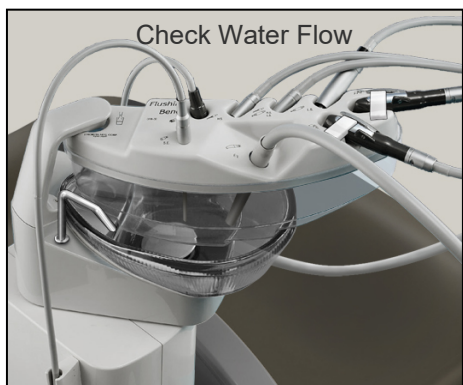

- (5) Check that water is flowing through the water spout and the various main tubes. Also check that the volume of cleanser in the bottle is going down.

The Check Lamp and LS Speed lamps blink to show the progress of the procedure as indicated below.
(This take approximates 1 minute and 40 seconds.)

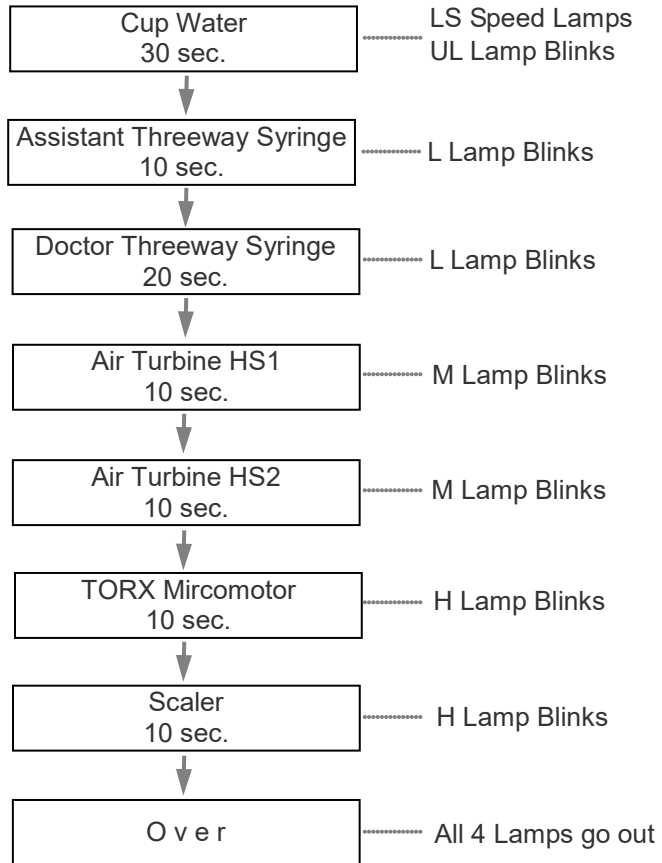
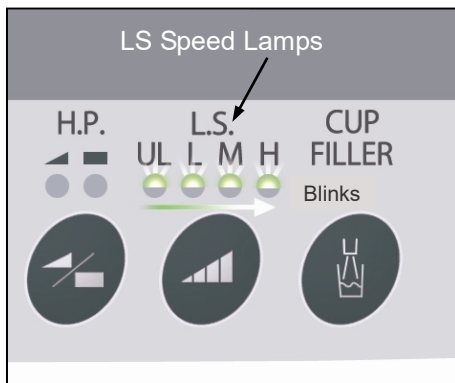
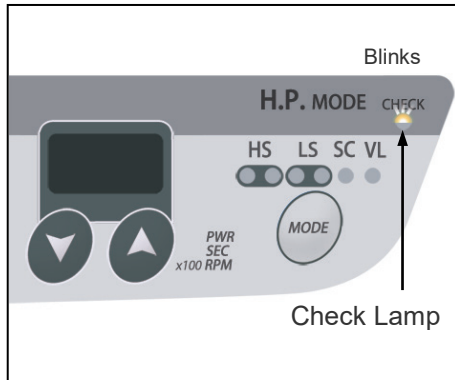

How to Stop Procedure

Press the Cleanser Flush Switch to stop the procedure; press it again to restart the procedure.

Usage Note

- ◆ *If, after stopping the procedure, water collects in the flushing device, put the vacuum syringe away and then take it out again to suck up the excess water.*

- (6) When the flushing procedure is completed, the Check Lamp will go out and the main switch lamp will start to blink.

If, for some reason, the procedure does not follow the prescribed order as outlined above, or if the Flush Lamp is out, go back to “1. Set Up Cleanser” and start over.

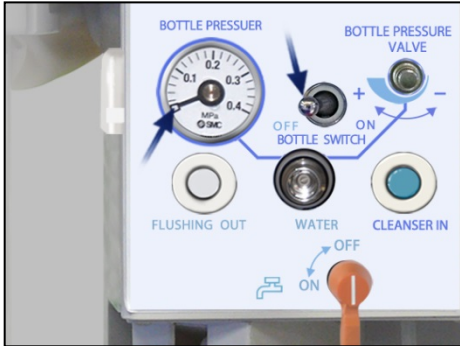

4. Leave Cleanser in Water Lines

- (1) Turn the bottle switch off after the flushing has been completed.
Check that the pressure gauge reads 0 MPa.

⚠ CAUTION

- *If the pressure gauge does not go down to 0, contact your local dealer or J. MORITA OFFICE. The air tube could fly off with considerable force if it is disconnected.*

- (2) Empty out the bottle.

Usage Note

- ◆ *Do not fail to empty out any cleaning liquid left in the bottle at the water lines have been flushed out. Otherwise, the cleaning fluid could cause mold to grow or pollute the water lines.*

- (3) Turn the main switch off.
- (4) Close the main air and water valves.

- * Leave the cleanser in the water lines until the next time you use the equipment.

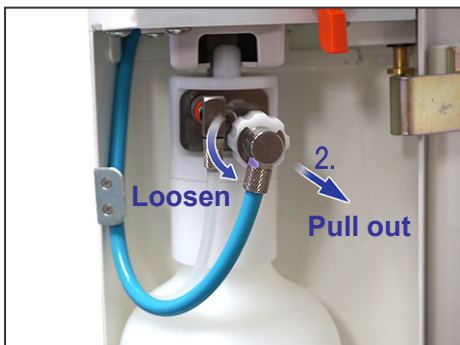
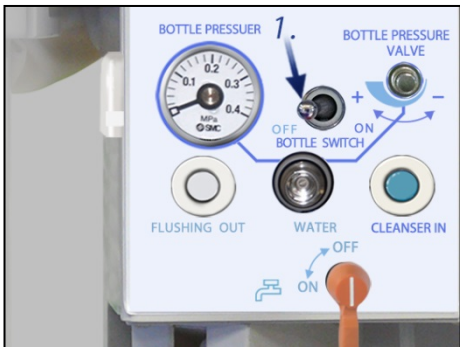

Before Treatment

1. Flush out the cleanser with water

* This takes 5 to 7 minutes.

⚠ WARNING

- *Never use the equipment with the cleanser left in the water lines.*

If the instrument tubes have been put away, put them back in the flushing device.

See page 69 for how to set up the flushing device: Set Up Flushing Device.

(1) Open the cover of the Water Line Flushing System and turn off the Bottle Switch.

(2) Take the blue water tube off the bottle and connect it to the flushing operation panel.

(3) Plug the disconnected water tube into the connector on operation panel labeled Tap Water.

⚠ CAUTION

- *Make sure the tube is properly and securely connected.*

Usage Note

- ◆ *If the blue water tube is hard to put on or take off, coat the O-ring on the lock nut with a little vaseline.*

- (4) Turn the main switch on. Take out the vacuum syringe and check that it works; then turn off the main switch.

Usage Note

- ◆ *Make sure the main switch is turned off before setting up the flushing device. Otherwise, water from the threeway syringes could fill the device up and overflow.*
- ◆ *The flushing system will not work until all the instruments are set properly in place.*
- ◆ *The main switch will turn itself off if you don't do anything for 3 minutes. Press it twice to turn it back on.*
- ◆ *Make sure the device is correctly lined up with the outlet on the cup filler water spout.*



- (5) Open the main water and air valves.
- (6) Turn on the flushing Water Valve.
- (7) Check that the Flush Lamp is blinking, that the Check Lamp on the assistant's side is on, and that the speed lamp for the LS handpiece are on. Then press the Water Flush button to start the procedure.

⚠ CAUTION

- *Do not press a positioning switch after the power is turned on; the chair might start to move if a positioning switch is pressed before the Check Lamp and LS Speed lamps light up.*

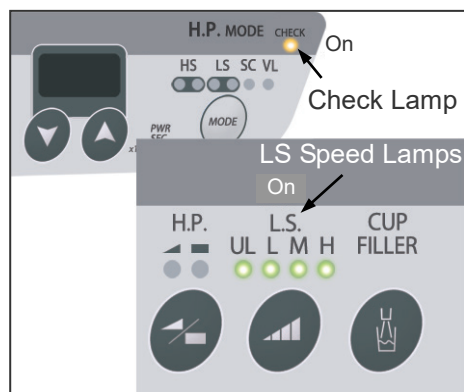

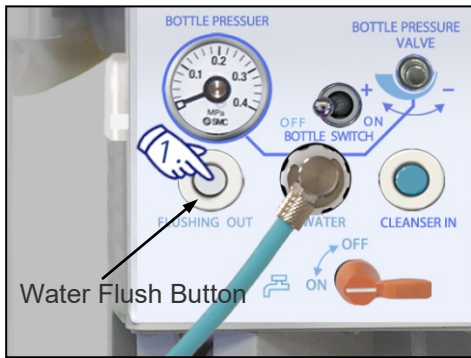

- * When all the tubes are pulled out and the main switch is turned on, the Check Lamp and the 4 LS Speed lamps light up to show that the unit is ready for water flushing. At this time, all normal operations such as chair positioning are disabled.
- * If the vacuum stops working during flushing or if it is not turned on when it is put into the flushing device, the main switch will automatically turn off and the flushing procedure will stop.

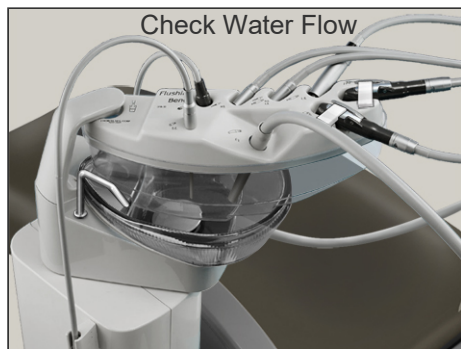

(8) Check that water is flowing through the water spout and the various main tubes.

Usage Note

- ◆ If the water flow is not sufficient, increase it with the spray adjustment knobs.
- ◆ If the vacuum is not turned on and running, water will over flow from the flushing device.

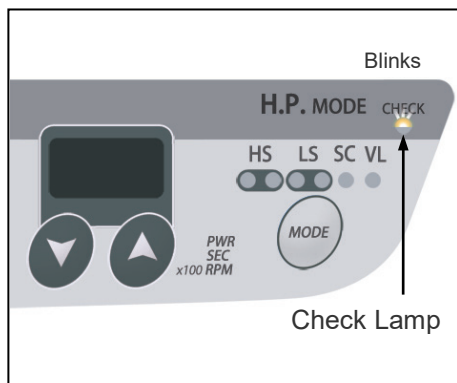

The Check Lamp and LS Speed lamps blink to show the progress of the procedure as indicated below.

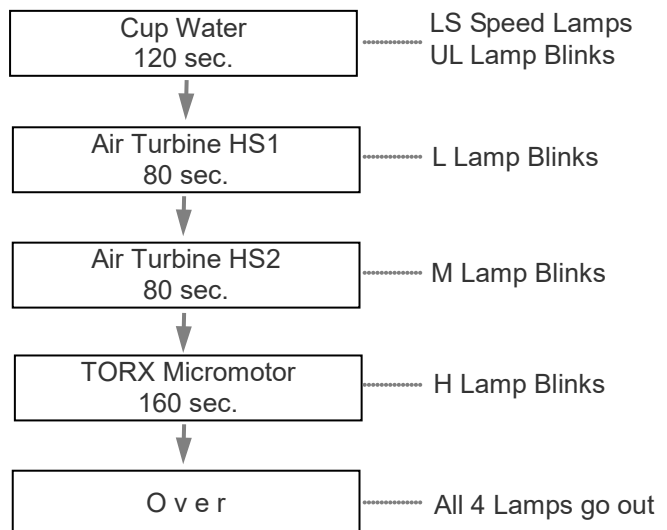
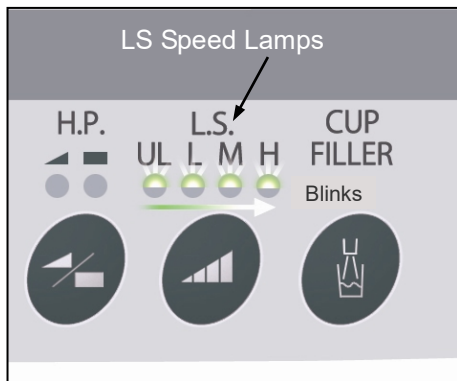

- * Flushing for the threeway syringes starts simultaneously with the cup water flushing and that for the scaler starts with the HS1, and these continue until the procedure is finished.

How to Stop Procedure

Press the Water Flush button to stop the procedure; press it again to restart the procedure.

Usage Note

- ◆ *If, after stopping the procedure, water collects in the flushing device, put the vacuum syringe away and then take it out again to suck up the excess water.*

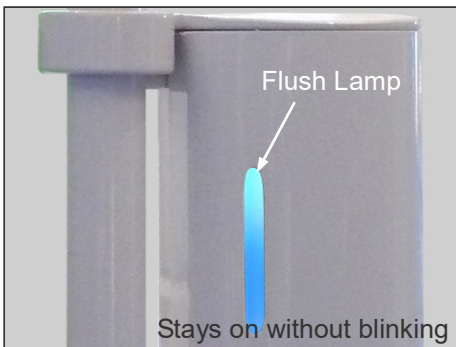

- (9) When the flushing procedure is completed, the Check Lamp will go out and the main switch lamp will start to blink. If, for some reason, the procedure is not properly completed or if the Flush Lamp goes out, start over from the beginning and repeat the procedure. Turn the main switch off.

- (10) Take the syringes and tubes out in the reverse order used to insert them. Take the flushing device off the basin.

Usage Note

- ◆ *Do not press the Vacuum or the SE switch during water flushing.*
- ◆ *If you do not turn the main power after flushing is completed, the saliva ejector will stay on.*

- * The chair cannot be operated during flushing.
- * Before use, put the nozzles on the threeway syringes and an attachment on the micromotor and blow air through them to force out any water in the lines.

WARNING

- *Never use the unit if cleanser is still in the water lines.*
- *Check the following three things before beginning treatment:*
 1. *Make sure the blue water tube for the flushing system is connected to the water connector on flushing system control panel.*
 2. *Make sure the water lines have been flushed out with regular tap water.*
 3. *Make sure the Flush Lamp stays on constantly and is not blinking.*

3. After Use

(1) Turn Main Switch Off

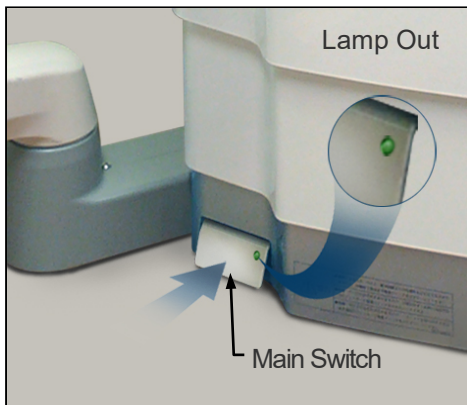

Press the main switch
The main lamp goes out when the chair is turned off.

! WARNING

- *After use, be sure to turn off the Main switch. Otherwise, it could result in fires or burns due to overheating as well as water leakage from the supply line.*

(2) Close main water and air valves

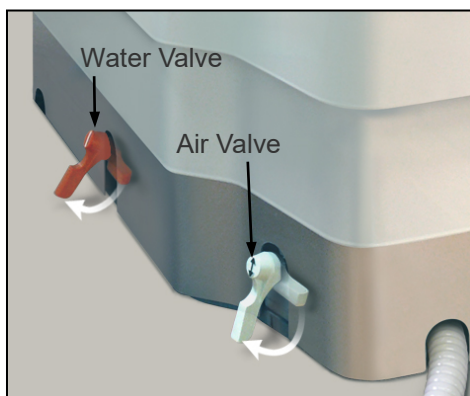

Push the valve levers down to close them.

! WARNING

- *After use, be sure to close the main water valve. Otherwise, it could result in water leakage.*

* Do not fail to turn off the main switch and close the main air and water valves after each day's use.

Usage Note

- ◆ *In very cold weather the water in the lines could freeze and burst.
Prevent this in the following way:*
 1. *Close the main water valve*
 2. *Run water through the threeway syringe*
 3. *Run water through the air turbine handpieces, the TORX micromotor and the scaler*
 4. *Turn the main switch off*
 5. *Close the air valve*

Sterilization, Parts Replacement and Storage

1. Sterilization

(1) Autoclavable Components and Instruments

Recommended: +135°C (+275°F) for at least 5 minutes inside a sterilization pouch.

Minimum drying time after sterilization: 10 minutes.

- ◆ Air Turbine Handpieces (refer to separate operation manual)
- ◆ TORX Micromotor Attachments (refer to separate operation manual)
- ◆ Micromotor Motor Cover (refer to separate operation manual)
- ◆ Air Torx
- ◆ Threeway Syringe (nozzle and case) (refer to separate operation manual)
- ◆ Vacuum Syringe (syringe body, vacuum tip and rubber tip)
- ◆ Saliva Ejector (ejector tip)
- ◆ Scaler Handpiece and Tips

WARNING

- *To prevent the spread of serious, life-threatening infections such as HIV and hepatitis B, air turbine handpieces, TORX micromotor attachments, the micromotor motor cover, the Air Torx, the cases and nozzles for threeway syringes, the body, tip and rubber tip for the vacuum syringe, and the tip for the saliva ejector must be autoclaved after the completing treatment for each patient.*

CAUTION

- *Take the nozzle out of the threeway syringe case and autoclave it. If the light is an LED type, put the cap on the lamp cover.*
- *Take the tip out of the saliva ejector and autoclave it.*

- ◆ Tray Sheet
- ◆ Waste Cup Holder
- ◆ Medicinal Vial Holder
- ◆ Handpiece Holders
- ◆ Tray Handle
- ◆ Handpiece Guard
- ◆ Light Handle Covers (refer to separate operation manual)

CAUTION

- *Instruments are extremely hot after autoclaving; do not touch until they cool off.*

Usage Note

- ◆ *Do not sterilize in any way except autoclave.*
- ◆ *Autoclave and drying temperatures must not exceed +135°C (+275°F).*
- ◆ *Clean all instruments thoroughly before autoclaving them. Chemicals and foreign matter could damage the instruments or cause discoloration.*
- ◆ *Oils and chemicals can deform or discolor plastics and resins during autoclaving; instruments and utensils which are used with chemicals or oils should be autoclaved separately from others. Plastic items can also be deformed by the heat; avoid this by putting them on a piece of gauze and take care that they do not directly contact the tray or other metals parts of the autoclave.*

(2) Components Disinfected by Wiping with Ethanol for Disinfection (Ethanol 70 vol% to 80 vol%)

- ◆ Headrest, Seat, Backrest, Leg Support
- ◆ Headrest Cover
- ◆ Main Tubes
- ◆ PdW Tray
- ◆ Front Cover for Operating Light (refer to separate user's manual)
- ◆ Shoulder and Tray Switch Panels
- ◆ Housing and Enamel Surfaces
- ◆ Bottle for Water Line Flushing System

! WARNING

- ***Be sure to turn off the main switch before disinfecting components and surfaces with Ethanol for Disinfection (Ethanol 70 vol% to 80 vol%). Otherwise, there is a risk of electric shock, burns, or the accidental pressing of a switch which could cause the chair to move and result in an accident.***

Usage Note

- ◆ *Alkaline and acid cleaning solutions, liquid cresol soap, and other chemicals could damage or discolor the chair's finish, seat etc. Do not clean the finish, seat etc. with anything except Ethanol for Disinfection (Ethanol 70 vol% to 80 vol%) or a neutral detergent. Be especially careful not to use aldehydes, cresols, hypochlorite, triclosan, and quaternary ammonium salts. (Check contents charts and cautionary notes on containers.)*
- ◆ *If any chemicals get on the finish, seat etc., wipe them off immediately with Ethanol for Disinfection (Ethanol 70 vol% to 80 vol%).*
- ◆ *Do not use ozone water to clean the unit or its drain and vacuum lines. Ozone water could cause rusting inside the lines and other damage to the unit.*
- ◆ *Do not disinfect the clinic with ozone gas or ultraviolet light. This could damage plastic and rubber components.*
- ◆ *When cleaning the floor around the chair, take care not to get water or solutions used for floor waxing on the foot control or the safety switch mat for FT units.*

2. Regular Maintenance

* Perform maintenance at the specified intervals or more frequently if necessary.

(1) Daily Before Use

Before Treatment

Flush the cleanser out of the water lines.
See page 79 for instructions.

(2) Between Patients

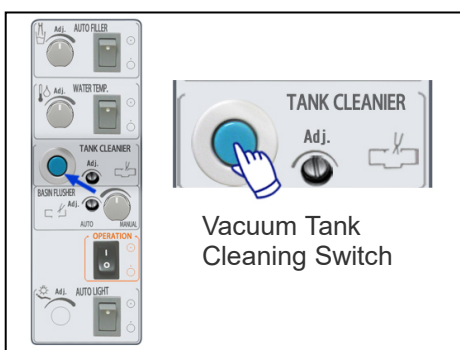
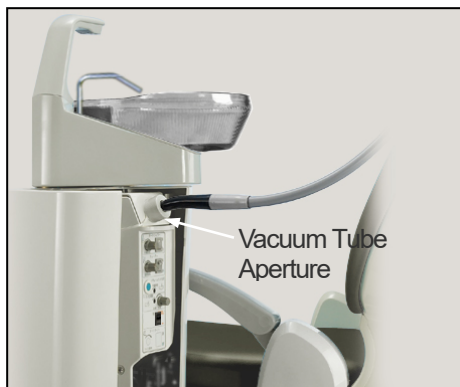
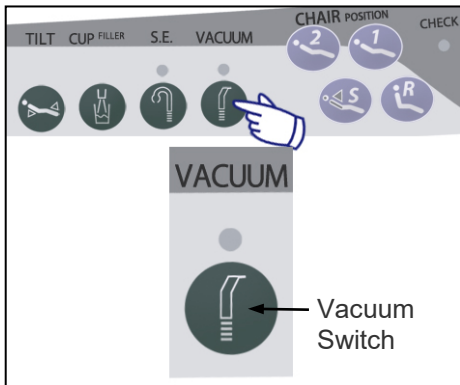
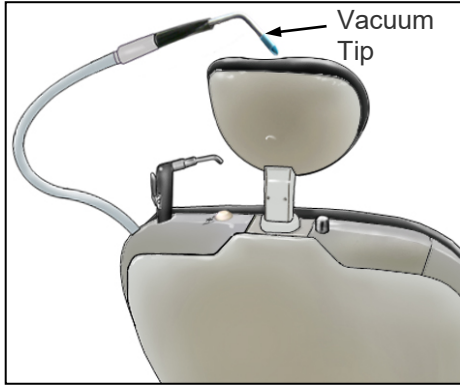

Vacuum System Auto Cleaning

The vacuum system must be cleaned regularly to prevent the vacuum from losing power.

- 1) Take the vacuum tip out of the syringe.
- 2) Take out the syringe and press the vacuum switch to turn off the suction
- 3) Raise the backrest all the way up.
- 4) Open the maintenance cover and take the cap off the aperture for the vacuum tube. Insert the vacuum tube into the aperture.
- 5) Press the Cleaning Switch. The vacuum tube system will be cleaned first and then the inside of the vacuum tank.
- 6) After cleaning, put the vacuum syringe back in its holder, replace the cap on the vacuum tube cleaning aperture, and close the maintenance cover.

⚠ CAUTION

- *Never press a chair operation switch while the vacuum syringe is inserted in its cleaning aperture; if the backrest tilted, the syringe could come out and strike some one or damage something.*
- *If the vacuum syringe is hard to insert, coat the O-ring inside the aperture with a little vaseline.*

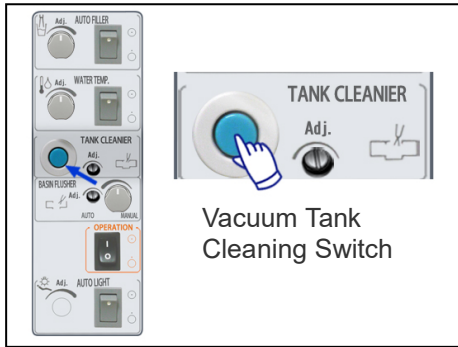

Vacuum Tank only Auto Cleaning (option)

Press the Vacuum Tank Cleaning Switch to automatically clean the vacuum tank.

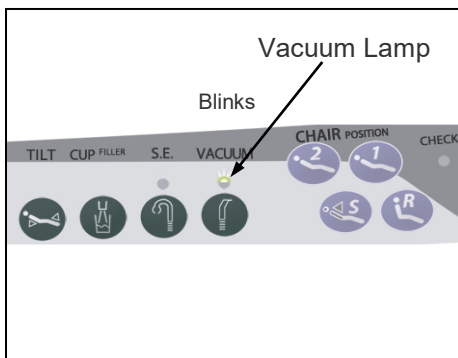

- * The vacuum lamp flashes on and off during the cleaning process; do not turn off the main switch until this lamp goes off.

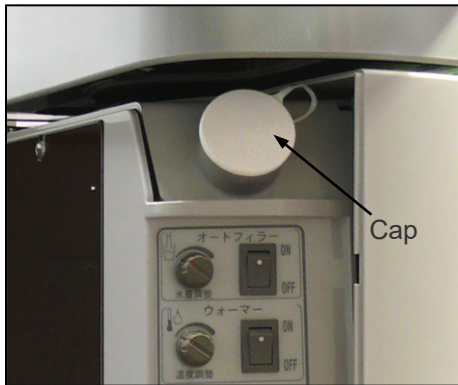

Usage Note

- ◆ Do not fail to put the cap on the vacuum tube aperture when cleaning the vacuum tank.

Vacuum Tank only Auto Cleaning (option)

Open the maintenance cover and then use a screwdriver to turn the water screw in the direction shown by the arrow in the illustration to increase the amount of water.



(3) Everyday After Use

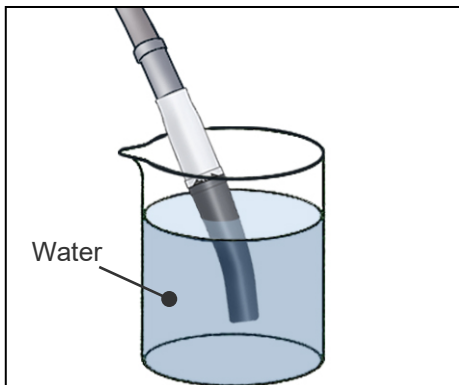
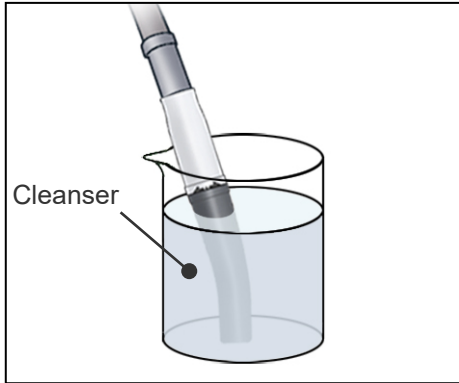

Clean Vacuum Lines

Suck up some of the special cleanser provided. Wait 5 minutes and then suck up at least 300 ml of water.

Usage Note

- ◆ *Read the instructions for how to use the cleaning solution provided. Suck up at least 300 ml of water after using the cleaning solution.*

Clean Vacuum Lines

- * Wear surgical gloves when doing this.
 - Clean the vacuum filter whenever the vacuum seems to have lost power or whenever it has sucked in an inlay or other object.
- 1) Press the vacuum switch on the assistant side shoulder to remove all the water left in the filter. Wait 5 seconds and then press the switch again to turn the vacuum off. Finally turn off the main switch.

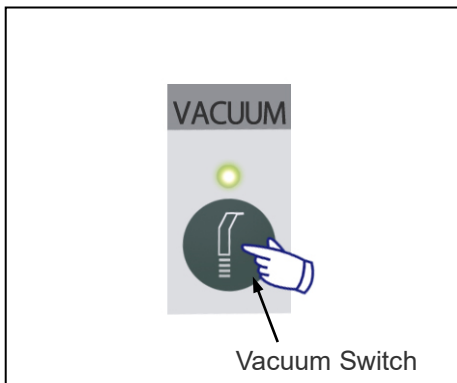

! WARNING

- *Be sure to turn off the main switch. This will eliminate the risk of burns and electric shocks.*



- 2) Open the maintenance cover and pull off the filter cover.

Usage Note

- ◆ *Be careful that contaminated matter or other foreign debris does not fall out of the filter when you pull it out.*
- ◆ *Have a bucket or some other container ready to catch any contaminated water that drips from the filter.*

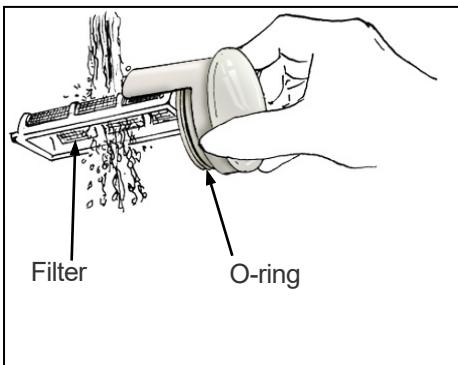

- 3) Wash the filter in running water.

Usage Note

- ◆ *Coat the O-ring with Vaseline or some similar substance before putting the filter back.*



- 4) Push the filter all the way back into its original position.

Usage Note

- ◆ *The vacuum will lose power or leak if the filter cover is not fit in as tightly as possible.*

Flush Water Lines

Flush out the water lines every day after useClean Vacuum Lines

- 1) Get Cleanser Ready
- 2) Attach Flushing Device
- 3) Flush Water Lines
- 4) Leave Cleanser in Water Lines
For details, see page 69 “After Treatment”.

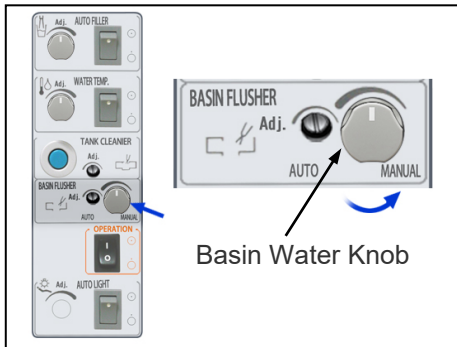

Basin

- * Wear surgical gloves when doing this.

Open the maintenance cover and turn on the basin rinsing knob to rinse out the basin. If chemicals or other debris are not removed satisfactorily, wash it out with a neutral detergent.

Usage Note

- ◆ *Immediately rinse away chemicals like Saforide.*



Basin Filter and Catch

- * Wear surgical gloves when doing this.

- 1) Take out the filter and catch.
- 2) Wash them in running water.
- 3) Put them back in their original positions.

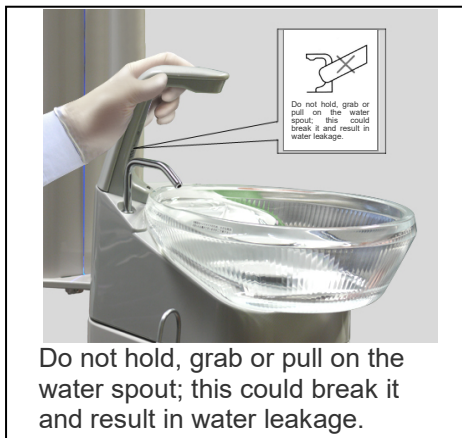

Usage Note

- ◆ *Do not hold onto the water spout or apply force to it as this could cause it to start leaking.*
- ◆ *Do not get water or solvents used for waxing on the cover for the foot control or the safety switch mat when cleaning the floor around the unit.*

(4) Once a Week

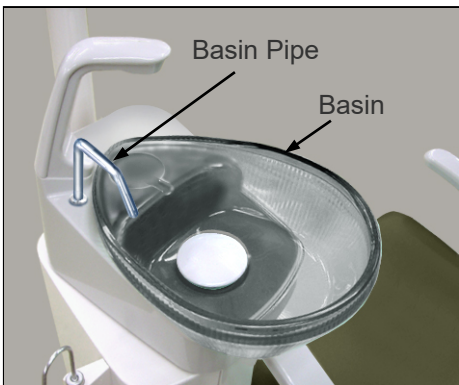
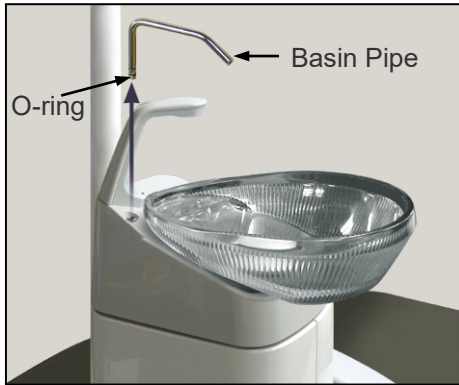

Clean Basin and Basin Pipe

! WARNING

- ***Be sure to turn off the main switch before doing this. If the switch is on when the pipe is removed, water could splash down inside the basin pole and get on electrical components.***

* Wear surgical gloves when doing this.

- 1) Lower the chair as far as it will go and then turn off the main switch. Remove the basin pipe. Grip the basin with both hands as shown in the photo and take the basin out.

Usage Note

- ◆ ***Make sure the holder for the basin does not come up along with the basin. Press down on the holder when removing the basin. If the basin is hard to remove, carefully wiggle it around to pull it out.***

- 2) Wash the basin and its pipe in running water.
- 3) Put the basin and its pipe all the way back into their original positions. (The pipe should be pointing down at the inside of the bowl.)

Usage Note

- ◆ ***Make sure that the basin pipe is not plugged up and is all the way in and that its O-ring is intact and undamaged. Otherwise, the water pressure could push the pipe out.***
- ◆ ***Make sure there is no leakage from the pipe joint.***
- ◆ ***Do not use rough scrub brushes etc. that could scratch the surface.***

Usage Note

- ◆ *The basin is made of glass and must be handled very carefully. (Bumping, dropping or even excessive squeezing could crack it.)*
- ◆ *Make sure there is no leakage from the basin. If the basin is chipped, cracked or wobbly, contact your local dealer or J. MORITA OFFICE.*
- ◆ *If the O-rings for the basin or the basin pipe seem stiff (hard to put on and take off), coat them with a little vaseline or replace them.*
- ◆ *Check to see if the O-rings are broken or damaged. If one is, contact your local dealer or J. MORITA OFFICE.*
- ◆ *The basin cannot be autoclaved.*
- ◆ *Immediately wipe off any chemicals like Saforide that get on the bowl.*

CAUTION

- *Internal water pressure is set at 0.2 MPa. If the pressure goes over 0.39 Mpa, a release valve opens and water will start coming out of the basin water spout. If this happens, there could be a problem with the water regulator valve or some other malfunction. In this case, contact your local dealer or J. MORITA OFFICE.*

(5) Once a Month

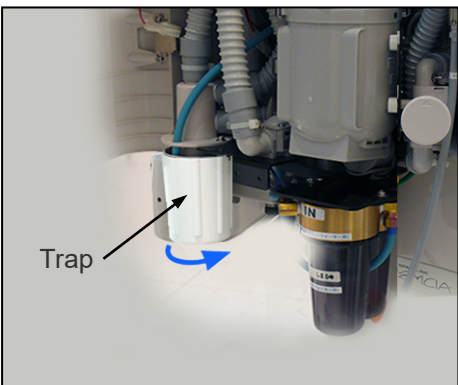
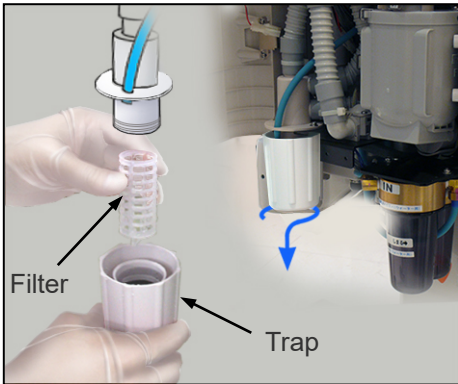

Filter in the Basin Drain Trap

! WARNING

- ***Be sure to turn off the main switch before doing this. Otherwise, there is a risk of electric shock and burns.***

* Wear surgical gloves when doing this.

1) Turn the main switch off. Take the trap off by turning it in the direction indicated by the arrow in the illustration.

2) Wash the trap and filter in running water.

3) Replace the filter and the trap; tighten the trap up by turning it in the direction indicated by the arrow.

! CAUTION

- ***Turn the main switch on and run some water through the unit to make sure the trap does not leak.***

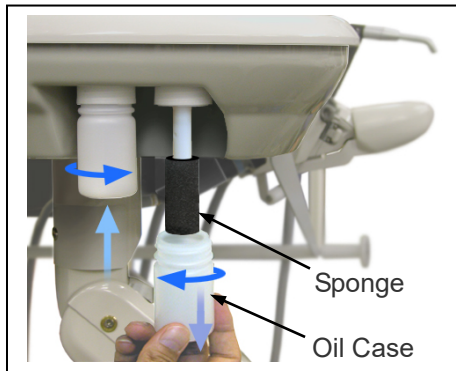

Empty Oil Collection Case for Air Turbine System

The oil case for the air turbine system is underneath the tray. Empty it. Take off the sponge and wash both it and the case in running water.

Squeeze all the water out of the sponge and reattach it.

Screw the case all the way back on.

Usage Note

- ◆ *If the turbine has a broken O-ring or if its spray is not working properly, a lot of oil might collect inside the case rather quickly.*

(6) Once Every Six Months

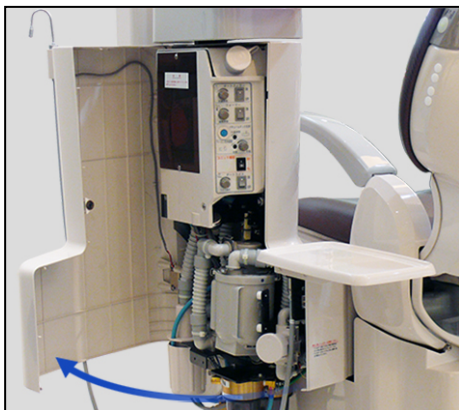

Vacuum Tank

(Units connected to a central vacuum system do not have a tank.)

* Wear surgical gloves when doing this.

- (1) Raise the seat all the way up.
Turn off the main switch.
Open the maintenance cover.

! WARNING

- *Be sure to turn off the main switch before doing this. Otherwise, there is a risk of electric shock and burns.*

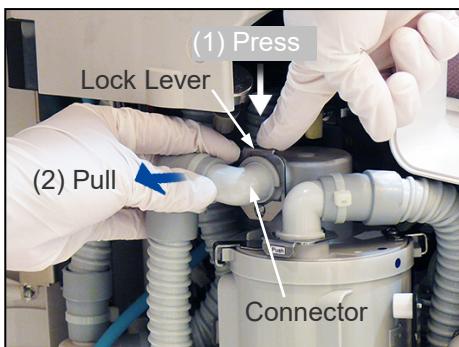

- (2) Disconnect the two tubes.
 - 1) Hold down the lock lever.
 - 2) Pull off the connector.

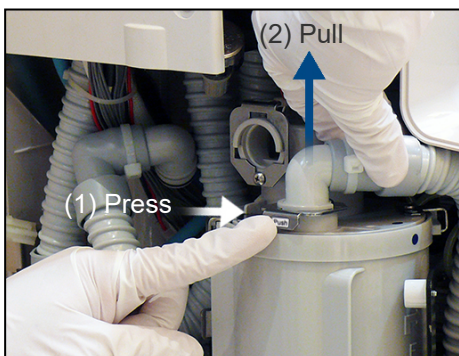

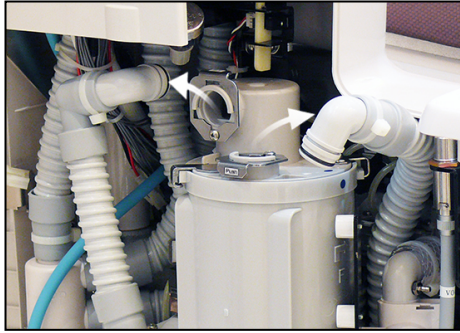

- (3) Position the connectors away from the tank as shown in the photo to make it easier to remove the tank.

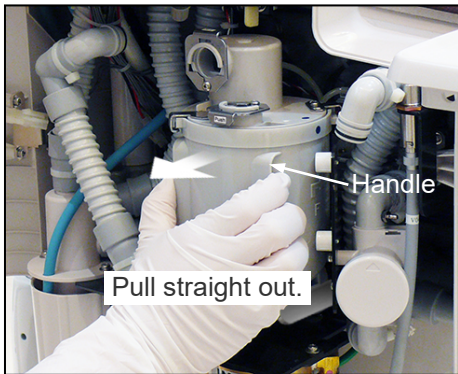

- (4) Grip the handle to pull out the vacuum tank.

Usage Note

- ◆ *Use both hands to make sure the tank does not fall down.*
- ◆ *Have a bucket or some other container ready to catch any contaminated water that drips out of the tank.*

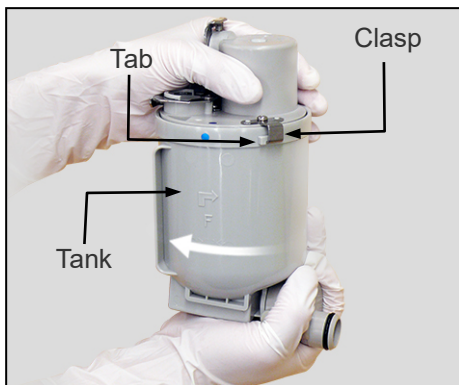

- (5) Turn the tank in the direction shown in the photo until the tab comes out of its metal clasp. Then pull the tank off its holder.



(6) Wash the tank out with running water.

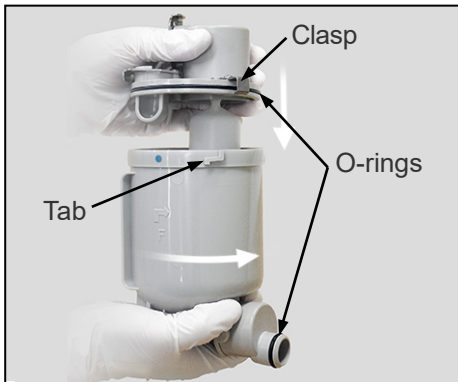

(7) Coat the O-ring on the tank holder with vaseline.

(8) Line up the tank and its holder as shown in the photo, and put it straight on. Then turn the tank until the tab is held by its clasp (until the blue dots line up).



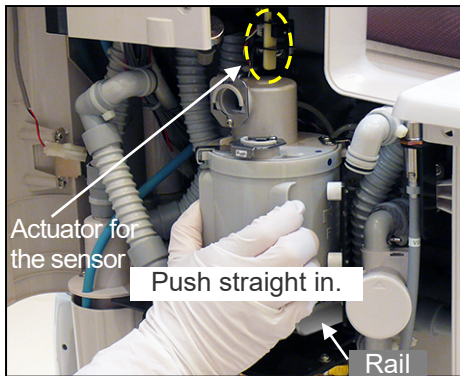

- (9) Set the guide on the bottom of the tank on the rail and push it into place. (Do not bump the actuator for the sensor.)

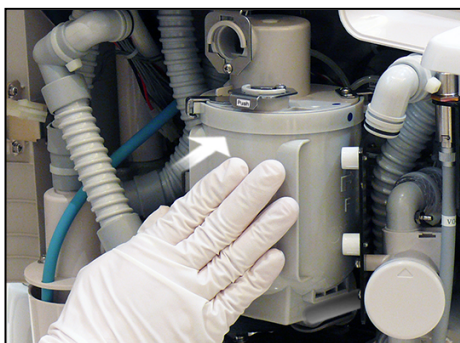

- (10) Press the tank firmly to secure it in place.

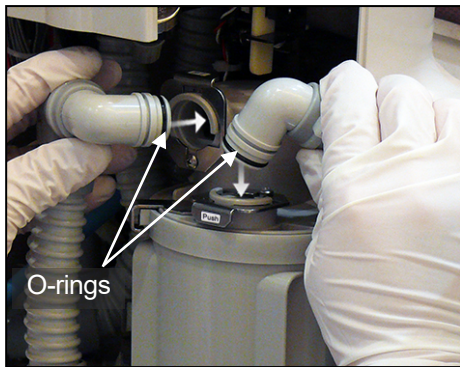

- (11) Coat the connector O-rings with Vaseline reconnect them. Push them on until they click into place and make sure they will not come off.

⚠ CAUTION

- *Water will leak if the tank drain tube is not properly installed.*

Usage Note

- ◆ *The vacuum will lose power if these connectors are not properly connected.*
- ◆ *Make sure O-rings are not broken or damaged.*

(7) Once a Year

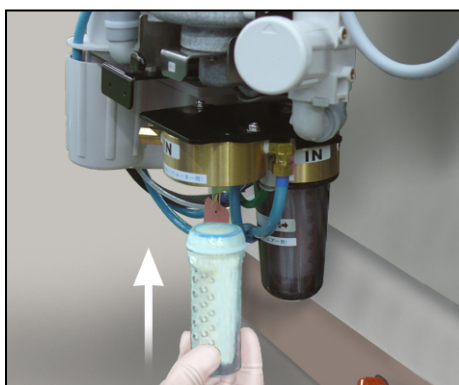
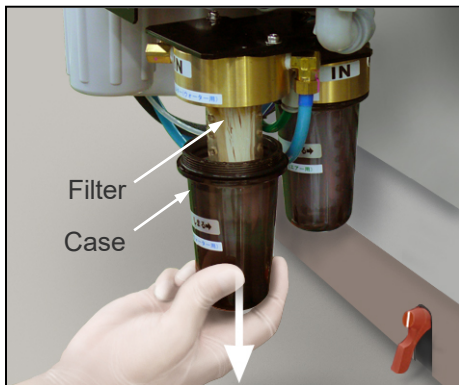
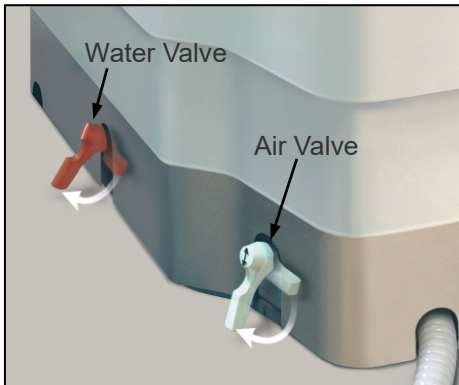

Bacteria Filters and Cases

(Do this whenever the air or water pressure to the threeway syringe or the handpieces seems weak.)

! WARNING

- ***Be sure to turn off the main switch before doing this. Otherwise, there is a risk of electric shock and burns.***

- (1) Turn the main switch off and close the air valve to the bacteria filter.
- (2) Operate the threeway syringe to remove internal pressure from the air and water systems. Remove the filter cases and the old air and water filters.
 - * Some water might spill out of the case for the water filter. Have a bucket or some other container ready to catch the water.

! WARNING

- ***It takes considerable force to take off the case if it is pressurized and so it is dangerous to do so. Always release the internal pressure before taking the case off.***

- (3) Fit new air and water filters onto the body and then put on new cases securely.

! CAUTION

- ***Make sure the filters are all the way on and securely installed. Tighten the filter case up securely. Otherwise water or air might leak.***
- ***Replace the cases as well as the filters. Old cases might be damaged and leaky.***

Usage Note

- ◆ ***Do not mix up the air and water bacteria filters. Put the filters on as shown in the illustration. Never touch the filters with your bare hands.***

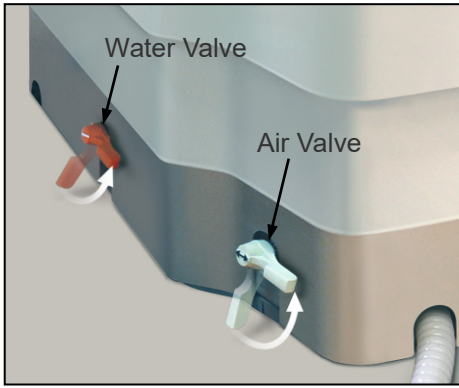

- (4) Open the main water and air valves. Make sure there is no air leakage.

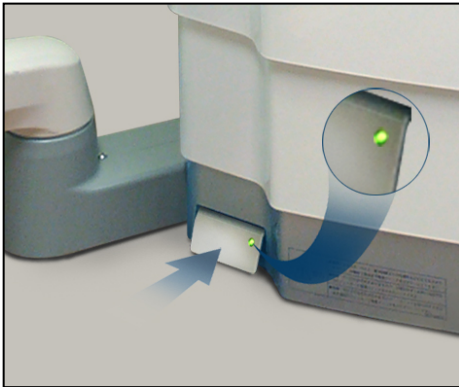

- (5) Turn the main switch on.
- (6) Open the manual basin rinsing knob and spray water from the threeway syringe to force the air out of the filter case.
- (7) Make sure no water is leaking from the water filter.
- * The manual basin rinsing knob valve may be closed again after doing this.

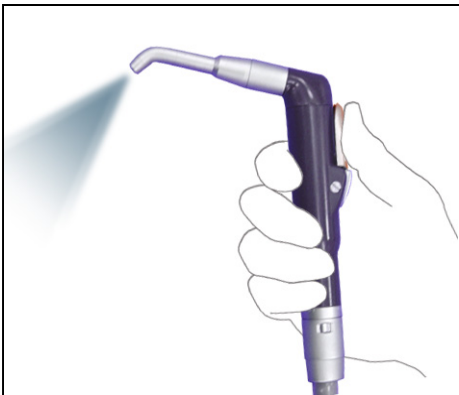

- (8) Make sure air and water come out of the threeway syringe.

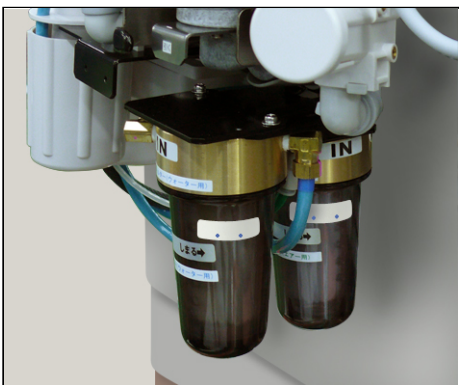

- (9) Write the installation date of the filters on the labels provided and stick them on the filter cases.

3. Replacement Parts

- * Replace the parts as necessary depending on degree of wear and length of use.
- * Order replacement parts from your local dealer or J. MORITA OFFICE.

(1) LED Lamp Replacement for Air Turbine Handpieces (with light) (option)

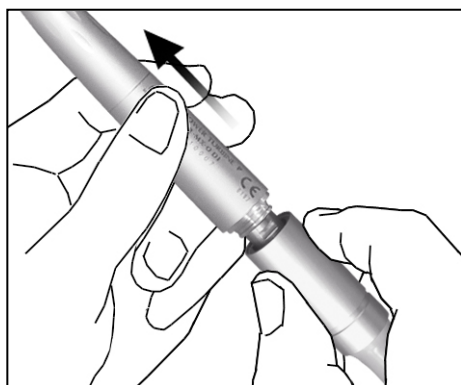

! WARNING

- *Be sure to turn off the main switch before doing this. Otherwise, there is a risk of electric shock and burns.*

! CAUTION

- *The lamp cover is extremely hot right after the LED burns out or is turned off and could burn you. Wait for it to cool off before touching it.*

(1) Take the handpiece off its tube.

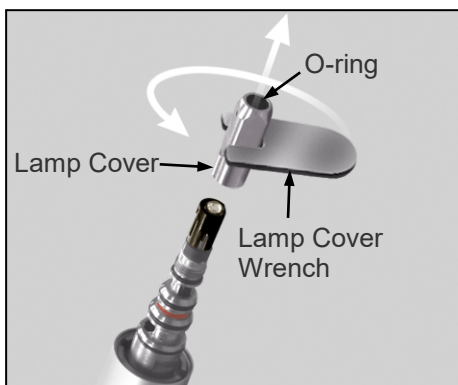

(2) Make sure the lamp has cooled off. Use the square hole on the cap tool to take the lamp cover off.

! CAUTION

- *Do not lose the O-ring inside the cover.*

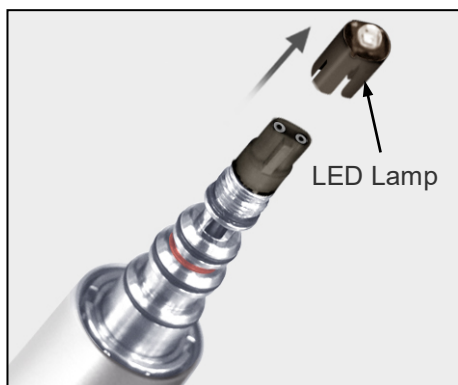

(3) Take the old LED lamp out of its socket.

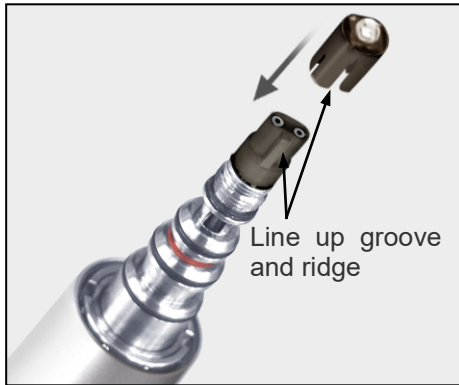

- (4) Line up the groove in the lamp with the ridge on the socket and push the lamp straight in all the way.



- (5) Screw the lamp cover on with your fingers and then tighten it up with the cover wrench.

CAUTION

- *If the O-ring inside the lamp cover is missing or damaged, the light may lack brightness or malfunction.*



- (6) Reconnect the handpiece, step on the foot pedal and see if the light works properly.

WARNING

- *Make sure the lamp cover is properly tightened up. Otherwise, the handpiece connection might not be secure and air pressure could force it off its main tube. This could result in an injury.*
- *Never let the light strike anyone directly in the eye. This could result in impaired vision.*

(2) O-ring Replacement for Air Turbine Handpieces

Replace the O-rings if air or water leaks from the tube joint.

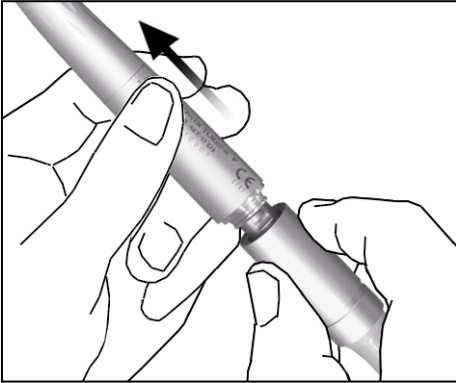

! WARNING

- *Be sure to turn off the main switch before doing this. Otherwise, there is a risk of electric shock and burns.*

! CAUTION

- *The lamp cover is extremely hot right after the LED burns out or is turned off and could burn you. Wait for it to cool off before touching it.*

(1) Take the handpiece off its tube.

(2) Replace all the O-rings at the same time.
After replacement, apply a little AR Spray to the new O-rings.

! WARNING

- *Do not fail to completely remove the old O-rings. Otherwise, air pressure could force the handpiece off the tube and cause an injury.*

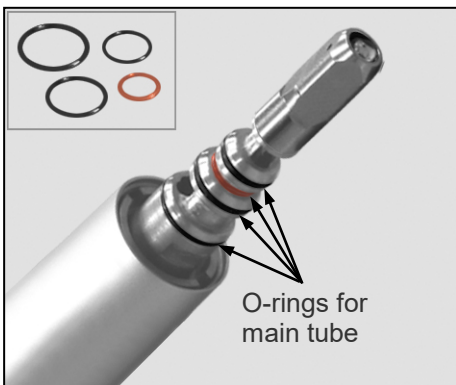

Usage Note

- ◆ *Any kind of oil other than AR Spray could cause the O-rings to swell up and make it hard to put on and take off the handpiece. Especially avoid the use of vegetable oils made by companies other than MORITA. These could get inside the handpiece and damage it.*
- ◆ *Use only the specified O-rings.*

(3) Reconnect the handpiece and run it to make sure it works properly.



(3) Replacing the Lamp Cartridge for the Threeway Syringe (with light) (option)

! WARNING

- *Be sure to turn off the main switch before doing this. Otherwise, there is a risk of electric shock and burns.*

⚠ CAUTION

- *The lamp and lamp cover are extremely hot right after the light burns out. Avoid burns by not touching these parts until they cool off.*

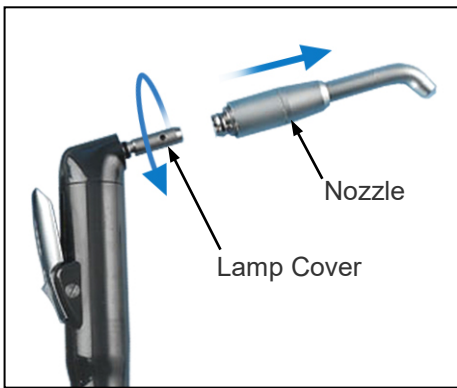

- (1) Take the nozzle off the syringe and remove the lamp cover by turning it in the direction indicated by the arrow in the illustration.

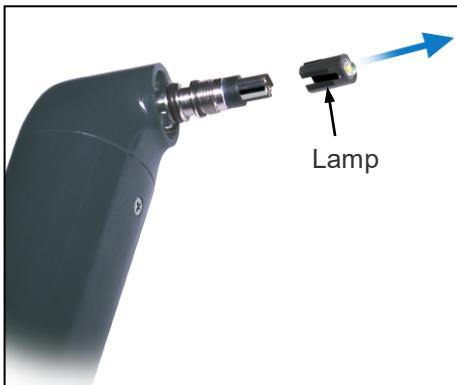

- (2) Pull the old lamp out of its socket.

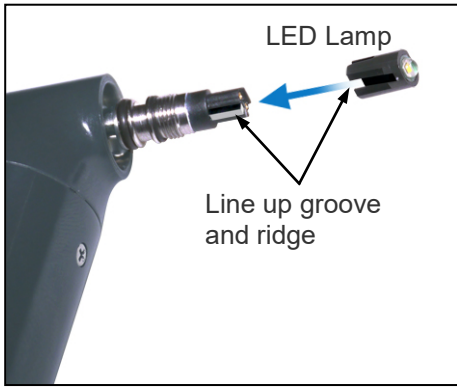

- (3) Line up the groove on the new lamp with the ridge on the lamp holder and push it straight in.

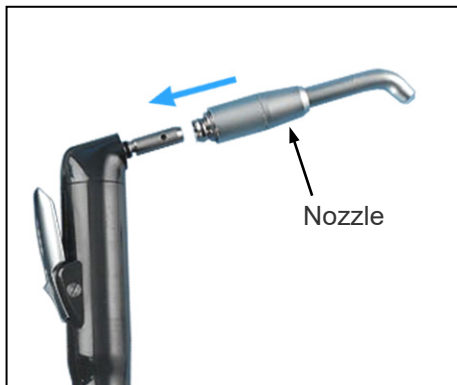

- (4) Replace the lamp cover securely and push the nozzle back on until there is an audible click. Operate the syringe to make sure the new lamp works.

CAUTION

- *Make sure there is an audible click when putting the nozzle on the threeway syringe and that the nozzle is securely fixed to the syringe. Otherwise, the nozzle could be blown off the end of the syringe and injure someone.*

(4) Clean Spittoon Valve



Refer to the Durr Company's user manual for instructions on cleaning this valve.

(5) Amalgam Separator



For countries which have law using an amalgam separator, the SPACELINE EMCIA can be equipped the amalgam separator internally.

For detail instruction, see the instruction for use of the amalgam separator.

Maintenance of the amalgam separator

- * Always wear surgical gloves when doing this.
- * The Vacuum System Auto Cleaning will be disabled.

1. Turn off the main switch. Open the maintenance box.
2. For the details of maintenance methods, see the instruction for use of the amalgam separator.

(6) Combi Separator



The SPACELINE EMCIA can be equipped with the Combi-Sepamatic (DÜRR dental, CS 1) which separates liquids but is not an amalgam separator.

Pay attention to the manufacturer's manual for how to use this device.

See "(5) Amalgam Separator" for how to access this device for maintenance and other details.

4. Storage

- * Temperature: -10°C to +70°C (+14°F to +158°F)
Humidity: 10% to 85% (without condensation)
Atmospheric Pressure: 70 kPa to 106 kPa
No frequent or continuous exposure to direct sunlight.
- * If the unit or some instrument has not been used for some time, make sure the chair, High Speed and Micromotor handpieces, threeway syringes, vacuum syringe and so on work properly before using it again.

Maintenance and Inspection

Regular Inspection

- * Maintenance and inspection are generally considered to be the duty and obligation of the user, but if, for some reason, the user is unable to carry out these duties, he may rely on a qualified medical device serviceman. Contact your local dealer or J. MORITA OFFICE for details.
- * The SPACELINE EMCIA should be inspected for all the items in the following list once every 6 months.

Regular Inspection Checklist

Chair

1. Check main power supply voltage.
Use an analog or digital tester to measure the voltage. Standard: 220, 230, 240 V \pm 10%.
2. Floor and attachment to floor.
Visual inspection. Make sure floor is level and chair attachment has not loosened up.
3. Manual chair movement.
Move the seat and backrest up and down 3 times with the levers on the foot control to make sure that it operates normally.
4. Automatic chair movement.
Use the auto position switches to move the chair 3 times and make sure it works normally. Jerky or squeaky movement should be considered abnormal.
5. Emergency stop.
Put the chair into auto positioning and use the pedals, levers and switches listed below to stop it. Repeat this 3 times.
1: High Pedal 2: Low Pedal 3: Seat and Backrest Levers 4: Auto Positioning Switches
6. Headrest
Adjust the headrest manually and make sure it works properly and smoothly. Repeat each of the following adjustments 3 times.
1: Vertical slide 2: Vertical lock 3: Vertical lock release 4: Angle of headrest
7. Electrical wiring
Check the electrical wiring for all printed circuit boards, components and elements.
1: Make sure all printed circuit board connections are secure.
2: Check for frayed or damaged insulation.
3: Check for broken, bent, twisted, or pinched wires.
4: Confirm that the ground is connected properly.
8. Hydraulic System
Move the chair with the seat and backrest levers or auto positioning switches and check the following components for oil leakage and abnormal noise: 1. Motor pump 2. Solenoid valve and servo valve 3. Elevation cylinder 4. Tilt cylinder 5. Thin flexible tubing
9. Tubes and pipes for drain, water, air and vacuum
Visually inspect the tubing and pipes inside the unit.
Check for bent, pinched or bloated tubes.
Visually inspect tubing for drain and vacuum for damage, hardening (brittleness) and wear. Make sure connections do not leak.
Bleed (remove water from) the air tubes, regulator and compressor.
10. Bacteria Filter Cases
Visually inspect the cases including the threads and bottom for cracks and chips.

11. Seat and backrest
Make sure the seat and backrest are secure and stable and that they move without wobbling or squeaking.
12. Screw tightness.
Make sure all screws and bolts both inside and outside are in place and properly tightened.
13. Internal cleanliness
Look for dirt, dust or other contamination inside the unit and clean it as necessary.
14. Water Line Flushing System
Check the following points:
 1. Fluid level in bottle goes down when lines are being flushed with the cleanser solution.
 2. Water flows through the cup filler spout and the main tubes when being flushed with tap water
 3. Flush lamp blinks and stays on as it should
 4. Bottle cap is tightened up properly

High Speed Handpiece

15. Handpiece and tube connections.
Attach and detach handpieces 3 times. Make sure the connections are safe and secure.
16. Air Pressure
Operate the handpieces and check the internal pressure gauge.
Standard: 0.35 MPa.
17. Water and air connections and lamp.
Make sure no air or water leaks from the handpiece-tube connection and that the lamp works.

Low Speed Motor

18. Rotation and Spray
Rotates properly in both directions (forward and reverse) and delivers spray
19. Air, water and electricity
Check the electrical leads in the connection end of the main tube.
Make sure there is no air or water leakage.

Threeway Syringe

20. Threeway Syringes
Check threeway syringes for the following.
 - 1: Emits water, air and spray when the levers are pressed.
 - 2: Make sure the lock between the levers disables the water lever.
 - 3: Nozzle connection, rotation, and removal.
 - 4: Levers do not wobble or twist.
 - 5: Body and case can be separated and put together again.
 - 6: Leakage at the syringe-tube connection.

Vacuum Syringe

21. Vacuum Syringe
Check for the following:
 - 1: Syringe suction start and stop.
 - 2: Tube connection and syringe rotation.
 - 3: Body and tube connection attachment and detachment and damage or wear.
 - 4: Leakage at the syringe-tube connection.
 - 5: Press the auto-cleaning switch and make sure that the vacuum line and tank are cleaned.

Main Tubes

22. Handpiece and Threeway and Vacuum Syringe Main Tubes
Pull the instruments out and return them 3 times to make sure the stoppers for their main tubes work properly.

Basin

23. Cup filler

Manual : Put a cup in place and press the manual filler switch to make sure it works.

Auto : Put a cup in place and make sure it is filled to the proper level and that the basin is rinsed at the same time.

24. Basin

1: Check visually for cracks, chipping etc.

2: Hold edges and turn to check secure attachment.

25. One-touch Connectors

1: Make sure the water and air flow properly.

2: Make sure there is no leakage.

Tray

26. Tray Arm Joints Movement and Braking Screw Integrity

Make sure tray arm does not wobble and moves smoothly.

Visually inspect arm joints for cracks, wear, or other damage.

Make sure joints do not wobble, are not loose and will not come apart.

Make sure all screws are properly tightened and will not come out.

* For the amalgam separator, refer to the separate user manuals for this component.

* For repairs, contact your local dealer or the MORITA OFFICE.

Troubleshooting

If the equipment does not seem to be working properly, the user should first try to inspect and adjust it himself.

- * If the user is unable to inspect the equipment himself or if the equipment fails to work properly after being adjusted or after parts are replaced, contact your local dealer or J. MORITA OFFICE.
- ◆ Before inspection and adjustment, check to see if the main switch is on and if the main water and air valves are open.

1. Chair

Chair does not move

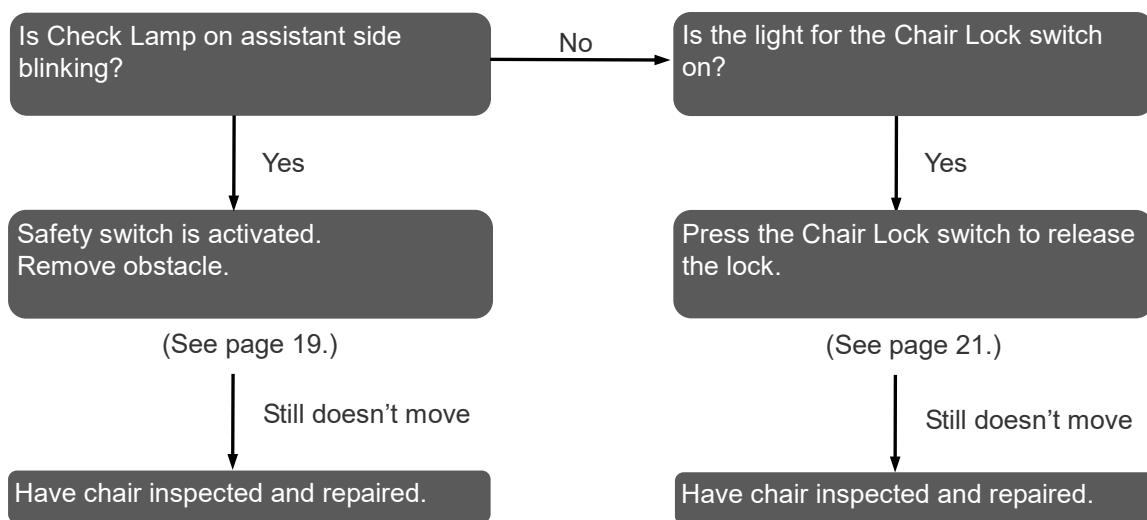

2. Air Turbine Handpieces

Air Turbine does not run

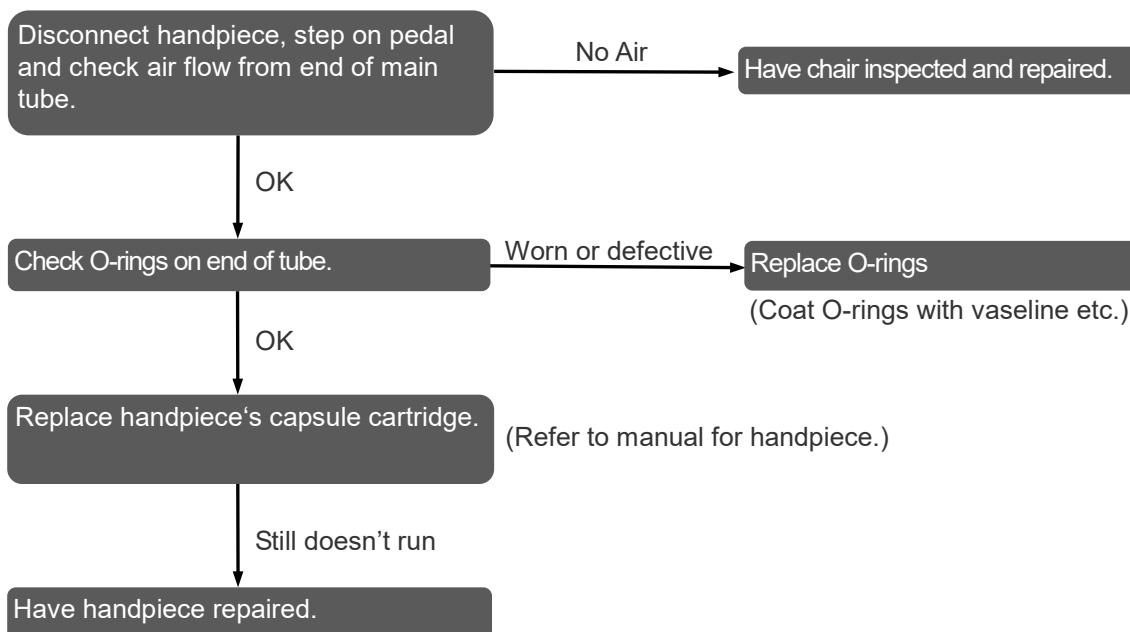

No handpiece spray

- ◆ Make sure the HP Water switch is on.

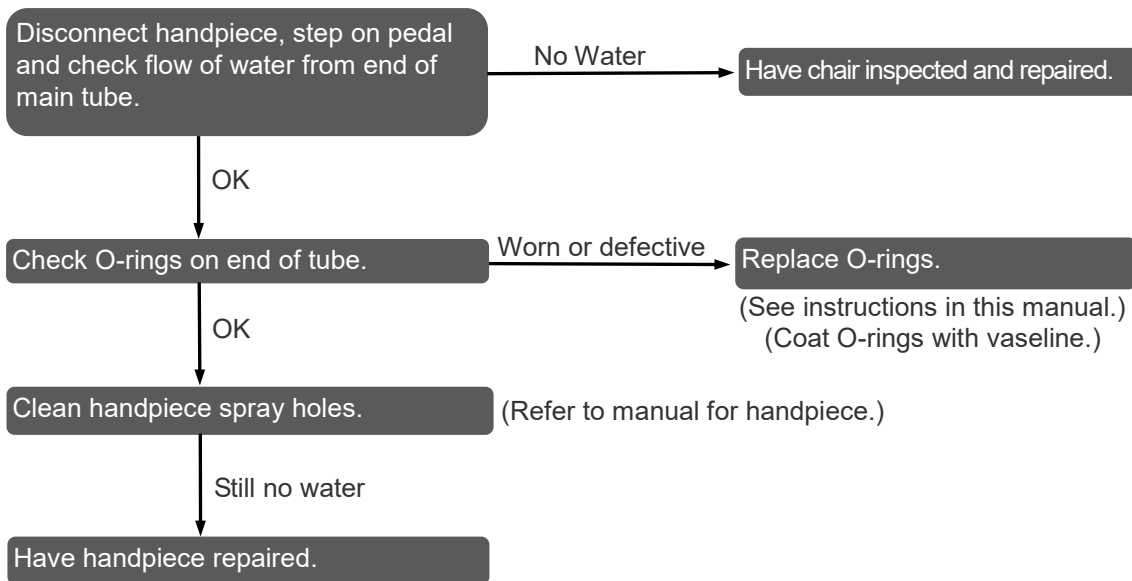

Handpiece light does not come on

- ◆ Make sure HP Light Switch is turned on.

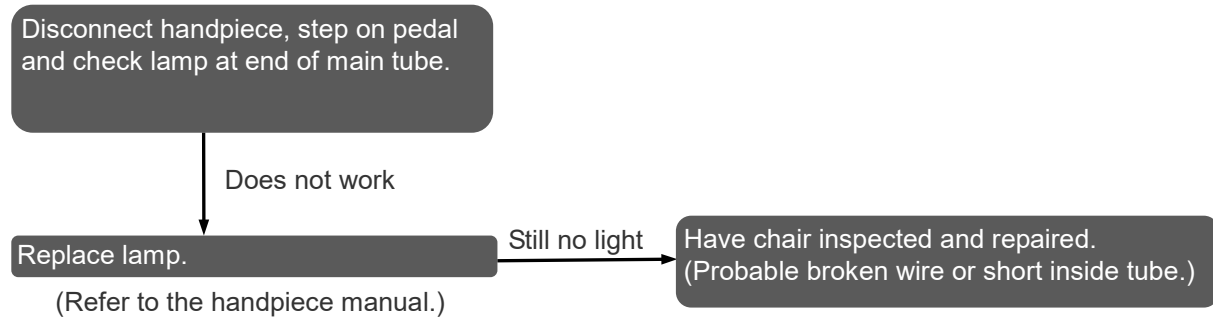

Usage Note

- ◆ *If the lamp cover is loose, use the lamp cover wrench to tighten it.*

3. TORX (TR-S2 series)

Attachments will not operate

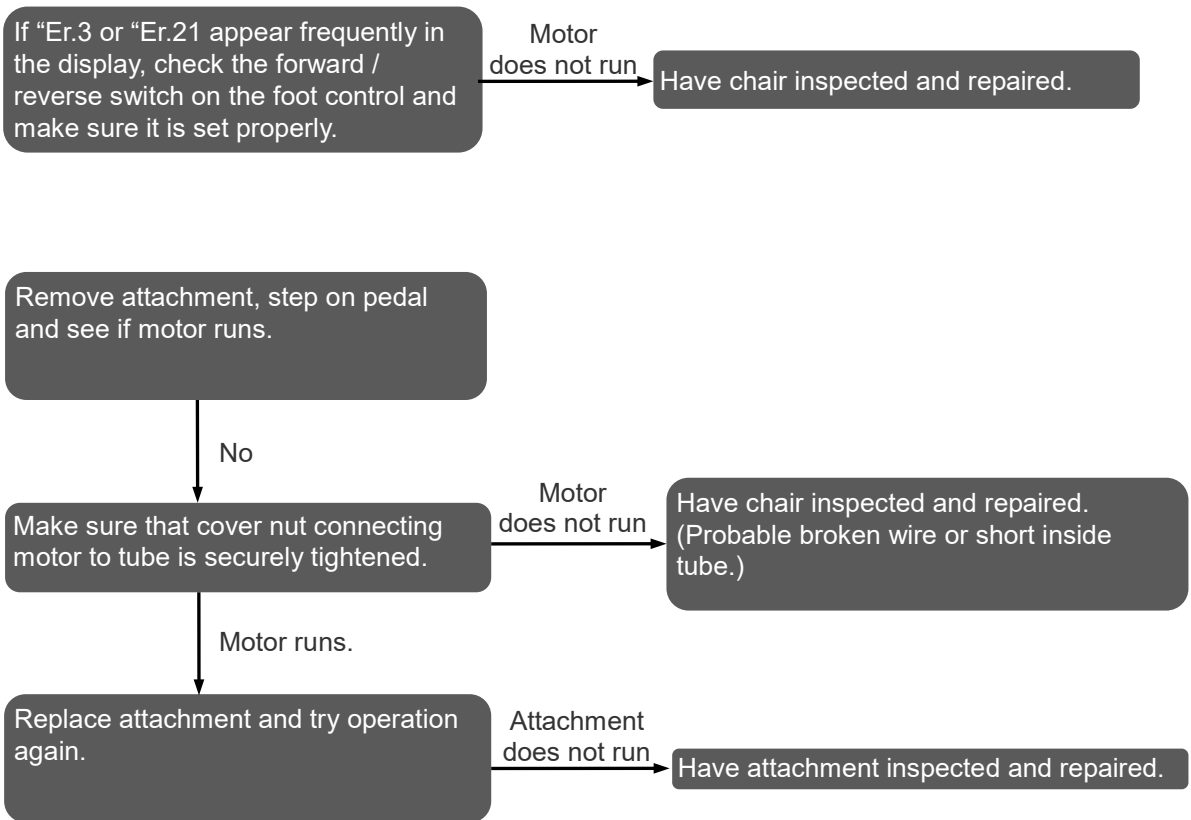

No spray for micromotor attachment

- ◆ Make sure HP Water Switch is turned on.

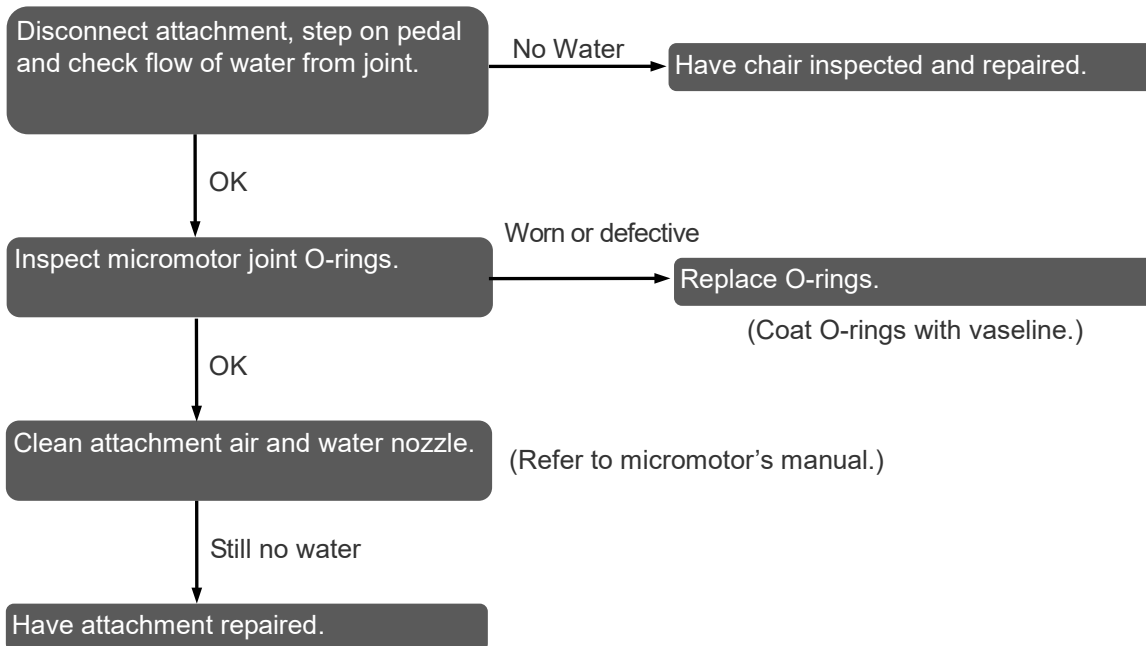

Micromotor light does not work

- ◆ Make sure HP Light Switch is turned on.

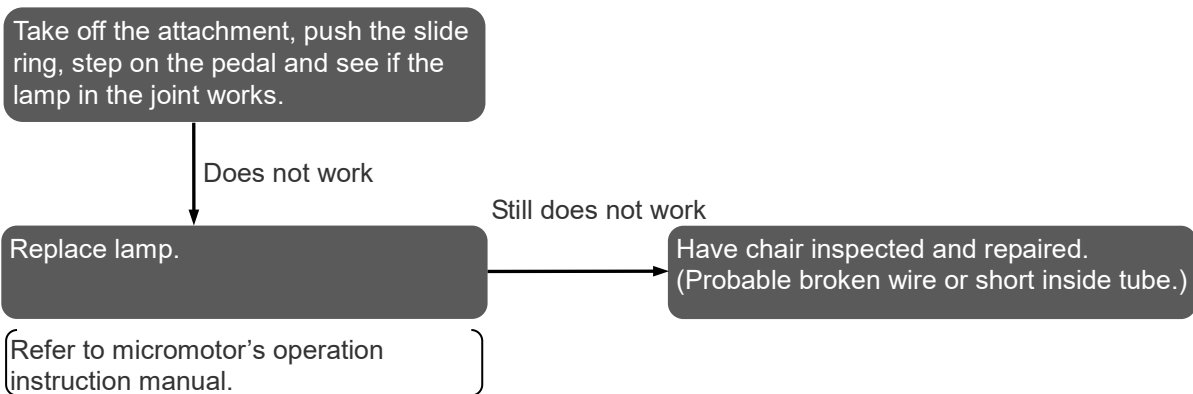

4. Torx Air Motor

Attachment does not work

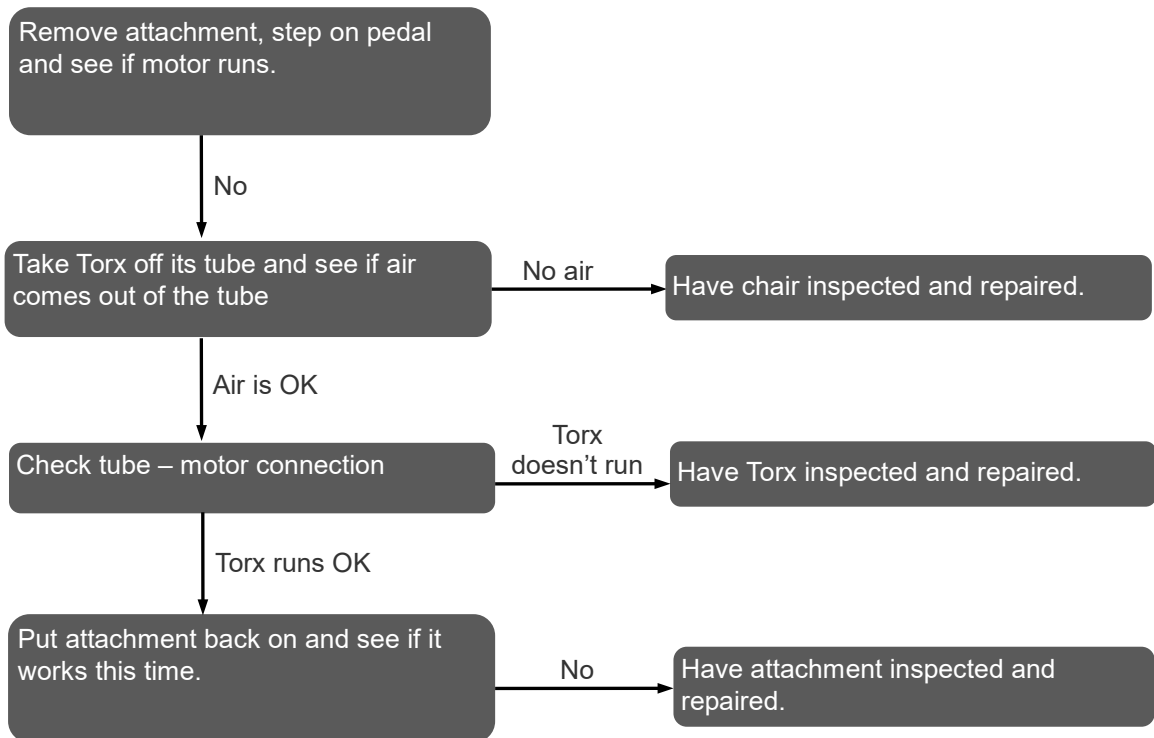

No Spray for Attachment

- ◆ Make sure HP Water Switch is turned on.

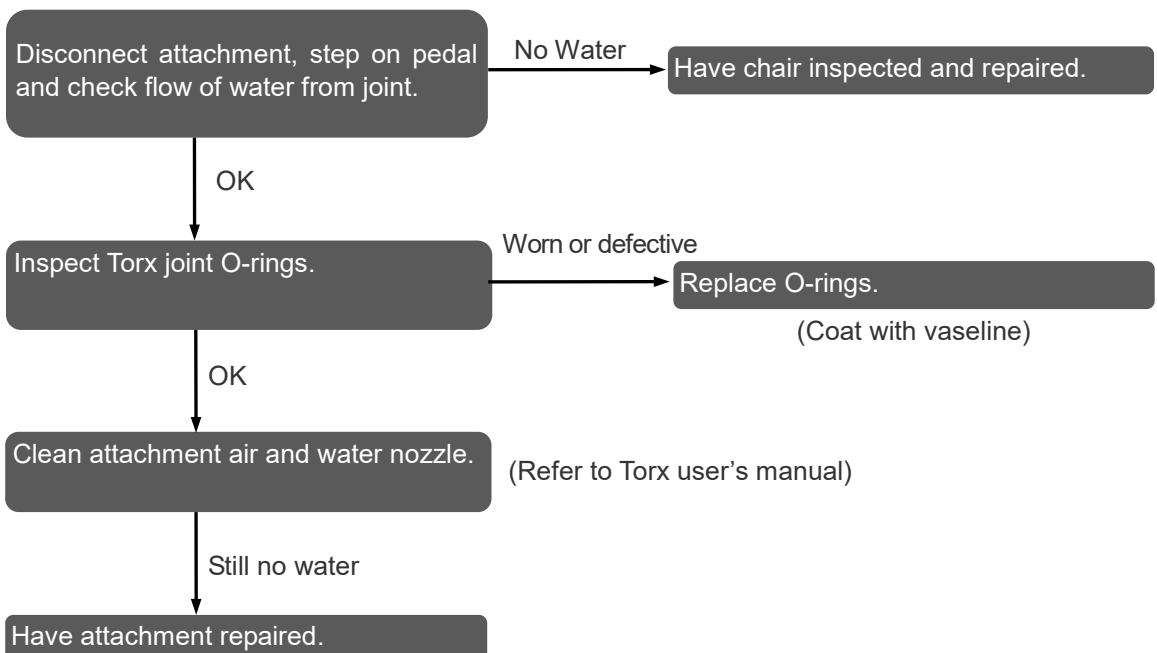

5. Threeway Syringe

No air or no water

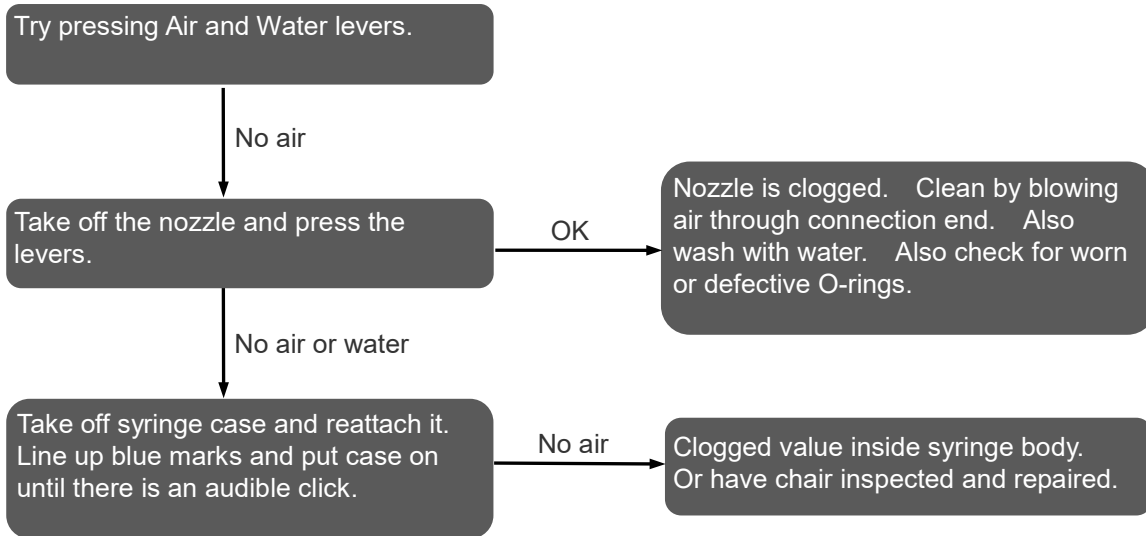

Syringe light does not come on

- ◆ Make sure HP Light Switch is turned on.

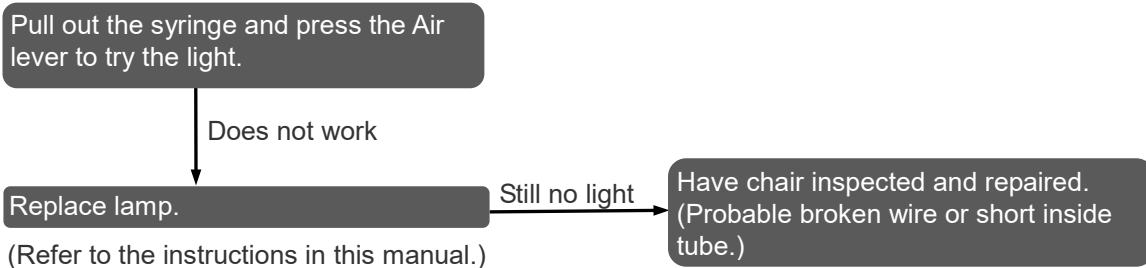

Usage Note

- ◆ *If the lamp cover is loose, use the lamp cover wrench to tighten it.*

6. Vacuum Syringe

Weak suction

- ◆ Make sure HP Light Switch is turned on.

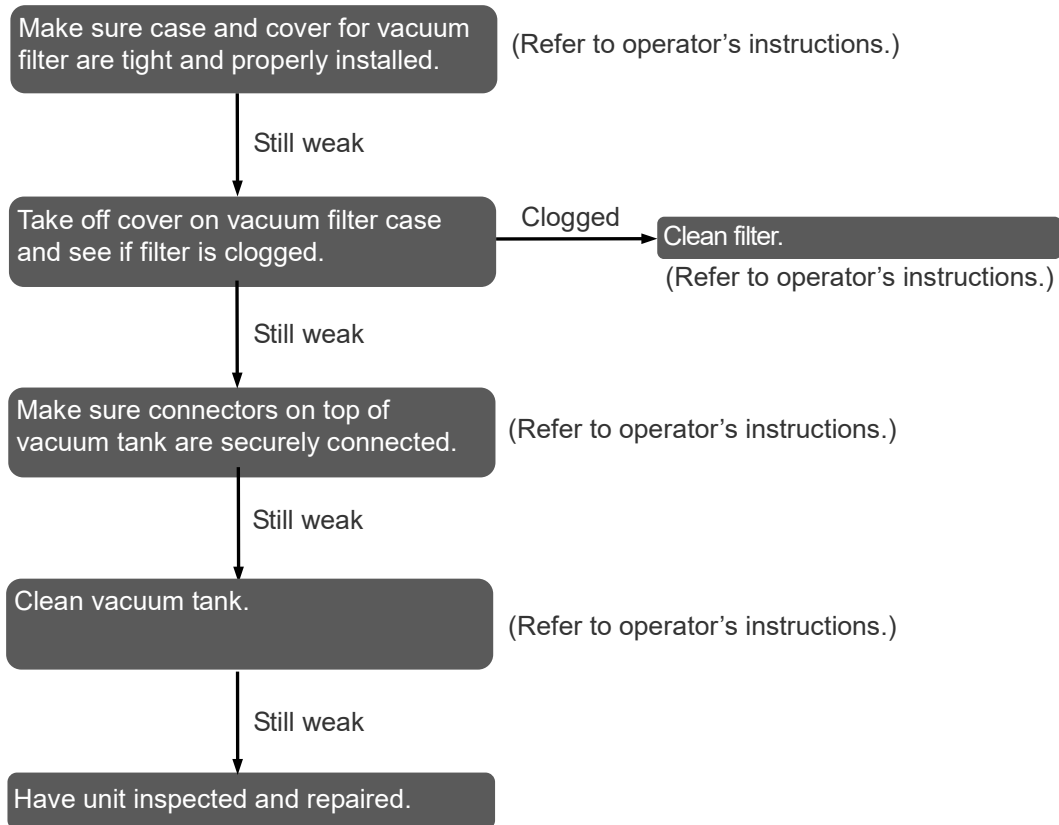

7. Basin

Basin water drains too slowly or is sluggish

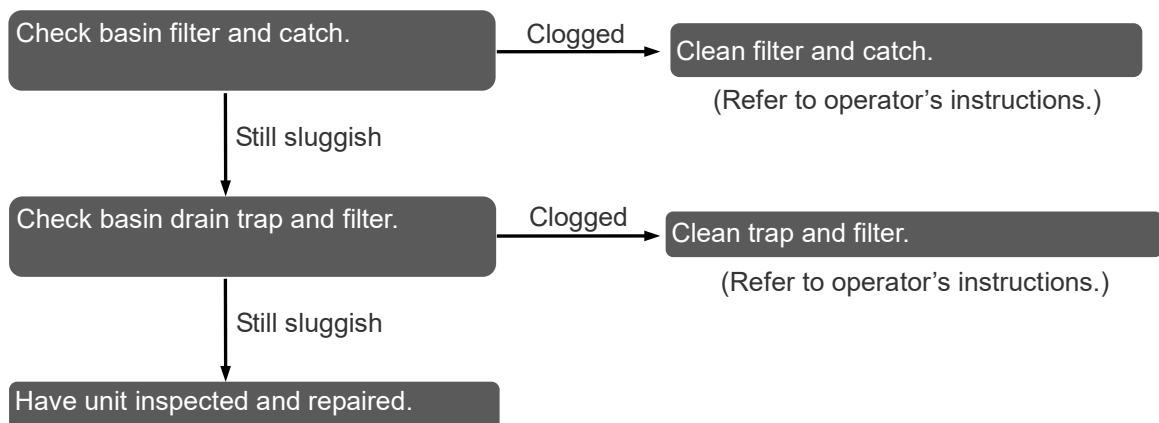

8. Auto Cup Filler

Does not work

See if sensor on water spout is wet or dirty.

Clean sensor, if necessary.

9. Luna Vue LD Light

Light does not turn on

◆ *Make sure light switches on the light itself and the foot control are turned on.*

Replace Lamp.
(Refer to operator instructions for light.)

Still no light

Have inspected and repaired.
(Probable broken wire or short in light head or arm.)

10. Water Line Flushing System

Cannot connect water tube into operation panel or bottle.

Water leaks from connector

Reconnect the water tube.

Cannot connect

Have unit inspected and repaired.

Procedure

1. Close water valve.
2. Loosen lock nut, and then disconnect tube.
3. Make sure water tube and its connector are not damaged, deformed, or covered with dirt or debris.
4. Fasten lock nut, and then plug water tube straight in.



Usage Note

- ◆ *If the blue water tube is hard to put on or take off, coat the O-ring on the lock nut with a little vaseline.*

Technical Specifications

Specifications

* Specifications may be changed without prior notice due to improvements.

Name	SPACELINE EMCIA		
Model	CU-580-UP		
Type	PdW		
Intended Use	<p>The CU-580-UP is a general dental treatment unit. It is intended to be used for maintaining the patient's position and giving following operations as appropriate.</p> <ul style="list-style-type: none"> • Drilling or cutting teeth and prosthetic appliance to be removed • Cleaning and drying patient's oral cavity • Vacuuming saliva, cooling water, etc. from oral cavity • Periodontal treatment • Visualizing oral cavity • Composite resin restoration • Pulp extirpation and root canal treatment • Light irradiation to oral cavity 		
Essential Performance	None		
Rated Input Voltage	AC 220/230/240 V (Adjusted to Local Line)		
Frequency	50 / 60 Hz		
Input	0.9kVA (220VAC), 1.0kVA (230VAC), 1.1kVA (240VAC)		
Electric Shock Protection	Class I (permanent installation), Type B, applied parts		
Classification of Protection against Harmful Ingress of Water	IPX1 (foot control) *1		
Water Input Pressure	0.20 to 0.59 MPa		
Air Input Pressure	0.39 to 0.78 MPa		
Mode of Operation	Maximum 1 min on / Minimum 4 mins off (hydraulic motor)		
Chair Control Valves	Combination of solenoid and servo valves		
Threeway Syringes			
Water Flow	60 ml / 15 sec. (minimum)		
Spray Flow	60 ml / 15 sec. (minimum)		
Vacuum Syringe			
Suction Rate	140 L / min. (minimum) (with EV-12 type II vacuum motor)		
Vacuum Degree	9.3 kPa (minimum) (with EV-12 type II vacuum motor)		
Dimensions			
Chair	Wid. 680 × Leng. 1,830 mm / (FT) Wid. 680 × Leng. 1,770 mm		
Seat Height			
Maximum	780 ±10 mm		
Minimum	450 + ¹⁰ / ₀ mm		
Backrest Angle			
Raised	75° ⁰ / ₋₃		(FT) 85° ⁰ / ₋₅
Lowered	0° ⁺² / ₀		(FT) 0° ⁺³ / ₀
Tilt Angle	_____ /		(FT) -5° ⁺² / ₀
Weight	Approx. 200 kg / (FT) Approx. 220 kg		

Applied Parts	
<ul style="list-style-type: none"> • Air turbine • Micro motor • Scaler • Light polymerizer • Three way syringe • Vacuum syringe 	<ul style="list-style-type: none"> • Saliva ejector • Seat • Back seat • Arm rest • Head rest • Basin bowl
Accessories	
<ul style="list-style-type: none"> • Air turbine • Micro motor • Scaler (manufactured by our company) • Light polymerizer • Saliva ejector 	<ul style="list-style-type: none"> • Three way syringe • Vacuum tip • Vacuum nozzle • Tray sheet
Operating Conditions	
<ul style="list-style-type: none"> • Temperature: +10°C to +35°C (+50°F to 95°F) • Atmospheric Pressure: 70 kPa to 106 kPa 	<ul style="list-style-type: none"> • Humidity: 30% to 75% (without condensation)
Storage and Transportation Conditions	
<ul style="list-style-type: none"> • Temperature: -10°C to +70°C (+14°F to +158°F) • Atmospheric Pressure: 70 kPa to 106 kPa 	<ul style="list-style-type: none"> • Humidity: 10% to 85% (without condensation)
ME System	
<ul style="list-style-type: none"> • Computer • Monitor (used within patient environment) 	
Requirements for computers connected to CU-580-UP	
<ul style="list-style-type: none"> • IEC 60950 • EMC regulation 	<ul style="list-style-type: none"> • Install outside patient environment • Local regulations
Requirements for monitors connected to CU-580-UP	
<ul style="list-style-type: none"> • IEC 60950 • EMC regulation 	<ul style="list-style-type: none"> • Local regulations

*1 Refrain from the use of the SPACELINE EMCIA in areas with wet floors such as emergency rooms or operating rooms.

Userbility Statement

















The CU-580-UP conforms to the Standard IEC 62366:2007 for usability.

Use this device with the following application specifications.

Patient Population	
Age	Child (with a first tooth) to Geriatric
Weight	Not over 135 kg body weight
Health	It is not intended for use on patients wearing pacemakers or ICDs.
Condition	Conscious and mentally alert person. (Person who can stay still during treatment.)
Part of the body or type of tissue applied to or interacted with	
Teeth, gingiva, or skin	
Intended Operator	
Qualified and licensed dental treatment professionals	
User Qualifications	
Qualified and licensed dental treatment Dentist and Doctor Qualified and licensed dental treatment Hygienist	
Language Understanding	English

Symbols

* Some symbols may not be used.

	Serial number		Manufacturer
	CE(0197) marking Conforms with the European Directive, 93/42/EEC. CE marking Conforms with the European Directive, 2011/65/EU.		Date of manufacture
	Unique device identifier		Medical device
	WEEE marking Conforms with the WEEE Directive		Alternating current
	Type B applied part		Type BF applied part
	Refer to instructions for use		GS1 DataMatrix
	Mandatory action	IPX1	IP code Liquid ingress protection: Level 1
	This way up		Fragile
	Keep away from rain		Temperature limitation
	Humidity limitation		Atmospheric pressure limitation
	Authorized representative in the European Community		

Service and Other Contacts

- * For repair or other types of service contact your local dealer or J. MORITA OFFICE.
- * Disposal of Medical Devices
Any medical devices which could possibly be contaminated must be first decontaminated by the responsible doctor or medical institution and then be disposed by an agent licensed and qualified to handle medical and industrial waste.
- * Service
The SPACELINE EMCIA may be repaired and serviced by:
 - The technicians of J. MORITA's subsidiaries all over the world.
 - Technicians employed by authorized J. MORITA dealers and specially trained by J. MORITA.
 - Independent technicians specially trained and authorized by J. MORITA.



Alert Indicators

The following alert indicators are located on the tray, shoulders and the panel for the water line flushing system.

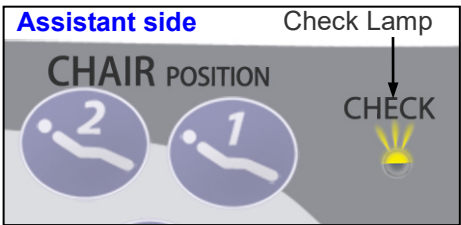
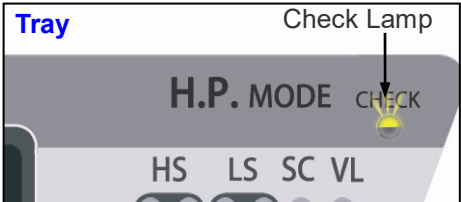
■Tray and Shoulders

Indicator	Meaning	Response
 <p>Assistant side Check Lamp</p>	<p>A safety circuit has been activated. (Chair contacted an obstacle during movement.)</p>	<p>Remove the obstacle that activated the circuit. See page 19.</p>
 <p>Tray Check Lamp</p>		

■Water Line Flushing System

Flush Lamp	Meaning	Response
<p>Blinking</p> 	<p>Do not use for treatment.</p>	<p>Flush cleanser out of water lines with tap water.</p>
<p>Stays On Not Blinking</p> 	<p>OK to use for treatment.</p>	

Electromagnetic Disturbances (EMD)

The SPACELINE EMCIA (hereafter "this device") conforms to IEC 60601-1-2:2014 Ed. 4.0, the relevant international standard for electromagnetic disturbances (EMD).

The following is the "Guidance and Manufacturer's Declaration" which is required by IEC 60601-1-2:2014 Ed. 4.0, the relevant international standard for electromagnetic disturbances.

This is a Group 1, Class B product according to EN 55011 (CISPR 11).

This means that this device does not generate and/or use internationally radio-frequency energy, in the form of electromagnetic radiation, inductive and/or capacitive coupling, for the treatment of material or inspection/analysis purpose and that it is suitable for use in domestic establishments and in establishments directly connected to a low voltage power supply network which supplies buildings use for domestic purposes.

Guidance and Manufacturer's Declaration – Electromagnetic Emissions		
This device is intended for use in the electromagnetic environment specified below. The customer or the user of this device should assure that it is used in such an environment.		
Emissions Test	Compliance	Electromagnetic Environment – Guidance
Conducted disturbance CISPR 11	Group 1 Class B	This device is suitable for use in all establishments, including domestic establishments and those directly connected to the public low-voltage power supply network that supplies buildings used for domestic purposes.
Radiated disturbance CISPR 11	Group 1 Class B	
Harmonic current IEC 61000-3-2	Class A	
Voltage fluctuations and flicker IEC 61000-3-3	Clause 5	

WARNING

- *The use environment of this device is the Professional healthcare facility environment.*
- *This device needs special precautions regarding EMD and needs to be installed and put into service according to the EMD information provided in the ACCOMPANYING DOCUMENTS.*
- *Use of parts other than those accompanied or specified by J. MORITA MFG CORP. could result in increased electromagnetic emissions or decreased electromagnetic immunity of this device and result in improper operation.*
- *Do not use this device as adjacent or stacked as possible with other. When adjoining or stacking is necessary, use it after observing whether this equipment and other equipment work properly.*
- *Portable and mobile RF communications equipment (including peripherals such as antenna cables and external antennas) should be used no closer than 30 cm to any part of the CU-580-UP, including cables specified by the manufacturer.*

Guidance and Manufacturer's Declaration – Electromagnetic Immunity			
This device is intended for use in the electromagnetic environment specified below. The customer or the user of this device should assure that it is used in such an environment.			
Immunity Test	IEC 60601 Test Level	Compliance Level	Electromagnetic Environment – Guidance
Electrostatic discharge (ESD) IEC 61000-4-2	±8 kV contact ±2 kV, ±4 kV, ±8 kV, ±15 kV air	±8 kV contact ±2 kV, ±4 kV, ±8 kV, ±15 kV air	Floors should be wood, concrete or ceramic tile. If floors are covered with synthetic material, the relative humidity should be at least 30%.
Electrical fast transients/bursts IEC 61000-4-4	±2 kV for power supply lines ±1 kV for input/output lines	±2 kV for power supply lines ±1 kV for input/output lines	Mains power quality should be that of a typical commercial or hospital environment.
Surge IEC 61000-4-5	<u>AC/DC power</u> ±0.5 kV, ±1 kV line(s) to line(s) ±0.5 kV, ±1 kV, ±2 kV line(s) to earth <u>Signal input/output</u> ±2 kV line(s) to earth	<u>AC/DC power</u> ±0.5 kV, ±1 kV line(s) to line(s) ±0.5 kV, ±1 kV, ±2 kV line(s) to earth <u>Signal input/output</u> — (*1)	Mains power quality should be that of a typical commercial or hospital environment.
Voltage dips, short interruptions and voltage variations on power supply lines IEC 61000-4-11	<u>dips</u> 0% U_T : 0.5 cycle (at 0, 45, 90, 135, 180, 225, 270, 315°) 0% U_T : 1 cycle (at 0°) 70% U_T : 25/30 cycles (at 0°) 25 (50 Hz)/30 (60 Hz) <u>short interruptions</u> 0% U_T : 250/300 cycles 250 (50 Hz)/300 (60 Hz)	<u>dips</u> 0% U_T : 0.5 cycle (at 0, 45, 90, 135, 180, 225, 270, 315°) 0% U_T : 1 cycle (at 0, 180°) 70% U_T : 25 cycles (at 0, 180°) 50 Hz <u>short interruptions</u> 0% U_T : 250 cycles 50 Hz	Mains power quality should be that of a typical commercial or hospital environment. If user of this device requires continued operation during power mains interruptions, it is recommended that this device be powered from an uninterruptible power supply or a battery.
Power frequency (50/60 Hz) magnetic field IEC 61000-4-8	30 A/m (r.m.s.) 50 Hz or 60 Hz	30 A/m (r.m.s.) 50 Hz	Power frequency magnetic field should be at levels characteristic of a typical location in a typical commercial or hospital environment.
NOTE 1: U_T is the a.c. mains voltage prior to application of the test level. NOTE 2: r.m.s.: root mean square			

*1: Not applicable because it does not connect directly to outdoor cable.

Guidance and Manufacturer's Declaration – Electromagnetic Immunity

This device is intended for use in the electromagnetic environment specified below.
The customer or the user of this device should assure that it is used in such an environment.

Immunity Test	IEC 60601 Test Level	Compliance Level	Electromagnetic Environment – Guidance
Conducted RF IEC 61000-4-6	3 V ISM ^(c) / amateur radio frequency band: 6 V 150 kHz to 80 MHz	3 V ISM ^(c) / amateur radio frequency band: 6 V 150 kHz to 80 MHz	<p>Portable and mobile RF communications equipment should be used no closer to any part of this device, including cables, than the recommended separation distance calculated from the equation applicable to the frequency of the transmitter.</p> <p>Recommended separation distances $d = 1.2 \sqrt{P}$ 150 kHz to 80 MHz $d = 1.2 \sqrt{P}$ 80 MHz to 800 MHz $d = 2.3 \sqrt{P}$ 800 MHz to 2.7 GHz $d = \frac{6}{E} \sqrt{P}$ Portable wireless RF communication equipment</p> <p>Where P is the maximum output power rating of the transmitter in watts (W) according to the transmitter manufacturer, E is the compliance level in V/m and d is the recommended separation distance in meters (m).</p> <p>Field strengths from field RF transmitters, as determined by an electromagnetic site survey^(a), should be less than the compliance level in each frequency range^(b).</p> <p>Interference may occur in the vicinity of equipment marked with the following symbol:</p> 
Radiated RF IEC 61000-4-3	3 V/m 80 MHz to 2.7 GHz	3 V/m 80 MHz to 2.7 GHz	
	27 V/m 385 MHz	27 V/m 385 MHz	
	28 V/m 450 MHz	28 V/m 450 MHz	
	9 V/m 710, 745, 780 MHz	9 V/m 710, 745, 780 MHz	
	28 V/m 810, 870, 930, MHz	28 V/m 810, 870, 930, MHz	
	28 V/m 1720, 1845, 1970 MHz	28 V/m 1720, 1845, 1970 MHz	
	28 V/m 2450 MHz	28 V/m 2450 MHz	
	9 V/m 5240, 5500, 5785 MHz	9 V/m 5240, 5500, 5785 MHz	

NOTE 1: At 80 MHz and 800 MHz, the higher frequency range applies.

NOTE 2: These guidelines may not apply in all situations. Electromagnetic propagation is affected by absorption and reflection from structures, objects and people.

(a) Field strengths from fixed transmitters, such as base stations for radio (cellular/cordless) telephones and land mobile radios, amateur radio, AM and FM radio broadcast and TV broadcast cannot be predicated theoretically with accuracy. To assess the electromagnetic environment due to fixed RF transmitters, an electromagnetic site survey should be considered. If the measured field strength in the location in which this device is used exceeds the applicable RF compliance level above, this device should be observed to verify normal operation. If abnormal performance is observed, additional measures may be necessary, such as reorienting or relocating this device.

(b) Over the frequency range 150 kHz to 80 MHz, field strengths should be less than 3 V/m.

(c) The ISM (Industrial, Scientific and Medical) bands between 0.15 MHz and 80 MHz are 6.765 MHz to 6.795 MHz; 13.553 MHz to 13.567 MHz; 26.957 MHz to 27.283 MHz; and 40.66 MHz to 40.70 MHz.

Essential Performance

None

Cable List

No.	Interface(s):	Max. Cable Length, Shielding	Cable Classification
1.	WS-10-O-LD Main Tube	1.6 m, Un-shielded	Signal Line (Patient-Coupled cable)
2.	HS Main Tube (SFSO-1-LD)	1.6 m, Un-shielded	Signal Line (Patient-Coupled cable)
3.	HS Main Tube (ST-WH-O)	1.6 m, Un-shielded	Signal Line (Patient-Coupled cable)
4.	TR-S2-O Main Tube	1.6 m, Un-shielded	Signal Line (Patient-Coupled cable)
5.	SC-7000 (-O) Main Tube	1.6 m, Un-shielded	Signal Line (Patient-Coupled cable)
6.	WS-12 Main Tube	1.7 m, Un-shielded	Signal Line (Patient-Coupled cable)
7.	Foot Control Cable	0.7 m, Un-shielded	Signal Line
8.	External Vacuum Cable	5.0 m, Un-shielded	Signal Line
9.	RGB Cable	2.0 m, Shielded	Signal Line
10.	Power Cable for LCD Monitor	2.0 m, Un-shielded	DC Power Line



Development and Manufacturing

J. MORITA MFG. CORP.

680 Higashihama Minami-cho, Fushimi-ku, Kyoto 612-8533, Japan
T +81. (0)75. 611 2141, F +81. (0)75. 622 4595

Morita Global Website
www.morita.com

Distribution

J. MORITA CORP.

3-33-18 Tarumi-cho, Suita-shi, Osaka 564-8650, Japan
T +81. (0)6. 6380 1521, F +81. (0)6. 6380 0585

J. MORITA USA, INC.

9 Mason, Irvine CA 92618, USA
T +1. 949. 581 9600, F +1. 949. 581 8811

J. MORITA EUROPE GMBH

Justus-von-Liebig-Strasse 27b, 63128 Dietzenbach, Germany
T +49. (0)6074. 836 0, F +49. (0)6074. 836 299

MORITA DENTAL ASIA PTE. LTD.

150 Kampong Ampat #06-01A KA Centre, Singapore 368324
T +65. 6779. 4795, F +65. 6777. 2279

J. MORITA CORP. AUSTRALIA & NEW ZEALAND

Suite 2.05, 247 Coward Street, Mascot NSW 2020, Australia
T +61. (0)2. 9667 3555, F +61. (0)2. 9667 3577

J. MORITA CORP. MIDDLE EAST

4 Tag Al Roasaa, Apartment 902, Saba Pacha 21311 Alexandria, Egypt
T +20. (0)3. 58 222 94, F +20. (0)3. 58 222 96

J. MORITA CORP. INDIA

Filix Office No.908, L.B.S. Marg, Opp. Asian Paints, Bhandup (West), Mumbai 400078, India
T +91-22-2595-3482

J. MORITA MFG. CORP. INDONESIA

28F, DBS Bank Tower, Jl. Prof. Dr. Satrio Kav. 3-5, Jakarta 12940, Indonesia
T +62-21-2988-8332, F + 62-21-2988-8201

SIAMDENT CO., LTD.

71/10 Mu 5, Thakham, Bangpakong, Chachuengsao 24130, Thailand
T +66. 38. 573042, F +66. 38. 573043
www.siamdent.com

EU Authorized Representative under the European Directive 93/42/EEC



MEDICAL TECHNOLOGY PROMEDT CONSULTING GmbH

Altenhofstraße 80, 66386 St. Ingbert, Germany T +49. 6894 581020, F +49. 6894 581021

The authority granted to the authorized representative, MEDICAL TECHNOLOGY PROMEDT Consulting GmbH, by J. MORITA MFG. CORP. is solely limited to the work of the authorized representative with the requirements of the European Directive 93/42/EEC for product registration and incident report.

Diagnostic and Imaging Equipment

Treatment Units

Handpieces and Instruments

Endodontic Systems

Laser Equipment

Laboratory Devices

Educational and Training Systems

Auxiliaries