



Apex Locator



Canal Measurement Module

INSTRUCTIONS FOR USE

This is the Canal Measurement Module. The OTR Module (sold separately) can be easily connected to this module so that preparation can be performed while measuring the canal.



Manufactured by **J.MORITA MFG.CORP.**

Thank you for purchasing ROOT ZX II Canal Measurement Module.

For optimum safety and performance, read this manual thoroughly before using the unit and pay close attention to warnings and notes. Keep this manual in a readily accessible place for quick and easy reference. This manual contains essential safety information.

■ Trademarks (™) and Registered Trademarks (®):

The names of companies, products, services, etc. used in this manual are either trademarks or registered trademarks owned by each company.

© 2008 J. MORITA MFG. CORP.

Table of Contents

	Page
1. Prevent Accidents	1
2. Parts Identification	6
3. Assembling the Unit	7
4. Before Using the Unit	8
Connecting the Probe Cord	8
Checking the Function	8
Checking the Function with the Tester	9
5. Operating the Unit	10
Operation Panel Display and Switches	10
Setting and Changing Memory	11
Meter Display	12
Operating the Unit	13
Root Canals not suitable for Electronic Measurement Reading (EMR)	15
EMR and Radiography	17
6. After Using the Unit	18
7. Maintenance	20
Autoclavable Components	20
Non-Autoclavable Components: Wipe with Ethanol	23
Non-Autoclavable Components: Wipe with Neutral Detergent and Moistened Cloth	24
8. Replacement Parts	25
9. Storage	25
10. Inspection	25
11. Troubleshooting	26
12. Replacement Parts List	27
13. Technical Specifications	28
Appendix- Electromagnetic declaration	30
14. Warranty	34

1. Prevent Accidents

Most operation and maintenance problems result from insufficient attention being paid to basic safety precautions and not being able to foresee the possibilities of accidents.

Problems and accidents are best avoided by foreseeing the possibility of danger and operating the unit in accordance with the manufacturer's recommendations.

First thoroughly read all precautions and instructions pertaining to safety and accident prevention; then, operate the equipment with the utmost caution to prevent either damaging the equipment itself or causing bodily injury.

Note the meaning of the following symbols and expressions:

WARNING

This warns that it may result in serious injury of the patient or operator if the instructions are not followed properly.

PROHIBITION

The user can not use in such a way that may result in serious injury of the patient or operator.

CAUTION

This alerts the user to the possibility of damage to the equipment, potential injury of the patient or operator, or important points concerning operation and performance.

The user (e.g. the hospital, clinic etc.) is the party responsible for the maintenance and proper operation of ROOT ZX II dental device.

ROOT ZX II dental device must only be operated by dentists and other legally licensed professionals.

Do not use this equipment for anything other than its specified purpose.

⚠ WARNING

- *This unit must not be connected to or used in combination with any other apparatus or system. It must not be used as an integral component of any other apparatus or system.
J. MORITA MFG. CORP. will not be responsible for accidents, equipment damage, bodily injury or any other trouble which results from ignoring this prohibition.*
- *Accurate canal measurement is not always possible depending on the shape and condition of the tooth as well as a decline in the equipment's performance.*
- *Do not use damaged file holders; an accurate measurement can not be made with a damaged file holder.*
- *When continuous tone is heard while the main power switch is on and without any operation, some electrical part may be malfunction. Do not use the unit and send the unit to J. MORITA regional office for repairing.*
- *This unit is for prescription use only.*
- *A rubber dam should be used when performing endodontic treatment.*
- *Caution: US Federal law restricts this unit to sale by or on the order of a dentist in U.S.A.*
- *Check the unit's operation before each patient. If the indicators in the display do not all appear normally, the instrument may not be able to make an accurate measurement. In this case, stop using the instrument and have it repaired. (see page 9)*
- *Never use the unit if the battery power indicator is flashing on and off. The unit will not function properly if the battery power is low. (see page 10)*
- *Check the settings displayed after selecting memories. (see page 11)*
- *In some cases such as a blocked canal, a measurement cannot be made. (see page 12)*
- *Always check the measurement with an x ray. In some cases, an accurate measurement cannot be made because of the canal shape, unusual cases, or poor performance of the instrument. (see page 12)*
- *Stop using the instrument immediately if you sense something odd or abnormal while taking a measurement. (see page 12)*
- *Do not use an ultrasonic scaler with the contrary electrode attached to the patient. This is dangerous because electrical noise from the scaler could interfere with canal measurements and motor operation. (see page 13)*
- *Make sure that the contrary electrode, file holder, handpiece file electrode, etc., do not come into contact with an electric power source such as an electrical socket. This could result in a severe electrical shock. (see page 13)*
- *Do not use the unit if the battery power display is flashing. The unit may not function properly if the battery power is low. (see page 18)*
- *Autoclave file holder and contrary electrode after each patient. (see page 20)*
- *The DP-ZX-VL needs special precaution regarding EMC and needs to be installed and put into service according to the EMC information provided in the Accompanying Documents.*
- *Portable and mobile RF communications equipment can affect the DP-ZX-VL.*
- *Use of the parts other than those accompanied or specified by J. MORITA MFG. CORP. may result in increased EMC emissions or decreased EMC immunity of the DP-ZX-VL.*
- *The DP-ZX-VL should not be used adjacent to or stacked with other equipment and that if adjacent or stacked use is necessary, the DP-ZX-VL should be observed to verify normal operation in the configuration in which it will be used.*

⚠ PROHIBITION

- *Do not use this unit in conjunction with an electric scalpel or on patients who have a pacemaker.*
- *Do not use this unit in the medical operation room.*
- *Blocked canals cannot be accurately measured.*
- *This unit must not be connected to or used in combination with any other apparatus or system. It must not be used as an integral component of any other apparatus or system.*
J. MORITA MFG. CORP. will not be responsible for accidents, equipment damage, bodily injury or any other trouble which results from ignoring this prohibition.
- *Illumination devices such as fluorescent lights and the Film viewer which use an inverter can cause ROOT ZX II to operate erratically. Do not use ROOT ZX II near devices such as these.*
- *Electromagnetic wave interference could cause this device to operate in an abnormal, random and possibly dangerous manner. Cellular phone, transceivers, remote controls and all other devices which transmit electromagnetic waves located inside the building should be turned off.*

⚠ CAUTION

- *Canal Measurement Module is shipped without the batteries installed. Remove the cover and install the 3 AA batteries. (see page 7)*
- *Do not reverse the plus and minus poles. (see page 7, 19)*
- *Never allow the spring contact to push against the edge of the battery. This could damage the outer cover causing a short or a leakage of battery liquid. (see page 7, 19)*
- *If the catch on the bottom is not back in its original place after attachment, push it in the direction shown by the arrow in the illustration. (see page 7, 19)*
- *After installation, give the cover a light tug to confirm it is securely attached. (see page 7, 19)*
- *Handle Canal Measurement Module carefully; do not drop, bump or expose it to other kinds of impacts or shocks. Rough handling could cause damage. (see page 8)*
- *Make sure the plug is securely plugged into the jack. A poor connection can cause malfunction. (see page 8)*
- *Do not drop anything on or bang the plug after it has been inserted into the jack. (see page 8)*
- *Make sure to match colors of the file holder and contrary electrode to the probe cord. (see page 8)*
- *Measurements cannot be made if these connections are reversed. (see page 8)*
- *Do not let the file touch the gums. This will cause the meter to jump to Apex. (see page 12)*
- *If the canal is extremely dry, the meter may not move until it is quite close to the apex. If the meter does not move, try moistening the canal with oxydol or saline. (see page 12)*
- *Occasionally the canal length indicator bar makes a sudden and large movement as soon as the file is inserted into the root canal, but it will return to normal as the file is advanced down towards the apex. (see page 12)*
- *The contrary electrode could cause an adverse reaction if the patient has an allergy to metals. Ask the patient about this before using the contrary electrode. (see page 13)*

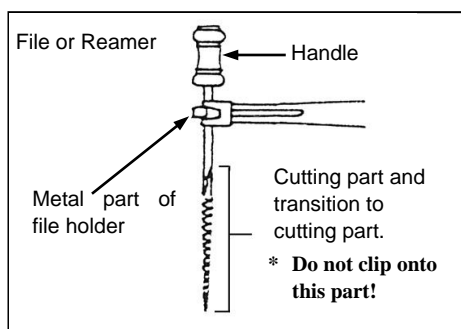

- *Take care that medicinal solutions such as formalin cresol (FC) or sodium hypochlorite do not get on the contrary electrode or the file holder. These could cause an adverse reaction such as inflammation. (see page 13)*
- *Always clip the file holder to the upper part of file shaft, near the handle. The metal and plastic part of the file holder can be damaged if they are attached to the file's cutting part or the transition to the cutting part. (see page 13)*

- *Use files and reamers with plastic handles only. If the file has a metal handle, electrical leakage will occur when the handle is touched by fingers and it will prevent an accurate root canal measurement. Even if the file handle is made of plastic, make sure not to touch the metal part of the file with finger. (see page 14)*
- *Do not use damaged file holders. An accurate measurement cannot be made using a damaged file holder. (see page 14)*
- *Clip the file as shown in illustration #1 below. If the file is forced into the position shown in illustration #2, it may not make an accurate measurement and the file holder could be damaged. (see page 14)*

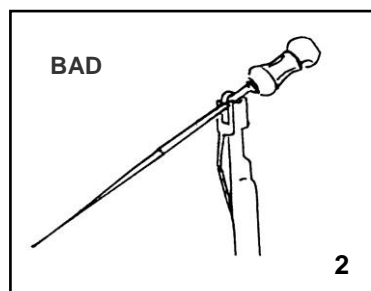
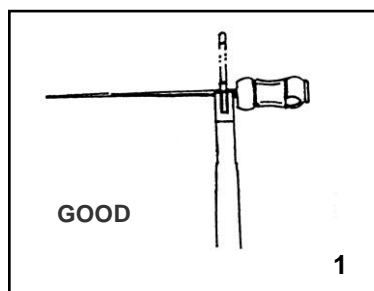

⚠ CAUTION

- *Make sure to take an x-ray to check the results. (see page 14)*

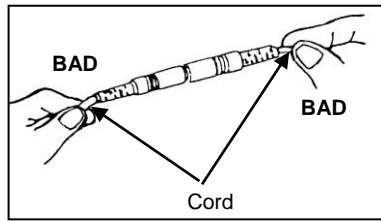



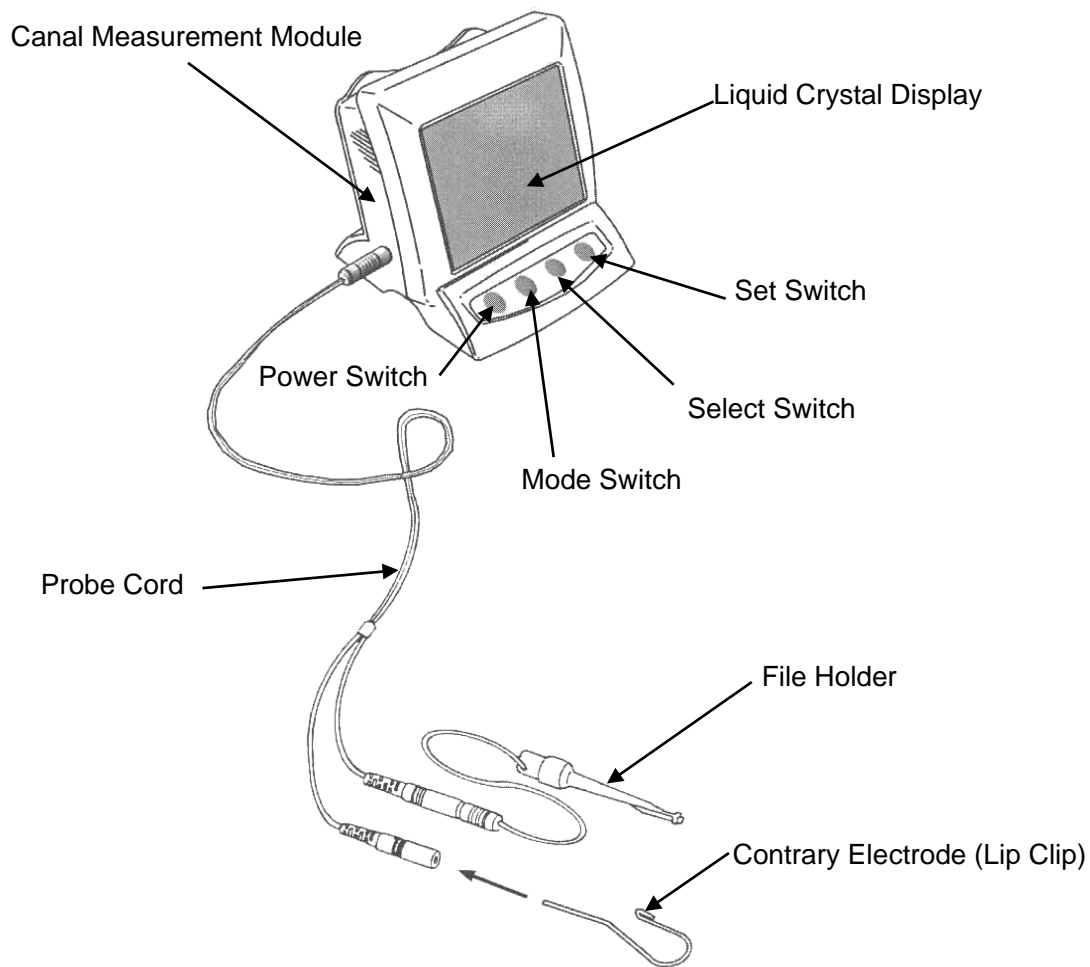

- *When disconnecting and connecting the contrary electrode, probe cord and file holder, never pull or push on the cords themselves; always grip the connectors. (see page 18)*
- *Do not wrap the probe cord around the body of the main tube. (see page 18)*
- *Always use alkaline AA batteries. (see page 19)*
- *Never use rechargeable nickel-hydrogen or nickel-cadmium batteries. (see page 19)*
- *Replace all three batteries at the same time. (see page 19)*
- *Make sure that the plus and minus poles are correctly aligned. (see page 19)*
- *Never use batteries that are leaky, deformed, discolored or otherwise abnormal. (see page 19)*
- *Dispose of old batteries according to local codes and regulations. (see page 19)*
- *In case of battery leakage, carefully dry the battery terminals and remove all of the leaked liquid. Replace the battery with a new one. (see page 19)*
- *Do not sterilize in any way other than autoclave. (see page 20)*
- *Thoroughly clean and wash the components before autoclaving. If chemical solutions or foreign debris are not removed, autoclaving could damage or deform the components. (see page 20)*
- *Autoclave and dry temperatures must not exceed 135°C (275°F). (see page 20)*
- *It is highly recommended to put the contents in a sterilization pouch for autoclaving. (see page 20)*
- *Never autoclave probe cord. (see page 20)*
- *Never wipe probe cord with any type of alcohol except ethanol (70 vol% to 80 vol%). (see page 20)*
- *Occasionally, static electricity produced by wiping the liquid crystal display with a dry cloth may affect the appearance of the display. (see page 20)*
- *Never use any type of alcohol except ethanol (70 vol% to 80 vol%). Do not use paint thinner, benzene or similar solutions to clean Canal Measurement Module main unit. (see page 20)*
- *Avoid spilling chemical solutions used for treatment on Canal Measurement Module main unit. These chemicals could damage, deform or discolor Canal Measurement Module main unit. Use extra caution to avoid spilling formalin cresol (FC) and sodium hypochlorite as they are quite strong. Wipe up any chemical spills immediately. (Some chemicals may leave traces even if wiped up immediately.) (see page 20)*

2. Parts Identification

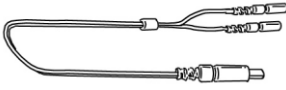
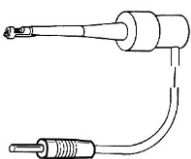

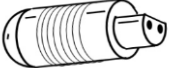
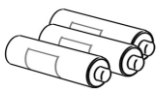
Accessories

Probe Cord (1)	File Holder (3)	Contrary Electrode (5)
		
Tester (1)	AA Battery (3)	Long File Holder (option)
		

3. Assembling the Unit

Placing the Batteries

⚠ CAUTION

- *Canal Measurement Module is shipped without the batteries installed. Remove the cover and install the 3 AA batteries.*

1. Hold the cover and slide the stopper on the bottom towards the liquid crystal display.
2. Slide the cover in the direction indicated by the arrow in the illustration and remove it from Canal Measurement Module.
3. Place the 3 AA batteries included in the package as indicated on the unit.
 - (1) Insert the batteries by first pressing center of the minus end against its spring contact and then sliding the plus end down into place.
 - (2) Make sure the contacts are not bent or damaged.

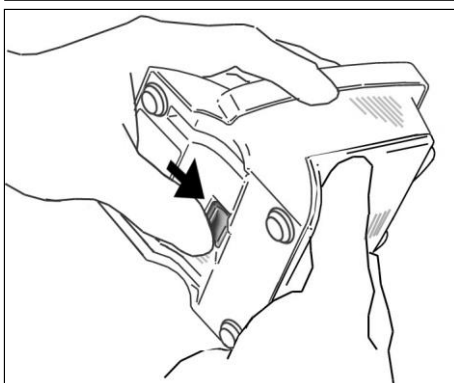
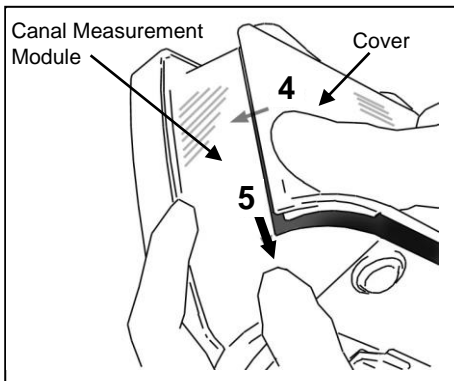
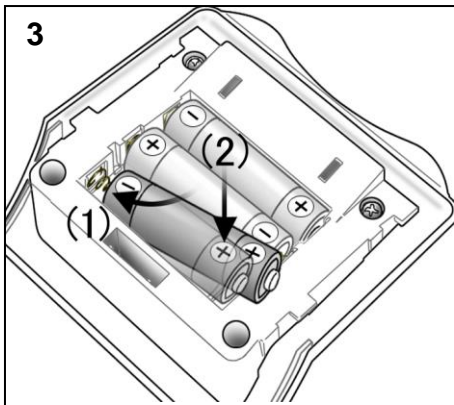
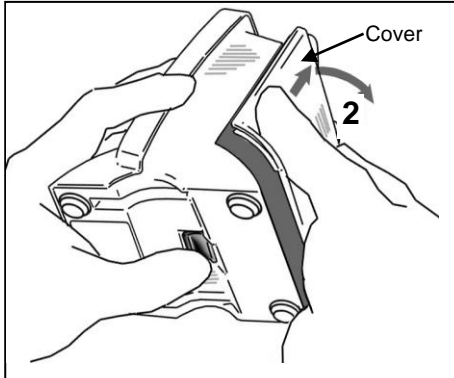
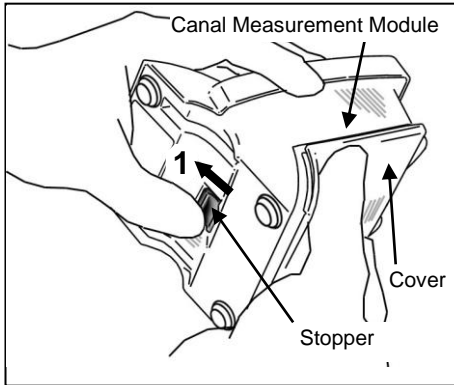

⚠ CAUTION

- *Do not reverse the plus and minus poles.*
- *Never allow the spring contact to push against the edge of the battery. This could damage the outer cover causing a short or a leakage of battery liquid.*

4. Line up the tabs on the cover with the notches on Canal Measurement Module and slide the cover on.
5. Slide the cover all the way down until it is securely attached.

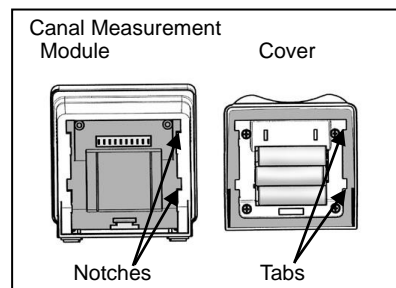

⚠ CAUTION

- *If the catch on the bottom is not back in its original place after attachment, push it in the direction shown by the arrow in the illustration.*
- *After installation, give the cover a light tug to confirm it is securely attached*

4. Before Using the Unit

Connecting the Probe Cord

1. Insert the probe cord completely into the jack on the left side of Canal Measurement Module.

⚠ CAUTION

- *Handle Canal Measurement Module carefully; do not drop, bump or expose it to other kinds of impacts or shocks. Rough handling could cause damage.*
- *Make sure the plug is securely plugged into the jack. A poor connection can cause malfunction.*
- *Do not drop anything on or bang the plug after it has been inserted into the jack.*

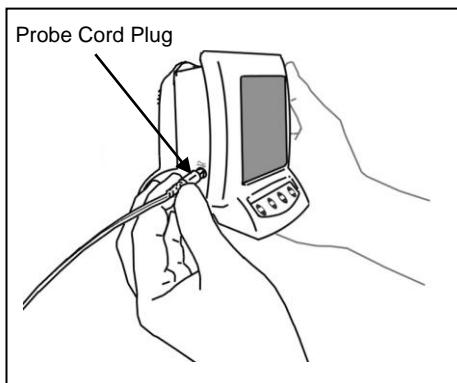

2. Insert the file holder's gray male plug into the gray female connector on the probe cord. Insert the contrary electrode into the white female connector on the probe cord.

⚠ CAUTION

- *Make sure to match colors of the file holder and contrary electrode to the probe cord.*
- *Measurements cannot be made if these connections are reversed.*

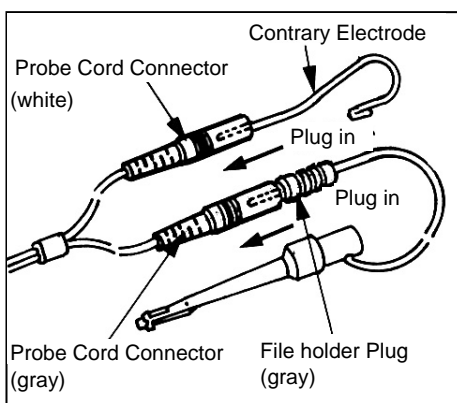

Checking the Function

This checking procedure should be followed at the beginning of every day.

1. Press the Power switch to turn on the unit. The measurement display will appear.

* The unit will automatically turn off after ten minutes of non-use.

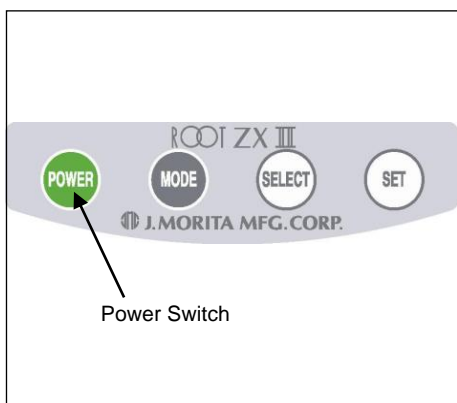

2. Check that the probe cord is properly plugged into the jack.
3. Check that the file holder and contrary electrode are properly connected to the probe cord.
4. Contact metal part of the file holder with contrary electrode.

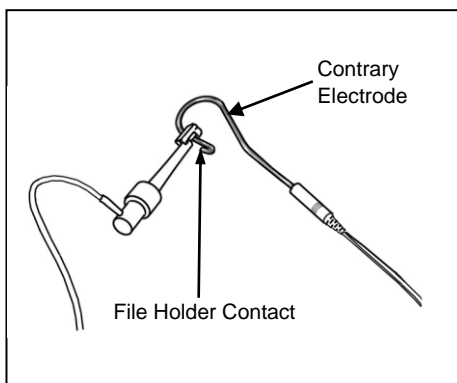

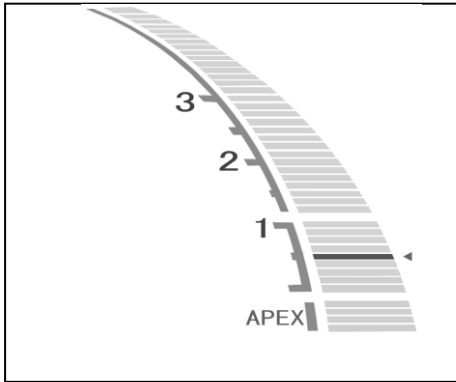

5. Check that all the canal length indicator bars on the display are lit, the word “APEX” flashes and audible beep becomes continuous.

⚠ WARNING

- *Check the unit’s operation before each patient. If the indicators in the display do not all appear normally, the instrument may not be able to make an accurate measurement. In this case, stop using the instrument and have it repaired.*

Checking the Function with the Tester

Check the root canal measurement’s performance with the tester once a week.

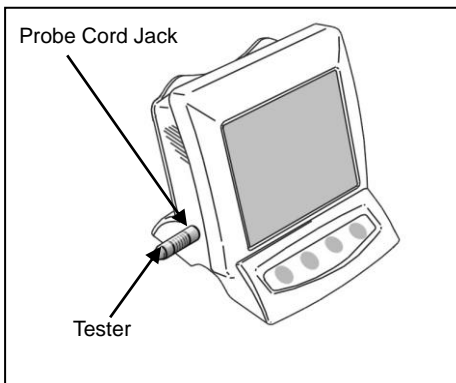

1. Press the Power switch to turn on the unit.
2. Insert the tester into the probe cord jack.

Check that the meter indicates within ± 3 bars from (above or below) the 1.

- * The meter may jump when the tester is inserted. If it does, wait for about one second until the meter stabilizes and then check the reading.

- * If the reading is 4 or more bars from the 1, the unit will not make accurate measurement. In this case, contact your local dealer or J. MORITA regional office.

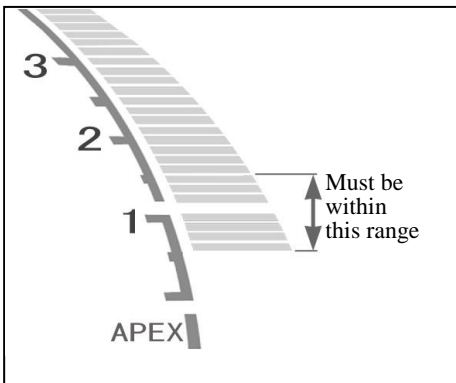

3. Remove the tester and connect the probe cord.
4. Connect the file holder and contrary electrode to the probe cord.

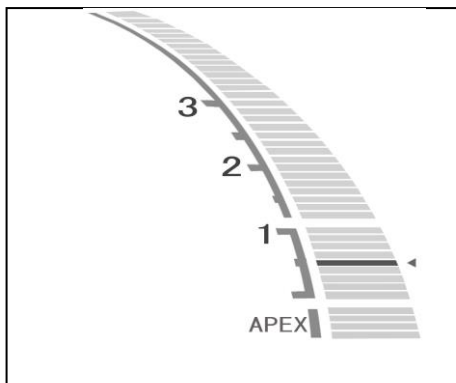

5. Contact metal part of the file holder with contrary electrode.
Check that all the canal length indicator bar on the display are lit, the word “APEX” flashes and audible beep becomes continuous.





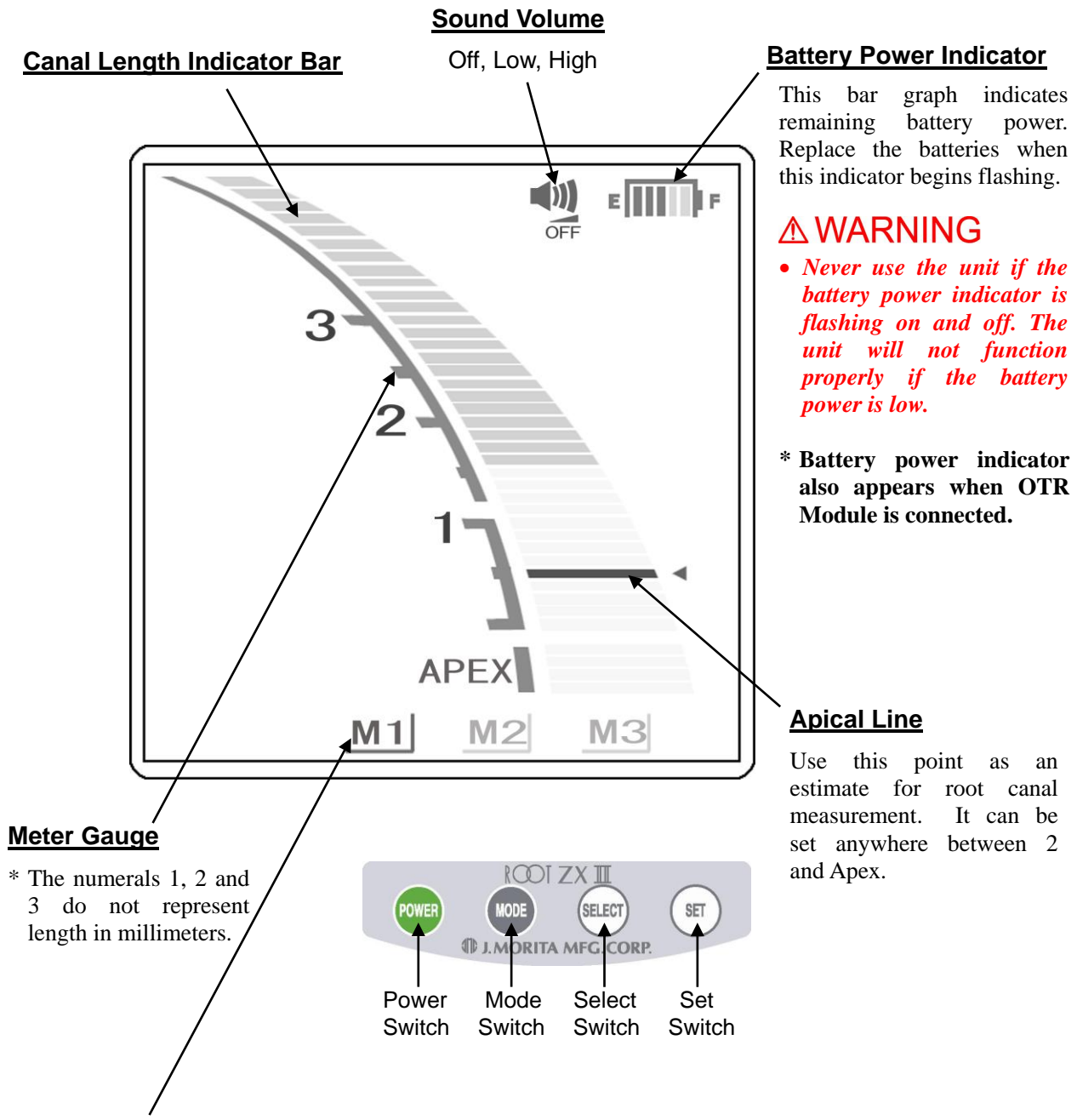



5. Operating the Unit

Operation Panel Display and Switches

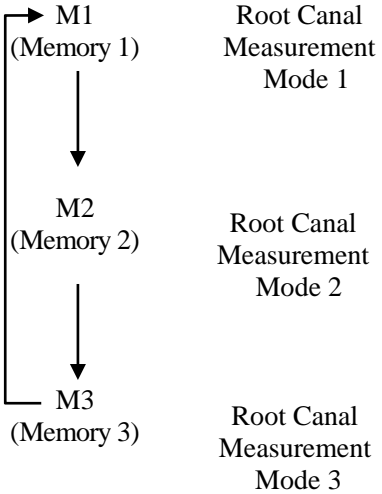

Setting and Changing Memory

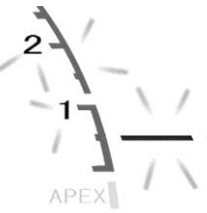
Use the Mode Switch to select M1, M2 or M3. Use the Select switch to select sound volume and Apical Line. Use the Set Switch to set the memory content.

<p>Press Mode to select the memory.</p>  Press	<p>Press Select to select the item.</p>  Press (The display will briefly flash on and off.)	<p>Press Set to set the memory content.</p>  Press	
	<p>Sound volume selected</p>  Flashes	 Turn the sound off.  Set the sound volume low.  Set the sound volume high.	
	<p>Apical Line selected.</p>  Flashes	 Apical Line	<p>The apical line can be set anywhere between 2 and Apex.</p>

* All memory settings will be retained even after the unit is turned off. Simply select M1, M2, or M3 to use those memory settings.

⚠ WARNING

- *Check the settings displayed after selecting memories.*

Alarm Sound Selection

In case 2 or more units are being used, there are two different sounds for the alarm so that you can tell one from the other. To change the sound, hold down the Set switch and turn the unit on.

- * The sound that signals switch operation will also change.
- * The sound cannot be memorized separately by the three memories (M1, M2 and M3).
- * Turn the unit off to save the selection.

Meter Display

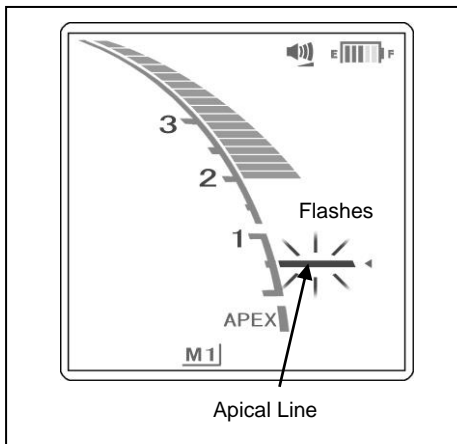

- The position of the file tip is shown by the canal length indicator bar on the display. The apical line flashes on and off once file is inserted into the root canal.

⚠ CAUTION

- *Do not let the file touch the gums. This will cause the meter to jump to Apex.*
- *If the canal is extremely dry, the meter may not move until it is quite close to the apex. If the meter does not move, try moistening the canal with oxydol or saline.*
- *Occasionally the canal length indicator bar makes a sudden and large movement as soon as the file is inserted into the root canal, but it will return to normal as the file is advanced down towards the apex.*

⚠ WARNING

- *In some cases such as a blocked canal, a measurement cannot be made. (For details, see page 15, “Root Canals not suitable for Electronic Measurement.”)*
- *Always check the measurement with an x ray. In some cases, an accurate measurement cannot be made because of the canal shape, unusual cases, or poor performance of the instrument.*
- *Stop using the instrument immediately if you sense something odd or abnormal while taking a measurement.*

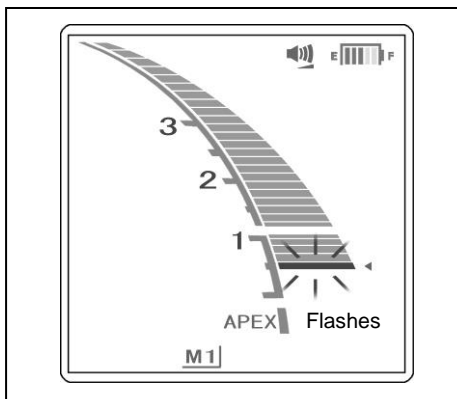

- The meter’s 0.5 reading indicates that the tip of the file is in the apical constriction.

* The numerals on the meter gauge do not represent millimeters.

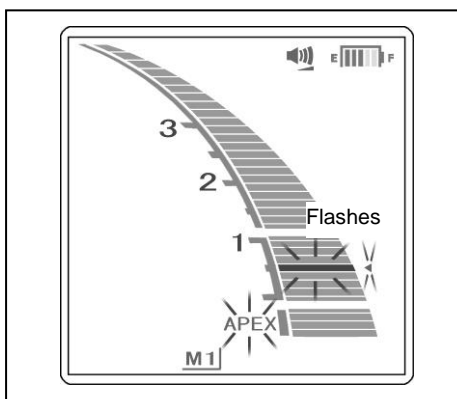

- If the file tip passes the point indicated by the apical line, the alarm sound will change from beeping to solid tone. If the file tip reaches the major foramen, the word “APEX” and the little triangle next to the apical line will start to flash.

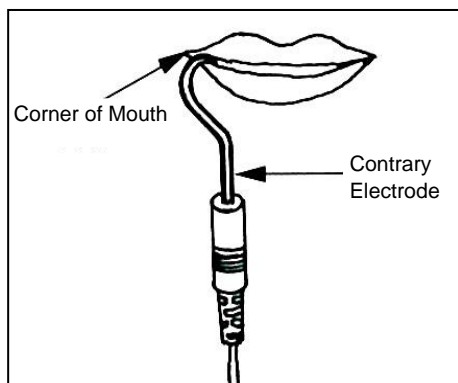

Operating the Unit

1. Turn on the unit.
2. Hook the contrary electrode in the corner of the patient's mouth.

⚠ WARNING

- *Do not use an ultrasonic scaler with the contrary electrode attached to the patient. This is dangerous because electrical noise from the scaler could interfere with canal measurements and motor operation.*
- *Make sure that the contrary electrode, file holder, handpiece file electrode, etc., do not come into contact with an electric power source such as an electrical socket. This could result in a severe electrical shock.*

⚠ CAUTION

- *The contrary electrode could cause an adverse reaction if the patient has an allergy to metals. Ask the patient about this before using the contrary electrode.*
- *Take care that medicinal solutions such as formalin cresol (FC) or sodium hypochlorite do not get on the contrary electrode or the file holder. These could cause an adverse reaction such as inflammation.*

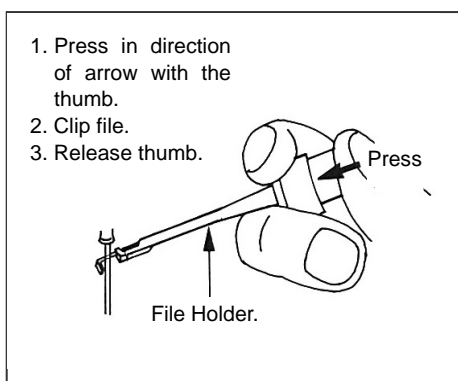

3. Clip the file holder to the metal shaft of the file.

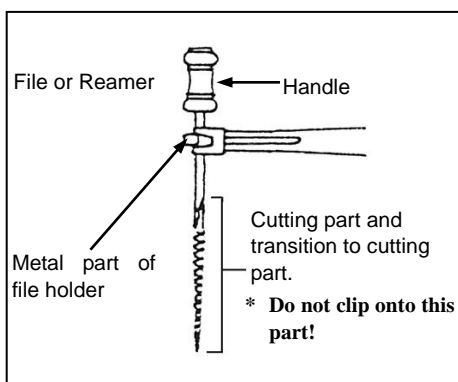

⚠ CAUTION

- *Always clip the file holder to the upper part of file shaft, near the handle. The metal and plastic part of the file holder can be damaged if they are attached to the file's cutting part or the transition to the cutting part.*

⚠ CAUTION

- Use files and reamers with plastic handles only. If the file has a metal handle, electrical leakage will occur when the handle is touched by fingers and it will prevent an accurate root canal measurement. Even if the file handle is made of plastic, make sure not to touch the metal part of the file with finger.
- Do not use damaged file holders. An accurate measurement cannot be made using a damaged file holder.
- Clip the file as shown in illustration #1 below. If the file is forced into the position shown in illustration #2, it may not make an accurate measurement and the file holder could be damaged.

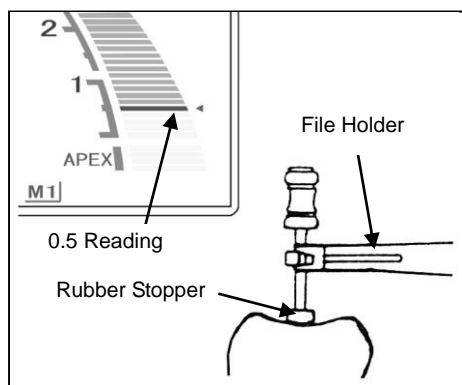
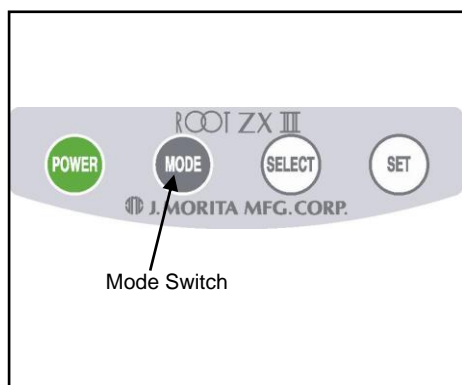
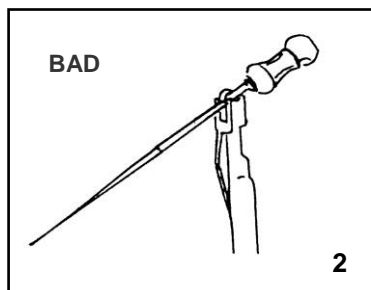
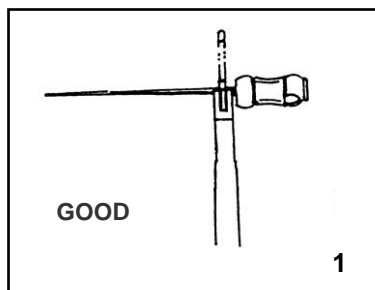

4. Press the mode switch to select memory 1, 2 or 3 (M1, M2 or M3).

* See “Setting and Changing Memory”, on page 11 for how to set the memory contents.

* While an actual measurement is being made, none of the switches, except the power switch, will work.

5. Insert the file (in most case size 10) until the meter reads 0.5 (this point can be recognized by the change in the alarm sound as well). Then advance the file with slow clockwise turns until the word “APEX” begins to flash. When the apex is reached, turn the file with slow counter clockwise turns until meter reads 0.5 again. Since some canals have multiple constrictions, it is essential that the file be taken to the apex then returned to the apical constriction (0.5 reading). Position the rubber stopper on the tooth surface as a reference point to determine the root canal’s working length.

■ **After root canal’s working length is determined, turn off the unit, disconnect the probe cord from the main unit and remove the file holder and contrary electrode from the probe cord.**

* Working length differs somewhat depending on each individual tooth. The discrepancy must be judged by the dentist.

⚠ CAUTION

- Make sure to take an x-ray to check the results.

Root Canals not suitable for Electronic Measurement Reading (EMR)

Accurate measurement cannot be obtained with the root canal conditions shown below. There may be other cases that an accurate measurement cannot be made.

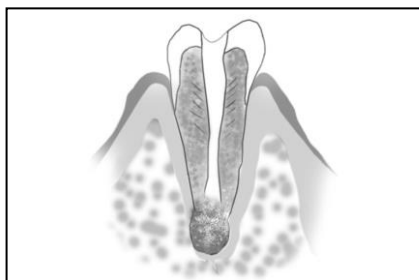

Root Canal with a large apical foramen

Root canal that has an exceptionally large apical foramen due to a lesion or incomplete development cannot be accurately measured; the results will show shorter measurement than the actual length.

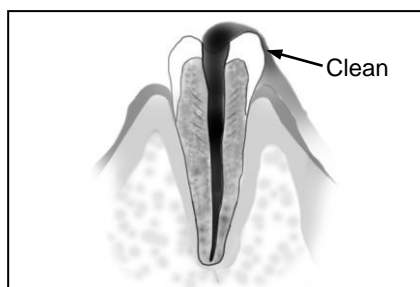

Root Canal with blood, saliva or a chemical solution overflowing from the opening

If blood, saliva, or a chemical solution overflow from the opening of the root canal and contacts the gums, this will result in electrical leakage and an accurate measurement cannot be obtained. Wait for bleeding to stop completely. Clean the inside and opening of the canal thoroughly to get rid of all blood, saliva and chemical solutions and then make a measurement.

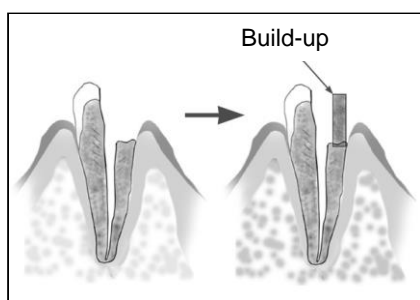

Broken crown

If the crown is broken and a section of the gingival tissue intrudes into the cavity surrounding the canal opening, contact between the gingival tissue and the file will result in electrical leakage and an accurate measurement cannot be obtained. In this case, build up the tooth with a suitable material to insulate the gingival tissue.

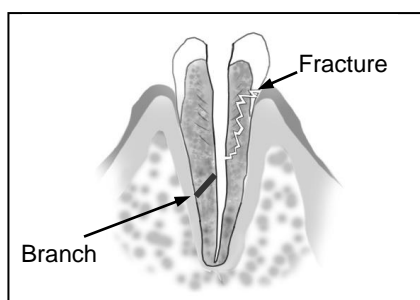

Fractured tooth

Leakage through a branch canal

Fractured tooth will cause electrical leakage and an accurate measurement cannot be obtained. A branch canal will also cause electrical leakage.

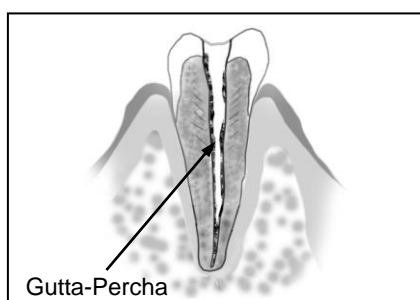

Re-treatment of a root filled with gutta-percha

The gutta percha must be completely removed to eliminate its insulating effect. After removing the gutta percha, pass a small file all the way through the apical foramen and then put a little saline in the canal but do not let it overflow the canal opening.

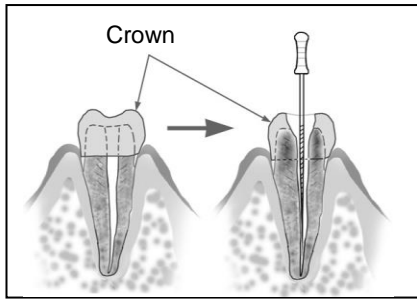

Crown or metal prosthesis touching gingival tissue

Accurate measurement cannot be obtained if the file touches a metal prosthesis that is touching gingival tissue. In this case, widen the opening at the top of the crown so that the file will not touch the metal prosthesis before taking a measurement.

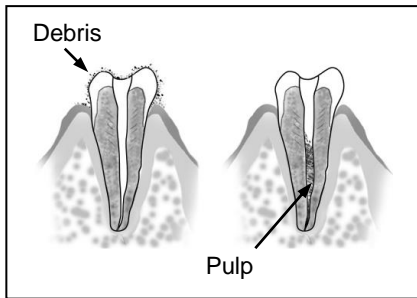

Cutting debris on tooth

Pulp inside canal

Thoroughly remove all cutting debris on the tooth. Thoroughly remove all the pulp inside the canal; otherwise an accurate measurement cannot be made.

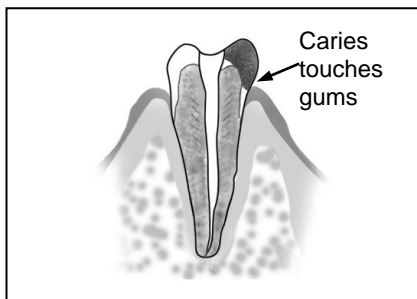

Caries touching the gums

In this case, electrical leakage through the caries infected area to the gums will make it impossible to make an accurate measurement.

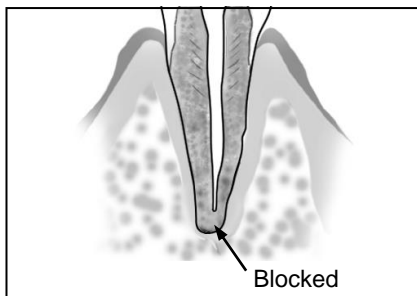

Blocked Canal

The meter will not move if the canal is blocked. Open the canal all the way to the apical constriction to measure it.

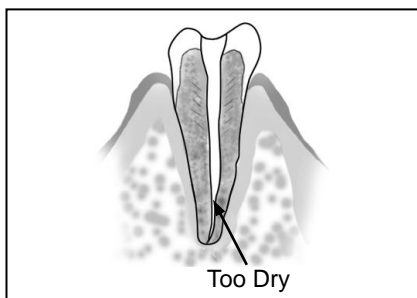

Extremely dry canal

If the canal is extremely dry, the meter may not move until it is quite close to the apex. In this case, try moistening the canal with oxydol or saline.

EMR and Radiography

Sometimes the EMR and the x-ray image do not correspond. This does not mean that the unit is not working properly or that the x-ray exposure is inaccurate.

* Frequently, the actual apical foramen and anatomical apex do not correspond exactly. The actual apical foramen may be located towards the crown. In this case, the x-ray image will seem to indicate that the file has not reached the apex.

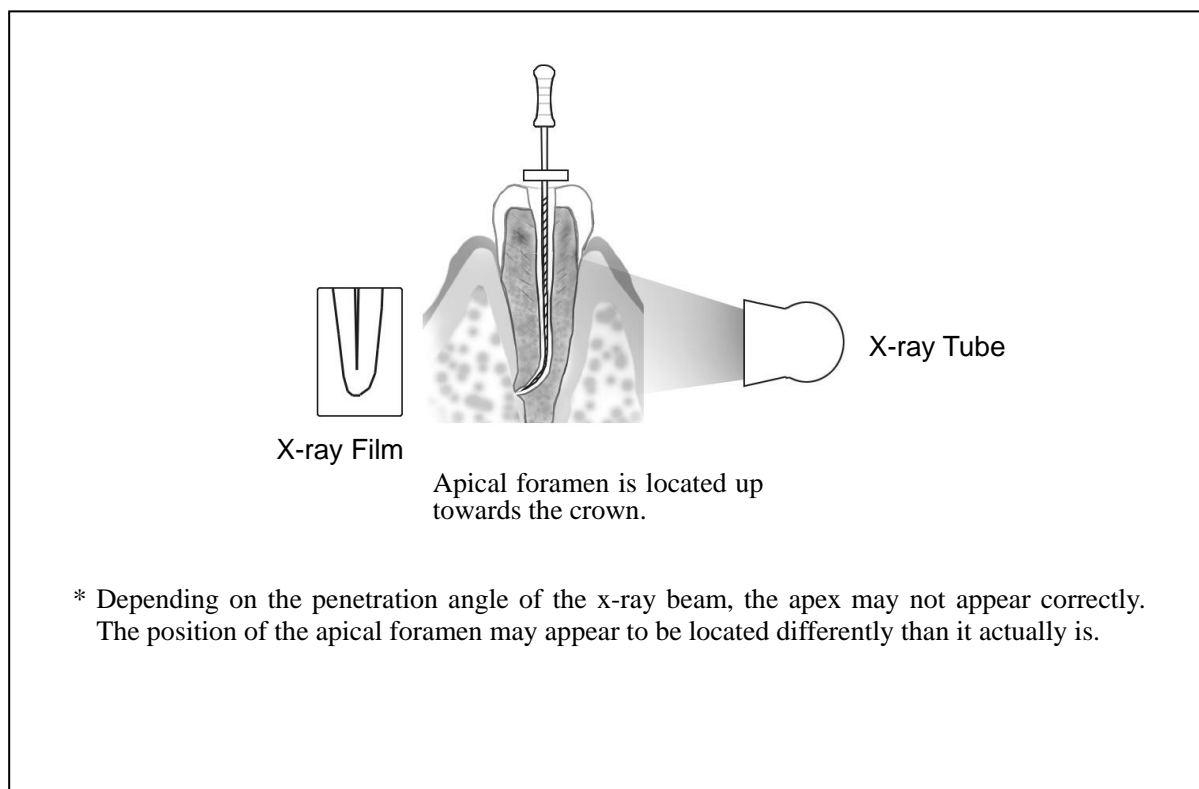

6. After Using the Unit

1. Turn off the unit.
 - * The unit will automatically turn off after 10 minutes of non-use.
2. Disconnect the probe cord from the unit and remove the file holder and contrary electrode from the probe cord.

⚠ CAUTION

- *When disconnecting and connecting the contrary electrode, probe cord and file holder, never pull or push on the cords themselves; always grip the connectors.*
- *Do not wrap the probe cord around the body of the main tube.*

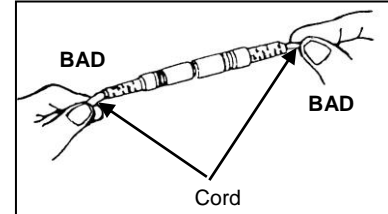

Replacing Batteries

Replace the batteries as soon as the battery power indicator starts flashing.

- * To be on the safe side, replace the batteries when the battery power indicator displays two lines.

⚠ WARNING

- *Do not use the unit if the battery power display is flashing. The unit may not function properly if the battery power is low.*

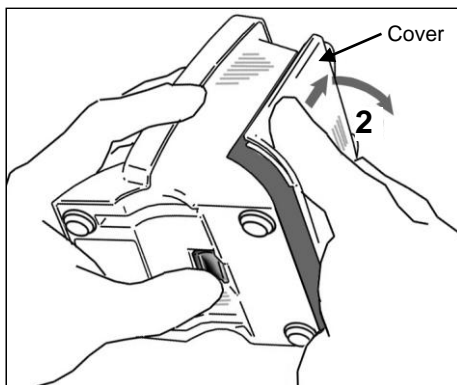
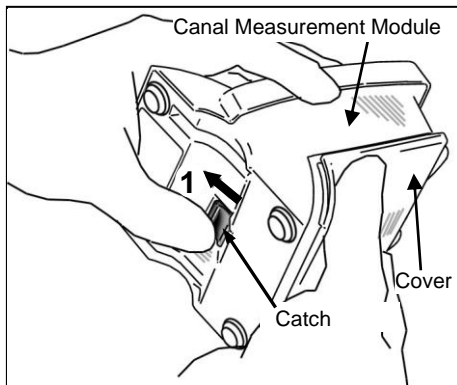

1. Hold the cover and slide the stopper on the bottom towards the liquid crystal display.
2. Slide the cover in the direction indicated by the arrow in the illustration and remove it from Canal Measurement Module.

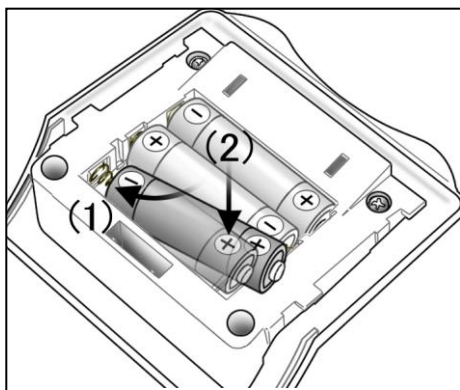

3. Take out the old batteries and replace them with new ones. Make sure the plus and minus poles are correctly lined up.

- (1) Insert the batteries by first pressing center of the minus end against its spring contact and then sliding the plus end down into place.
- (2) Make sure the contacts are not bent or damaged.



⚠ CAUTION

- *Do not reverse the plus and minus poles.*
- *Never allow the spring contact to push against the edge of the battery. This could damage the outer cover causing a short or a leakage of battery liquid.*

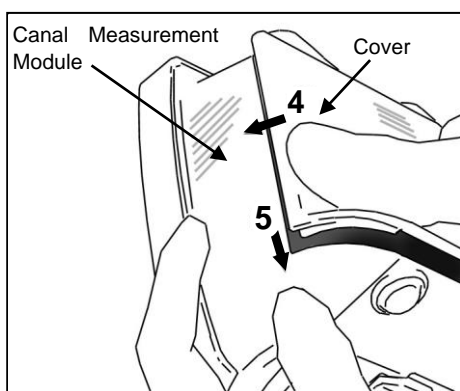

4. Line up the tabs on the cover with the notches on Canal Measurement Module and slide the cover on.
5. Slide the cover all the way down until it is securely attached.

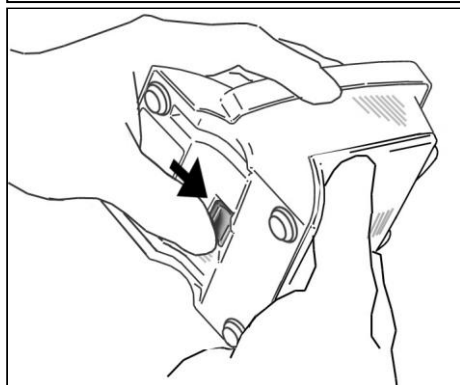
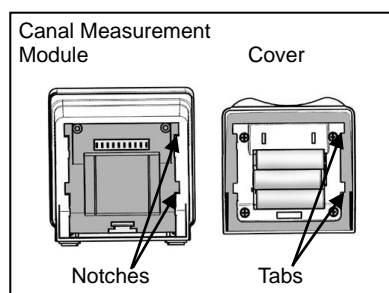

⚠ CAUTION

- *If the catch on the bottom is not back in its original place after attachment, push it in the direction shown by the arrow in the illustration.*
- *After installation, give the cover a light tug to confirm it is securely attached.*

⚠ CAUTION

- *Always use alkaline AA batteries.*
- *Never use rechargeable nickel-hydrogen or nickel-cadmium batteries.*
- *Replace all three batteries at the same time.*
- *Make sure that the plus and minus poles are correctly aligned.*
- *Never use batteries that are leaky, deformed, discolored or otherwise abnormal.*
- *Dispose of old batteries according to local codes and regulations.*
- *In case of battery leakage, carefully dry the battery terminals and remove all of the leaked liquid. Replace the battery with a new one.*

* Overheating could result if the above conditions are not adhered to.

* The three AA alkali dry cells used for this unit will last for about 100 hours of use. (This equals 6 to 12 months at normal rates of usage.)

7. Maintenance

There are 3 ways to clean and disinfect components depending on the component. Be sure to follow the procedure below when performing daily maintenance.

⚠ CAUTION

- *Be careful to avoid cross contamination when performing maintenance.*

Autoclavable Components

- Components maintained this way:

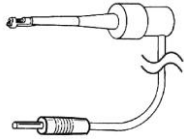

File Holder



Contrary Electrode



Long File Holder (option)

⚠ CAUTION

- *Take out the file before cleaning the file holder.*
- *Other than the components listed above, seer “Non-Autoclavable Components: Wipe with Ethanol” on page 23 for how to disinfect components.*

Procedure:



■ Cleaning

1. Disconnect the file holder (or long file holder) and contrary electrode from the probe cord.
2. Clean them off in running water with a soft brush and then wipe off the water.



⚠ CAUTION

- *If a medical agent being used for the treatment has adhered to the components, wash it off in running water.*
- *Do not clean the components with an ultrasonic cleaning device.*
- *After washing is complete, check to see if the file holder or long file holder, including its inside, is completely dry. If any water remains inside the component, expel it with an air gun or another such tool. Failure to do so could result in the remaining water coming out during use and cause malfunction or poor sterilization.*
- *If dust or other impurities adhere to the hook of the file holder or long file holder, they may cause malfunction.*

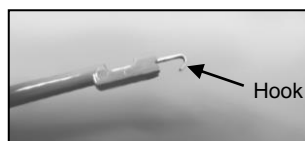

- *Do not use the high-temperature washer-disinfector.*

■ Disinfection

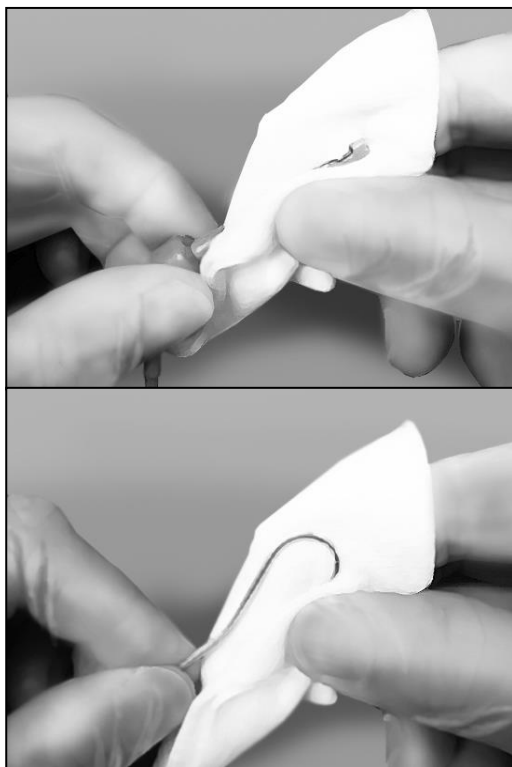

Wipe the file holder, long file holder and contrary electrode with a piece of gauze dampened with ethanol (70 vol% to 80 vol%).

⚠ CAUTION

- *Do not use anything except ethanol (70 vol% to 80 vol%).*
- *Do not immerse the components in or wipe it with any of the following: functional water (acidic electrolyzed water, strong alkaline solution, and ozone water), medical agents (glutaral, etc.), medicinal agents (glutaral, etc.), or any other special types of water or commercial cleaning liquids. Such liquids may result in plastic degradation, metal corrosion and adhesion of the residual medical agent to the components.*
- *Never clean the components with chemicals such as formalin cresol(FC) and sodium hypochlorite. These will damage the plastic parts of the components. If any of these liquids being applied to the components, wash it off in running water.*



Operating conditions for high-temperature washer-disinfectors

- * When using a high-temperature washer-disinfector to clean the components, strictly adhere to the conditions specified below.

High-temperature cleaning conditions

Unit Name	Mode	Detergent (concentration)	Neutralizer* (concentration)	Rinse (concentration)
Miele G7881	Vario TD	neodisher Mediclean (0.3% to 0.5%)	neodisher Z (0.1% to 0.2%)	neodisher Mielclear (0.02% to 0.04%)

* After cleaning, there may be streaks or white spots on the components. Use a neutralizer only if there are streaks or white spots.

Operating Precautions

- If any medical agent remains on the components, it may result in corroding the components.
- For details on handling medical agents or adjusting their concentration, refer to the user manual for the washing device.
- After washing is complete, check to see if the file holder, including its inside, is completely dry. If any water remains inside the component, expel it with an air blow gun or another such tool. Failure to do so could result in the remaining water coming out during use and cause malfunction or poor sterilization.

⚠ CAUTION

- *Inappropriate cleaning methods and solutions will damage the components.*
- *Do not clean the components using strong acidic or alkaline solutions that could cause the metal to corrode.*
- *Do not leave the components inside a high-temperature washer-disinfector.*

■ Packing

Individually place the file holder or long file holder, and contrary electrode in a sterilization pouch.

⚠ CAUTION

- *Do not put stress on the cable when you place the file holder in a sterilization pouch.*

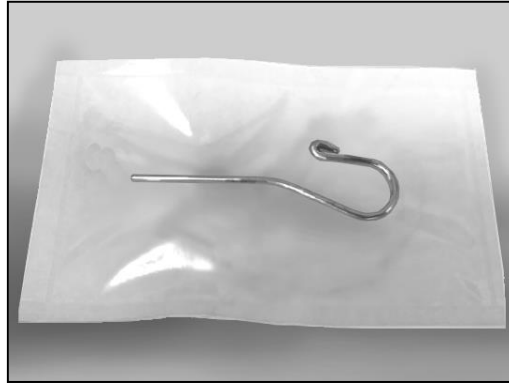
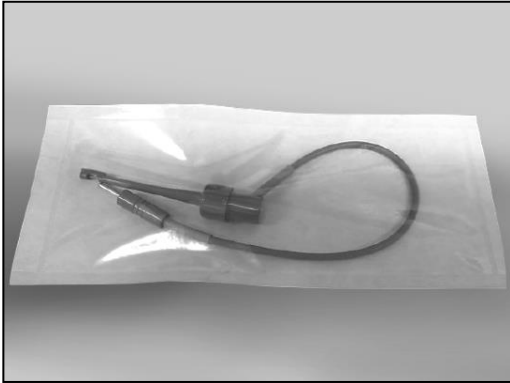

■ Sterilization



Autoclave the file holder, contrary electrode, and long file holder after use for each patient.

Recommended temperature and time:

+135°C (+275°F), 4 minutes minimum with a sterilization pouch.

Minimum drying time after sterilization: 10 minutes.

⚠ WARNING

- *To prevent the spread of infections, the file holder, long file holder, and contrary electrode must be autoclaved after each patient's treatment has been completed.*

⚠ CAUTION

- *The file holder, long file holder, and contrary electrode are extremely hot after autoclaving; do not touch until they cool off.*
- *Do not sterilize the components by any method other than autoclaving.*
- *Autoclaving and drying temperatures must never exceed +135°C (+275°F). Excess temperature could cause the contra angle to malfunction or could cause discoloration.*
- *Take the file out of the file holder or long file holder before autoclaving.*
- *Clean everything thoroughly before autoclaving. Any chemicals or foreign debris left on components could cause them to malfunction or could cause discoloration.*
- *Do not leave the file holder, long file holder, and contrary electrode in the autoclave.*
- *For sterilizing files, follow the manufacturer's recommendations.*

Non-Autoclavable Components: Wipe with Ethanol

- Components maintained this way:

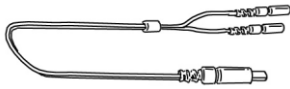

Probe Cord

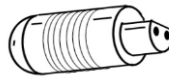

Tester

Procedure:

Disinfection

■ Disinfection

Wipe the components with a piece of gauze dampened with ethanol (70 vol% to 80 vol%).

⚠ CAUTION

- **Do not use anything except ethanol (70 vol% to 80 vol%). Do not use too much ethanol as it could seep inside and damage the components.**
- **Do not immerse the components in or wipe it with any of the following: functional water (acidic electrolyzed water, strong alkaline solution, and ozone water), medical agents (glutaral, etc.), medicinal agents (glutaral, etc.), or any other special types of water or commercial cleaning liquids. Such liquids may result in plastic degradation, metal corrosion and adhesion of the residual medical agent to the components.**
- **Never clean the components with chemicals such as formalin cresol (FC) and sodium hypochlorite. These will damage the plastic parts of the components. If any of these liquids being applied to the components, wash it off in running water.**

Non-Autoclavable Components: Wipe with Neutral Detergent and Moistened Cloth

- Components maintained this way:

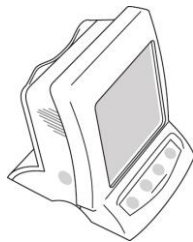

Canal Measurement Module

Procedure:

Cleaning

■ Cleaning

To clean the surfaces of the components, use a soft cloth to apply a little neutral detergent, and then rinse them with a cloth moistened with water.

⚠ CAUTION

- *Do not use excessive amounts of detergent or water and do not soak the components.*
- *Do not use paint thinner, benzine or similar solutions to clean the components.*
- *Avoid spilling chemical solutions used for treatment on the components. These chemicals could damage, deform or discolor the module. Use extra caution to avoid spilling formalin cresol (FC) and sodium hypochlorite as they are quite strong. Wipe up any chemical spills immediately (Some chemicals may leave traces even if wiped up immediately).*

8. Replacement Parts

- * Replace parts as necessary depending on degree of wear and length of use.
- * Order replacement parts from your local dealer or J. MORITA regional OFFICE.

9. Storage

- * Store the unit where it will not be exposed to x-rays or direct sunlight and where the ambient temperature range is between -10°C / $+14^{\circ}\text{F}$ and $+70^{\circ}\text{C}$ / $+158^{\circ}\text{F}$; humidity between 8% and 80 % (without condensation) and atmospheric pressure between 70 kPa and 106 kPa.
- * If the unit has not been used for a long time, make sure it works properly before using.
- * Always remove the batteries prior to storing or shipping the unit.
- * Working life: The working-life of this unit is 6 years from the date of shipment provided it is regularly and properly inspected and maintained.

10. Inspection

Regular Inspection

- * This unit should be inspected every 6 months in accordance with the following maintenance and inspection items.

Maintenance and Inspection Items

1. Check that the Power switch turns the unit on and off properly.
2. Insert the Tester and check that the indicator is within ± 3 lines of 1 on the meter.
3. Check that the Mode switch changes the memory from M1 to M2 to M3 etc.
4. Check that the Select and Set switches work properly.
5. Check that the probe cord can be properly plugged into its jack.
6. Check that the file holder's plug can be connected properly to the probe cord and that the file holder can be clipped onto a file. Check the contrary electrode can be plugged into its probe cord connector.

11. Troubleshooting

If the unit does not seem to be working properly, the user should first try to troubleshoot to solve operational problems. If the problems cannot be solved after referring to the list below, contact your local dealer or J. MORITA regional office.

Problem	Check Points	Response
No power	Check battery installation. Check battery power.	Install batteries properly. Replace batteries.
Cannot make a Measurement	Check cord connections. Check probe cord for broken wire.	Check that all connections are properly secured. Touch the contrary electrode to the file holder to check probe cord conductivity.
No sound	Check if sound is turned off.	Turn on the sound.
Cannot switch memories Cannot change memory settings	Is a measurement being performed? Does the switch work?	Switches do not work during measurement. Switch may be broken.
Display does not appear.	Is there a sound when the unit is turned on and off?	Replace batteries if there is no sound. Broken display if there is a sound.
Canal Length Indicator is unstable.	Is contrary electrode making good contact with oral mucosa? Is the file holder dirty?	Make sure the contrary electrode makes good contact with the oral mucosa. Clean the file holder with ethanol (70 vol% to 80 vol%).
Canal Length Indicator overreacts or is too sensitive. (Measurements are too short, poor accuracy or erratic results.)	Is blood or saliva overflowing from the opening of the crown? Is the root canal filled with blood, saliva or chemical solutions? Is the tooth surface covered with cutting debris or chemical solutions? Is the file touching the gingival tissue? Is there pulp tissue left inside the root canal? Is the file touching a metal prosthesis? Are proximal surfaces infected with caries? Are there lateral canals or is the tooth fractured? Does a broken crown allow leakage of electric current? Is there a lesion at the apex? Is the file holder broken or dirty?	If blood or other fluids overflow the canal, the current will leak to the gums and the meter will jump to Apex. Clean the canal, canal opening and tooth crown thoroughly. The canal length indicator bar may suddenly swing when it breaks the surface of fluids inside the root canal, but it will return to normal as it approaches the apex. Clean entire tooth surface. This will cause the canal length indicator bar to suddenly jump all the way to the "APEX". An accurate measurements cannot be obtained if a large amount of pulp tissue is left inside the root canal. Touching a metal prosthesis with the file allows a flow of current to the gingival tissue or periodontal pocket and will cause the meter to jump to the "APEX". Current can flow through the caries infected area to the gums and prevent an accurate measurement from being made. The canal length indicator bar may jump to "APEX" when it reaches the opening of a lateral root canal or the opening of a fractured tooth which allows the current to flow to the gingival tissue. Build up an insulating barrier to stop the leakage. A lesion can destroy the apical foramen through absorption and an accurate measurement cannot be obtained. Replace or clean the file holder.

Problem	Check Points	Response
Canal Length Indicator bar does not move (except when very near the apical foramen).	Is root canal blocked?	Canal length indicator will return to normal when the file reaches apical constriction.
	Is the apical foramen very large and open?	If the apical foramen is large or wide open and not completely formed, the canal length indicator bar will suddenly jump when the file tip gets close to the apex.
	Is root canal extremely dry?	Moisten the root canal with hydrogen peroxide or a saline solution.
	A small file in a large root canal.	Increase the size of the file.

Error Code



There may be something wrong with the instrument if any of the following error codes appear. If any of these appear repeatedly, contact your local dealer or J. MORITA Office for repairs.

Code*	Cause	Module	
		Measurement	Preparation and Light
F01	Defective canal measurement circuit	○	
F02	Defective off relay for the AC adapter		○
F03	Defective EEPROM	○	○
F04	Transmission Defect	○	○

*Error Code

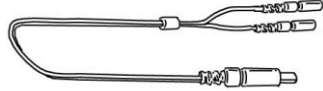
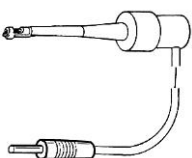

12. Replacement Parts List

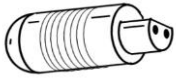
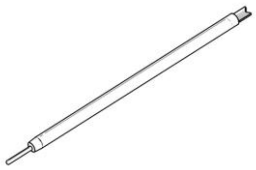
1		2		3	
4		5			

No.	Description
1	Probe Cord
2	File Holder (5)
3	Contrary Electrode (5)
4	Tester
5	Long File Holder (1)

13. Technical Specifications

Main unit and accessories

Model DP-ZX-VL

Type RCM-EX

Classification

Safety according to IEC 60601-1, IEC 60601-1-2, UL 60601-1, ISO 11498, ISO 7785-2, CAN/CSA C22.2 No.601.1-M90

European Directive 93/42/EEC IIa

Canada Medical devices Class II

Type of Protection against Electric Shock Battery operated

Degree of Protection against Electric Shock Type BF applied part

Degree of Protection against Ingress of Water IPX0

Mode of Operation Continuous

Intended use

It can be used to measure the length of the canal.

Main unit

Rated Voltage DC 4.5 V (with battery operation)

Rated Current max. 0.03 A (with battery operation)

Power Consumption 0.135 VA (with battery operation)

Dimensions Canal Measurement Module
115 ± 20(mm) x 105 ± 20(mm) x 105 ± 20(mm)

Weight Canal Measurement Module
Approximately 370 g

Operation, Transport and Storage Conditions for the main unit

Operating Conditions

Ambient temperature range +10°C / +50°F to +40°C / +104°F

Relative humidity 30% to 80% without condensation

Atmospheric pressure range 80 kPa to 106 kPa

Transport and Storage Conditions

Ambient temperature range -10°C / +14°F to +70°C / +158°F

Relative humidity 8% to 80% without condensation





















Atmospheric pressure range 70 kPa to 106 kPa

Applied part

Contrary Electrode, Probe Cord

Symbols

*Some symbols may not be used.

	Attention, consult accompanying documents.		Serial Number
	Unique device identifier		Medical device
	GS1 DataMatrix		Type BF applied part
	Manufacturer		Date of manufacture
	Direct current		Refer to instructions for use
	Autoclavable up to +135°C (+275°F)		Keep away from rain
	Fragile		This way up
	Temperature limitation		Atmospheric pressure limitation
	Humidity limitation		CE(0197) marking Conforms with the European Directive, 93/42/EEC. CE marking Conforms with the European Directive, 2011/65/EU.
	Marking of electrical equipment in accordance with the European Directive 2012/19/EU (WEEE)		EU Authorized Representative under the European Directive 93/42/EEC

Disposal

The package should be recycled. Metal parts of the device are disposed as scrap metal. Synthetic materials, electrical components, and printed circuit boards are disposed as electrical scrap. Material must be disposed according to the relevant national legal regulations. Consult specialized disposal companies for this purpose. Please inquire of the local city / community administrations concerning local disposal companies.

Service

ROOT ZX II may be repaired and serviced by

- the technicians of J. MORITA's subsidiaries all over the world.
- technicians employed by authorized J. MORITA dealers and specially trained by J. MORITA.
- independent technicians specially trained and authorized by J. MORITA.

Appendix- Electromagnetic declaration

Guidance and manufacturer's declaration – electromagnetic emissions		
The DP-ZX-VL is intended for use in the electromagnetic environment specified below. The customer or the user of the DP-ZX-VL should assure that it is used in such an environment.		
Emissions test	Compliance	Electromagnetic environment - guidance
RF emissions CISPR 11	Group 1	The DP-ZX-VL uses RF energy only for its internal function. Therefore, its RF emissions are very low and are not likely to cause any interference in nearby electronic equipment.
RF emissions CISPR 11	Class B	The DP-ZX-VL is suitable for use in all establishments, including domestic establishments and those directly connected to the public low-voltage power supply network that supplies buildings used for domestic purposes.
*Harmonic emissions IEC61000-3-2	Class A	
*Voltage fluctuations/flicker emissions IEC 61000-3-3	Complies	

*Indicates data when OTR Module is connected to Canal Measurement Module.

Guidance and manufacturer's declaration – electromagnetic immunity			
The DP-ZX-VL is intended for use in the electromagnetic environment specified below. The customer or the user of the DP-ZX-VL should assure that it is used in such an environment.			
Immunity test	IEC 60601 test level	Compliance level	Electromagnetic environment - guidance
Electrostatic discharge (ESD) IEC 61000-4-2	± 6 kV contact ± 8 kV air	$\pm 2, 4, 6$ kV contact $\pm 2, 4, 8$ kV air	Floors should be wood, concrete or ceramic tile. If floors are covered with synthetic material, the relative humidity should be at least 30 %.
*Electrical fast transients/bursts IEC 61000-4-4	± 2 kV for power supply lines ± 1 kV for input/output lines	± 2.0 kV for power supply lines ± 1.0 kV for input/output lines	Mains power quality should be that of a typical commercial or hospital environment.
*Surge IEC 61000-4-5	± 1 kV line(s) to line(s) ± 2 kV line(s) to earth	$\pm 0.5, 1$ kV line(s) to line(s) $\pm 0.5, 1, 2$ kV line(s) to earth	Mains power quality should be that of a typical commercial or hospital environment.
*Voltage dips, short interruptions and voltage variations on power supply lines IEC 61000-4-11	$< 5\% U_T$ ($> 95\%$ dip in U_T) for 0.5 cycle $40\% U_T$ (60% dip in U_T) for 5 cycles $70\% U_T$ (30% dip in U_T) for 25 cycles $< 5\% U_T$ ($> 95\%$ dip in U_T) for 5 sec	$0\% U_T$ ($> 95\%$ dip in U_T) /0.5 periods $40\% U_T$ (60% dip in U_T) /5 periods $70\% U_T$ (30% dip in U_T) /25 periods $0\% U_T$ /5 sec.	Mains power quality should be that of a typical commercial or hospital environment. If user of the DP-ZX-VL requires continued operation during power mains interruptions, it is recommended that the DP-ZX-VL be powered from an uninterruptible power supply or a battery.
Power frequency (50/60 Hz) magnetic field IEC 61000-4-8	3 A/m	3.15 A/m	Power frequency magnetic field should be at levels characteristic of a typical location in a typical commercial or hospital environment.
Note U_T is the a.c. mains voltage prior to application of the test level.			

*Indicates data when OTR Module is connected to Canal Measurement Module.

Guidance and manufacturer’s declaration – electromagnetic immunity			
The DP-ZX-VL is intended for use in the electromagnetic environment specified below. The customer or the user of the DP-ZX-VL should assure that it is used in such an environment.			
Immunity test	IEC 60601 test level	Compliance level	Electromagnetic environment - guidance
<p>Conducted RF IEC 61000-4-6</p> <p>Radiated RF IEC 61000-4-3</p>	<p>3 Vrms 150 kHz to 80 MHz</p> <p>3 V/m 80 MHz to 2.5 GHz</p>	<p>3 V</p> <p>3 V/m</p>	<p>Portable and mobile RF communications equipment should be used no closer to any part of the DP-ZX-VL, including cables, than the recommended separation distance calculated from the equation applicable to the frequency of the transmitter.</p> <p>Recommended separation distance</p> $d = 1.11 \sqrt{P}$ $d = 0.95 \sqrt{P} \quad 80 \text{ MHz to } 800 \text{ MHz}$ $d = 1.89 \sqrt{P} \quad 800\text{MHz to } 2.5 \text{ GHz}$ <p>Where <i>P</i> is the maximum output power rating of the transmitter in watts (W) according to the transmitter manufacturer and <i>d</i> is the recommended separation distance in meters (m). Field strengths from fixed RF transmitters, as determined by an electromagnetic site survey,^a should be less than the compliance level in each frequency range.^b Interference may occur in the vicinity of equipment marked with the following symbol:</p> 
NOTE 1: At 80 MHz and 800 MHz, the higher frequency range applies.			
NOTE 2: These guidelines may not apply in all situations. Electromagnetic propagation is affected by absorption and reflection from structures, objects and people.			
<p>^a Field strengths from fixed transmitters, such as base stations for radio (cellular/cordless) telephones and land mobile radios, amateur radio, AM and FM radio broadcast and TV broadcast cannot be predicted theoretically with accuracy. To assess the electromagnetic environment due to fixed RF transmitters, an electromagnetic site survey should be considered. If the measured field strength in the location in which the DP-ZX-VL is used exceeds the applicable RF compliance level above, the DP-ZX-VL should be observed to verify normal operation. If abnormal performance is observed, additional measures may be necessary, such as reorienting or relocating the DP-ZX-VL.</p> <p>^b Over the frequency range 150 kHz to 80MHz, field strengths should be less than 3 V/m.</p>			

Recommended separation distances between portable and mobile RF communications equipment and the DP-ZX-VL.

The DP-ZX-VL is intended for use in an electromagnetic environment in which radiated RF disturbances are controlled. The customer or the user of the DP-ZX-VL can help prevent electromagnetic interference by maintaining a minimum distance between portable and mobile RF communications equipment (transmitters) and the DP-ZX-VL as recommended below, according to the maximum output power of the communications equipment.

Rated maximum output power of transmitter W	Separation distance according to frequency of transmitter m		
	150 kHz to 80 MHz $d = 1.2 \sqrt{P}$	80 MHz to 800 MHz $d = 1.2 \sqrt{P}$	800 MHz to 2.5 GHz $d = 2.3 \sqrt{P}$
0.01	0.12	0.12	0.23
0.1	0.37	0.37	0.74
1	1.17	1.17	2.33
10	3.69	3.69	7.38
100	11.67	11.67	23.33

For transmitters rated at a maximum output power not listed above, the recommended separation distance d in meters (m) can be estimated using the equation applicable to the frequency of the transmitter, where P is the maximum output power rating of the transmitter in watts (W) according to the transmitter manufacturer.

NOTE 1: At 80 MHz and 800 MHz, the separation distance for the higher frequency range applies.

NOTE 2: These guidelines may not apply in all situations. Electromagnetic propagation is affected by absorption and reflection from structures, objects and people.

Essential Performance

Noise does not substantially change measurement.

Accessory

Probe Cord Code No.7503661

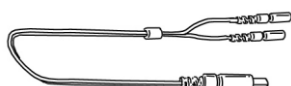

⚠ WARNING

- Use of the parts other than those accompanied or specified by J. MORITA MFG. CORP. may result in increased EMC emissions or decreased EMC immunity of the DP-ZX-VL.

14. Warranty

1 Year Limited Warranty

1. The manufacturer gives a worldwide guarantee for one year beginning from the date of purchase. Within this period any defect that is due to faulty manufacturer or material will be remedied by repair or replacement at the judgment of the manufacturer or its distributor.
2. Warranty repair and service: In the event of a claim under this guarantee, the device is to be sent to the service facility of the distributor, **postage and shipping paid**, including a short description of the problem, and a copy of the sales receipt from the dealer as proof of purchase and title to warranty. **Always ship prepaid. Distributor does not accept collect shipments.**
3. In the case of damage caused by wear and tear, careless handling and repairs not carried out by an authorized service facility, the warranty ceases to be valid. This guarantee may not form the basis for any claims for damages, in particular not for compensation of consequential damages.

The buyer assumes responsibility for damage due to dropping of the unit, improper use and utilization of product and chemicals other than those stated in this instruction manual for cleaning. It is the customer's responsibility to maintain the exact rated voltage indicated at the bottom of the unit, and the office maintains electrical outlets for proper performance of the unit.

4. **This warranty does not include the external accessories, file electrode, batteries, or transportation costs.**

ATTENTION

1. J. MORITA MFG. CORP. will not be responsible for accidents, equipment damage, or bodily injury resulting from repairs made by personnel not authorized by the J. MORITA MFG. CORP.
2. J. MORITA MFG. CORP. will not be responsible for accidents, equipment damage, or bodily injury resulting from any changes, modifications, or alterations of its products.
3. J. MORITA MFG. CORP. will not be responsible for accidents, equipment damage, or bodily injury resulting from the use of products or equipment made by other manufacturers, except for those procured by the J. MORITA MFG. CORP.
4. J. MORITA MFG. CORP. will not be responsible for accidents, equipment damage, or bodily injury resulting from maintenance or repairs using parts or components other than those specified by the J. MORITA MFG. CORP. and in their original condition.
5. J. MORITA MFG. CORP. will not be responsible for accidents, equipment damage, or bodily injury resulting from operating the equipment in ways other than the operating procedures described in this manual or resulting from not following the cautionary remarks and warnings in this manual.
6. J. MORITA MFG. CORP. will not be responsible for accidents, equipment damage, or bodily injury resulting from workplace conditions and environment or installation conditions such as improper electrical power supply which do not conform to those stated in this manual.
7. J. MORITA MFG. CORP. will not be responsible for accidents, equipment damage, or bodily injury resulting from fires, earthquakes, floods, lightning, natural disasters, or acts of God.
8. J. MORITA MFG. CORP. will supply replacement parts and be able to repair the product for a period of 10 years after the manufacture of the product has been discontinued.

- * Inspect the unit every 6 months in accordance with the Maintenance and Inspection items on page 21.
- * Refer to the parts replacement lists and replace worn parts whenever necessary.

Development and Manufacturing



J. MORITA MFG. CORP.

680 Higashihama Minami-cho, Fushimi-ku, Kyoto 612-8533, Japan
T +81. (0)75. 611 2141, F +81. (0)75. 622 4595

Morita Global Website www.morita.com

Distribution

J. MORITA CORP.

3-33-18 Tarumi-cho, Suita-shi, Osaka 564-8650, Japan
T +81. (0)6. 6380 1521, F +81. (0)6. 6380 0585

J. MORITA USA, INC.

9 Mason, Irvine CA 92618, USA
T +1. 949. 581 9600, F +1. 949. 581 8811

J. MORITA EUROPE GMBH

Justus-von-Liebig-Strasse 27b, 63128 Dietzenbach, Germany
T +49. (0)6074. 836 0, F +49. (0)6074. 836 299

MORITA DENTAL ASIA PTE. LTD.

150 Kampong Ampat #06-01A KA Centre, Singapore 368324
T +65. 6779. 4795, F +65. 6777. 2279

J. MORITA CORP. AUSTRALIA & NEW ZEALAND

Suite 2.05, 247 Coward Street, Mascot NSW 2020, Australia
T +61. (0)2. 9667 3555, F +61. (0)2. 9667 3577

J. MORITA CORP. MIDDLE EAST

4 Tag Al Roasaa, Apartment 902, Saba Pacha 21311 Alexandria, Egypt
T +20. (0)3. 58 222 94, F +20. (0)3. 58 222 96

J. MORITA CORP. INDIA

Filix Office No.908, L.B.S. Marg, Opp. Asian Paints, Bhandup (West), Mumbai 400078, India
T +91-22-2595-3482

J. MORITA MFG. CORP. INDONESIA

28F, DBS Bank Tower, Jl. Prof. Dr. Satrio Kav. 3-5, Jakarta 12940, Indonesia
T +62-21-2988-8332, F + 62-21-2988-8201

SIAMDENT CO., LTD.

71/10 Mu 5, Thakham, Bangpakong, Chachuengsao 24130, Thailand
T +66. 38. 573042, F +66. 38. 573043 www.siamdent.com