



TU101/G2(EX)-CE,01H. 2021.10. TO

# Operation Manual

## Model

Dental Treatment Unit

# SIGNO G10II

**CE**  
0123

Model TU101

Thank you for purchasing the SIGNO G10II.  
For optimum safety and performance, read this manual thoroughly before using the unit and pay close attention to the warnings and cautions.  
Keep this manual in a handy place for ready reference.

**J.MORITA TOKYO MFG.CORP.**

	page
Attention.....	4
[1] General Safety and Operation Instructions .....	5
[2] Parts Identification .....	6
[3] Installation .....	7
[4] Preliminary Adjustments and Connections .....	8
[5] Operation .....	10
1. Main Switch .....	12
2. Foot Control .....	13
3. Operator's Switch Panel .....	15
(1) Auto Positioning Switches .....	15
(2) Emergency Stop, Cancel and Safety Stop .....	16
(3) Set Switches .....	17
(4) Instrument Switches and Displays .....	18
(5) Chair Lock and HP Lock .....	21
(6) Instrument Switches and Displays (Swing Type) .....	23
(7) Menu Selection and User Settings (Swing Type) .....	26
4. Assistant's Switch Panel .....	30
5. Instrument Holder .....	31
6. Instruments .....	33
7. Basin Unit .....	41
8. Water Fountain .....	46
9. Operator's Tray .....	48
10. Film Viewer .....	54
11. Operating Light .....	55
12. Headrest .....	56
13. Armrest .....	57
14. Display .....	58
15. After use .....	59
16. Fuses .....	61

[6] Maintenance .....	62
Everyday Maintenance (before treatment) .....	63
1. Flushing Out the Water System .....	63
Everyday Maintenance (between patients) .....	67
1. Vacuum System Rinsing .....	67
Everyday Maintenance (after use) .....	68
1. Cleaning the Cut Filters .....	68
2. Cleaning the Basin .....	69
3. Rinsing the vacuum piping with cleanser .....	70
Maintenance as Required .....	71
1. Cleaning Other Components and Surfaces .....	71
2. Other Components and Surfaces .....	71
Wiping with Disinfectant Ethanol .....	72
1. Wiping the Parts .....	72
2. Wiping procedure .....	73
3. Instrument Wiping .....	73
4. Leather Seat and Backrest Surfaces .....	73
Autoclave Sterilization .....	74
1. Sterilization the parts .....	74
2. Sterilization procedure .....	74
3. Instrument Sterilization .....	75
4. Other Sterilization .....	75
Other Methods of Disinfection and Sterilization .....	76
Once a Month .....	77
1. Vacuum Tank Inspection and Cleaning .....	77
2. Clean the Drain Trap .....	79
3. Inspect and Clean the Oil Drain Filter .....	81
4. Clean and Dismantle of Vacuum Syringe / Saliva Ejector .....	82
Once a Year .....	83
1. Replacing the Bacteria Cartridges .....	83
[7] Inspection .....	86
[8] Troubleshooting .....	91
[9] Warranty and Repairs .....	92
[10] Disposal of Medical Devices and Equipment .....	92
[11] Specifications .....	93
[12] EMC Technical Description .....	95

## Attention:

1. CE Labelin  
CE-Symbol of conformity. This symbol of conformity guarantees that this appliance conforms to the relevant safety guidelines of the European Union.
2. Guidelines  
This appliance conforms to the following safety guidelines: Medical device guidelines 93/42/EEC, with amendments.
3. The manufacturer will not be responsible for accidents, equipment damage, or bodily injury resulting from the conditions and actions specified below:
  1. Repairs, maintenance, modifications, handling, or installation performed by personnel not authorized by the manufacturer.
  2. Use of parts or components other than those specified by the manufacturer and in their original condition.
  3. Repairs, maintenance, modifications etc. using supplementary components other than those specified by the manufacturer and in their original condition.
  4. Operating the equipment in ways other than the operating procedures described in this manual or resulting from not following the cautionary remarks and warnings in this manual.
  5. Workplace conditions and environment or installation conditions which do not conform to those stated in this manual.
  6. Fires, earthquakes, floods, lightning, natural disasters, or acts of God.
4. The operation and maintenance of medical devices is the responsibility of the user (hospital, clinic, laboratory etc.). This equipment must not be operated by any individual except doctors and dental technicians who are legally qualified to do so.
5. This equipment is accompanied by a warranty. The warranty must be filled out with the date of purchase, purchaser's name (hospital, clinic, laboratory etc.), address, postal code, telephone number, and the dealer's name and signed by the purchaser. The dealer should receive a copy of the warranty and the purchaser should keep and carefully save the original.











The following items are indicated on the label attached to the equipment:  
Product Name, Model, Ser. No., Lot No., Manufacturer's Address, Voltage, Power, Frequency

# [1] General Safety and Operation Instructions

## 1. Safety Symbols and Indicators



This manual uses a system of safety symbols to promote and insure safe operation and prevent injuries, accidents and damage.

- (1) Learn to recognize and understand the meaning of the various symbols shown below.
- (2) After reading this manual, keep it in a handy place for ready reference.
- (3) Follow all safety instructions without exception.



SAFETY SYMBOLS CHART	
 <b>WARNING</b>	This indicates the possibility of serious bodily injury or death and serious damage if the safety instructions are not followed.
 <b>CAUTION</b>	This indicates the possibility of minor bodily injury or damage if the safety instructions are not followed.
Symbols	 This symbol indicates a WARNING or CAUTION instruction.
	 This symbol indicates an operation or procedure which MUST NOT be performed.
	 This symbol indicates an instruction which MUST BE followed.
	 This symbol indicates a warning for high temperatures which MUST BE followed.
	 This symbol indicates an instruction a pay attention to dangerous voltage.
	 This symbol indicates the B type cavity that MUST BE followed.
	 This symbol indicates an instruction Main Switch(ON).
	 This symbol indicates an instruction Main Switch(OFF).
	 This symbol indicates that reference to the operation manual is needed.

## 2. Operation Advice and Hints

Certain key points concerning operation are indicated by the symbols shown in the chart to the right. These are points to help the operator use the equipment more easily.

Advize Hints Symbols Chart	
 <b>ADVICE</b>	Indicates advice concerning operation.
 <b>CHECK</b>	Indicates points which should be check during operation.

## 3. Operational Purpose of Equipment

 <b>WARNING</b>	
	<b>SIGNO G10-2 is a dental treatment unit and must not be used for any other purpose.</b> >>Use for any purpose not designated is dangerous and could result in accidents or damage to the equipment.

## [2] Parts Identification

### <Main Unit>

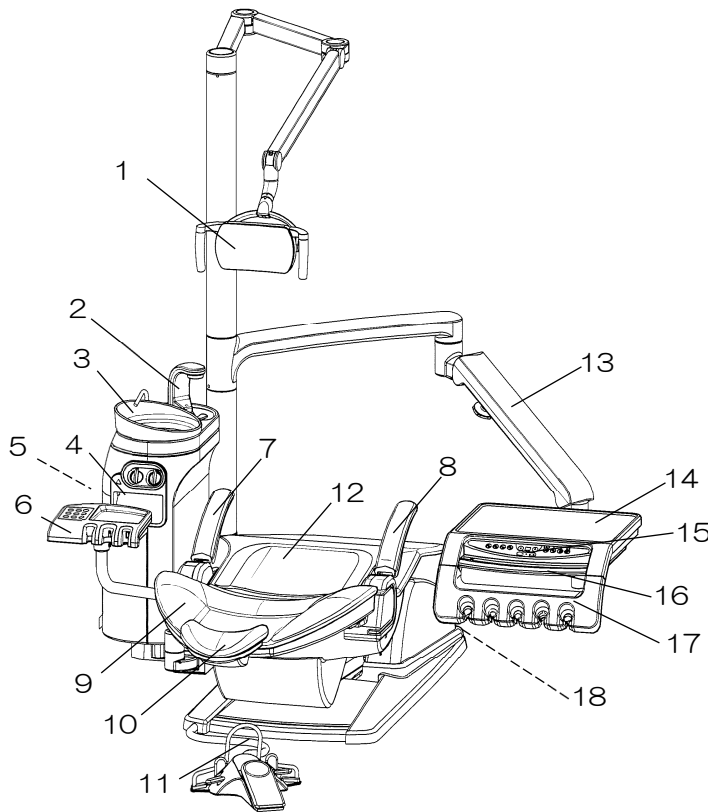

No	Parts
1	Operating Light
2	Auto Filler
3	Basin
4	Basin Unit
5	Water Snap-on Connector
6	Assistant's Instrument Holder
7	Assistant's side Arm Rest *
8	Operator's Side Arm Rest *
9	Backrest
10	Headrest
11	Foot Switch
12	Seat
13	Tray Arm
14	Operator's Tray
15	Operator's Switch Panel
16	Tray Handle
17	Operator's Instrument Holder
18	Main Switch

\* : Option

### <Main Options>

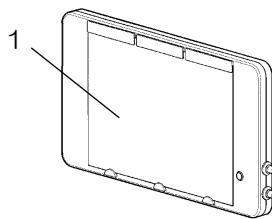



No	Parts
1	Triple Film Viewer

### <Accessories>

1) Tray Paper	: 1Package	7) Exclusive cleaner	: 1
2) Paper Cups	: 1Package	8) Operation Manual	: 1
3) Star Caps for Paper Cups	: 1Package	9) Installation Manual	: 1
4) Waste Container Stand	: 1	10) Warranty	: 1
5) Head Rest Cove	: 1	Also parts and components for the instruments selected.	
6) Extra Fuses	: 1set		

[3] Installation

 **WARNING**

	<p><b>The equipment must be installed by a qualified and trained professional specified by J.Morita Corp. according to the conditions specified in the Installation Standards Manual.</b>                  &gt;&gt;Otherwise, there is the danger of an accident or equipment damage.</p>
	<p><b>The unit must be fastened and fixed to the floor securely as specified in the installation manual.</b>                  &gt;&gt;Otherwise, the chair could fall over resulting in injury or damage.</p>
	<p><b>The equipment MUST NEVER be connected to an electrical supply source which is not the specified voltage, current, frequency and power. Each unit must have its own devoted electrical circuit connection and should not share a circuit with other units or other types of equipment.</b>                  &gt;&gt;Otherwise, there is the danger of shorts or over heating resulting in injury or damage.</p>
	<p><b>Never splash the equipment with water or place it in an area where it could get wet.</b>                  &gt;&gt;This would create the danger of shorts or overheating resulting in injury or damage.</p>
	<p><b>Do not install the unit in an area where chemicals are stored or where gas could be released.</b>                  &gt;&gt;This would create the danger of fire or electrical shock resulting in injury or damage.</p>
	<p><b>Do not route the power supply cord, the earth lead or the foot control cord through areas such as doorways and halls where they could be damaged.</b>                  &gt;&gt; This would create the danger of shorts and electrical shocks resulting in injury or damage.</p>

 **CAUTION**

	<p><b>Do not tilt the equipment or place it in an unstable position; do not expose it to excessive vibration of physical bumps or shocks.</b>                  &gt;&gt; This could cause it to malfunction or damage it.</p>
	<p><b>Do not install the equipment in areas where it will be exposed to excessive atmospheric pressure, humidity, temperatures, wind, direct sunlight, dust, salts or sulfur compounds.</b>                  &gt;&gt; Any of the above conditions could cause the equipment to malfunction or damage it.</p>
	<p><b>SIGNO G10 must be installed in a room appropriate for dental treatment.</b>                  1)Temperature: 10~40°C                  2)Humidity:30~75%RH(without condensation)                  3)Pressure:700~1060hPa                  &gt;&gt; Otherwise it may fail to perform optimally, and it could malfunction as well.</p>

## [4] Preliminary Adjustments and Connections

### 1. Various Adjustments and Settings

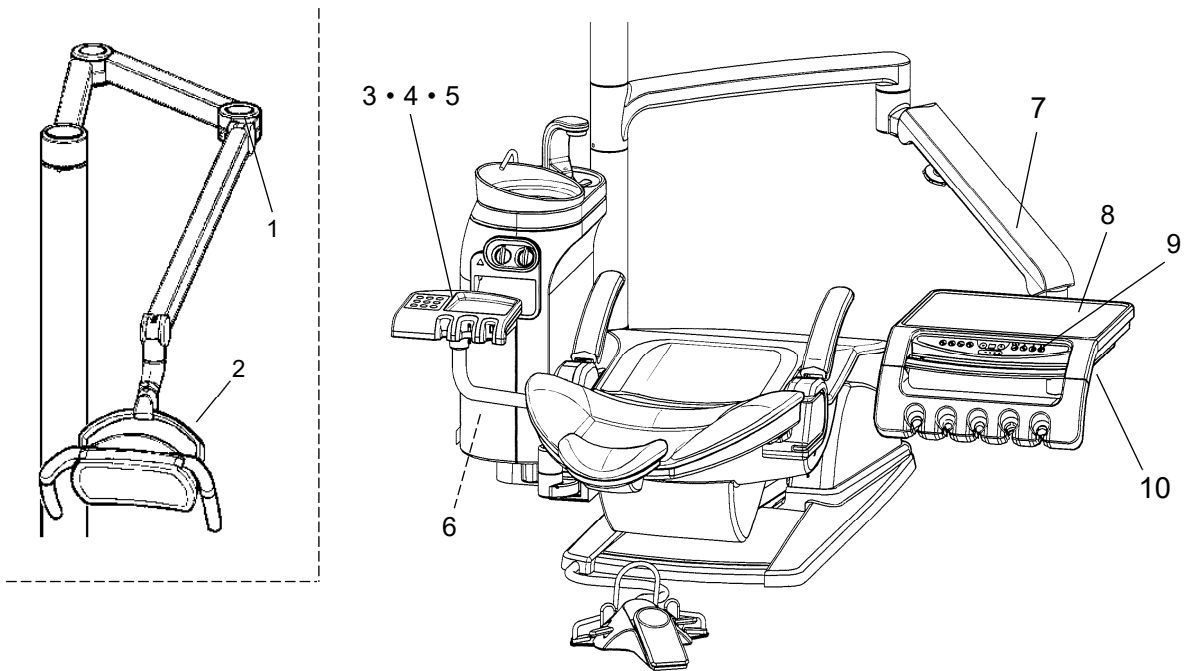

The items in the diagrams and chart below can be adjusted in various ways. To adjust an item, refer to the chart and then consult the part of the Operation section (5. Operation) of this manual noted there or the installation manual. Contact your local dealer or J.Morita Corp. concerning any points that are not clear, or items not appearing in the diagrams and chart below.



No.	Item	Reference	No.	Item	Reference
1	Light Arm Movement	Installation Manual	7	Tray Arm Motion	9(1)
2	Light Movement	Installation Manual	8	Operator's Tray Arm Angle	Installation Manual
3	Auto Filler Water Volume	8(1)	9	Auto Position	3(1)
4	Warmer Temperature	7(2)	10	Instrument Air and Spray Volume	6(10)
5	Water Volume for Snap-on Connection	7(3)			
6	Three-way Syringe Tube Heater Temperature	6(4)			



## 2. Instrument Connections

 CAUTION	
	<p><b>Before using the equipment, connect all the instrument main tubes. The three-way syringes should also be connected.</b></p> <p>&gt;&gt;Otherwise, air or water could leak.</p>
	<p><b>All instruments must be in their specified holders except when in use.</b></p> <p>&gt;&gt;Otherwise, an injury or damage could result from using the vacuum syringe or some other instrument.</p>

Connect the main tubes for the operator's instruments to their tray and those for the assistant to the assistant's tray. Then put all the instruments in their specified holders. Refer to the instructions below.



>> Main Tube Connections: Attached installation manual.

Three-way Syringe Body and Nozzle Attachment: Section [5] 6. (4) to [5]6. (6) of this manual

>> Vacuum Syringe and Saliva Ejector: Section [5] 6. (7) and (8) of this manual

>> Various Instruments: Individual operator's manuals for each instrument

## 3. Install the Filters

 CAUTION	
	<p><b>All the filters must be installed before using the equipment.</b></p> <p>&gt;&gt;If the filters and their covers are not properly installed, the equipment may not perform satisfactorily or could be damaged. Also water, air or vacuum lines could become plugged up.</p>

Filters:	
1	Vacuum Cut Filter
2	Basin Filter
3	Drain Trap Filter
4	Oil Drain Filter
5	Water Bacteria Cartridge *
6	Air Bacteria Cartridge *





The chart shows the various filters which are required and supplied with the equipment.

Refer to Section [6] Maintenance of this manual for installation instructions.

\* : Option

[5] Operation

 **WARNING**

	<p><b>Do not place any objects below or near moving parts such as the seat and backrest or within the range of their movement. Keep hands, fingers and feet clear of all moving parts.</b> (See “Illustrated Guide to Cautionary Points”)                  &gt;&gt; Otherwise, fingers or other body parts could be pinched resulting in injury or damage.</p>
	<p><b>Do not place heavy objects, sit or exert excessive force on the edges of the seat, backrest, headrest, light or tray. Never stand on, climb on or jump on or off the equipment.</b>                  &gt;&gt; These actions could cause the equipment to fall over resulting in injury or damage.</p>
	<p><b>Do not spill fluids or place flammable or metal objects inside the equipment.</b>                  &gt;&gt; This could result in injury or damage due to fire, electrical shock or other accidents.</p>
	<p><b>Avoid accidents that could result in bodily injury or equipment damage by paying attention to the points listed below:</b>                  1) Make sure the equipment is only used by specified and qualified operators. Do not allow anyone to operate the equipment randomly or play with it.                  2) Keep an eye on the patient at all times.                  3) Do not let patients assume risky positions (legs sticking out, standing on seat, sitting with their legs folded under them etc.)                  4) Do not require patients to sit or move in stressful ways. (E.g., sudden headrest movement if patient has a sore neck or lying face up if patient has a sore lower back etc.)                  5) Keep fingers and other parts of the body, bags and other personal belongings clear of moving parts and the areas in which these parts move (e.g., joints in tray arm, backrest etc.)                  6) Only one person at a time should occupy the seat; do not allow children to sit with their parents during treatment.                  7) Do not allow people especially children to loiter or play near the chair.                  8) Do not allow the light, tray, or other parts of the equipment to lean on or make contact with walls, windows, cabinets or other equipment and objects. (Avoid hitting things etc.)                  9) Avoid any other actions which seem dangerous.                  10) Avoid any other conditions which seem dangerous.                  &gt;&gt; Not paying sufficient attention to the above points could result in injury or damage.</p>
	<p><b>If the danger of injury or accident suddenly arises in the midst of auto positioning, stop the chair immediately using any one of the emergency stop procedures listed below:</b>                  A Step on the foot pedal.                  B Operate any of the manual positioning levers on the foot control. (Seat or backrest, up or down, will all stop the chair.)                  C Turn the main switch off.                  &gt;&gt; Not taking timely action to stop the chair could result in injury or damage.</p>
	<p style="text-align: center;"> <b>CAUTION</b></p>
	<p><b>If a patient uses a pacemaker, do not use the ultrasonic scaler and electrocautery scalpel at the same time.</b>                  &gt;&gt; There is a risk of health problems due to malfunction of the pacemaker.</p>
	<p><b>Do not use pointed tools to push the various panel switches or scratch the surface covering of the switches.</b>                  &gt;&gt; Doing so could cause a malfunction or lead to abnormal operation.</p>

## ◆ Illustrated Guide to Cautionary Points

Always make sure it is safe before moving the chair manually or with auto positioning. Especially pay attention to the points noted in the illustration below so that the patient or other equipment is not hit or pinched etc.



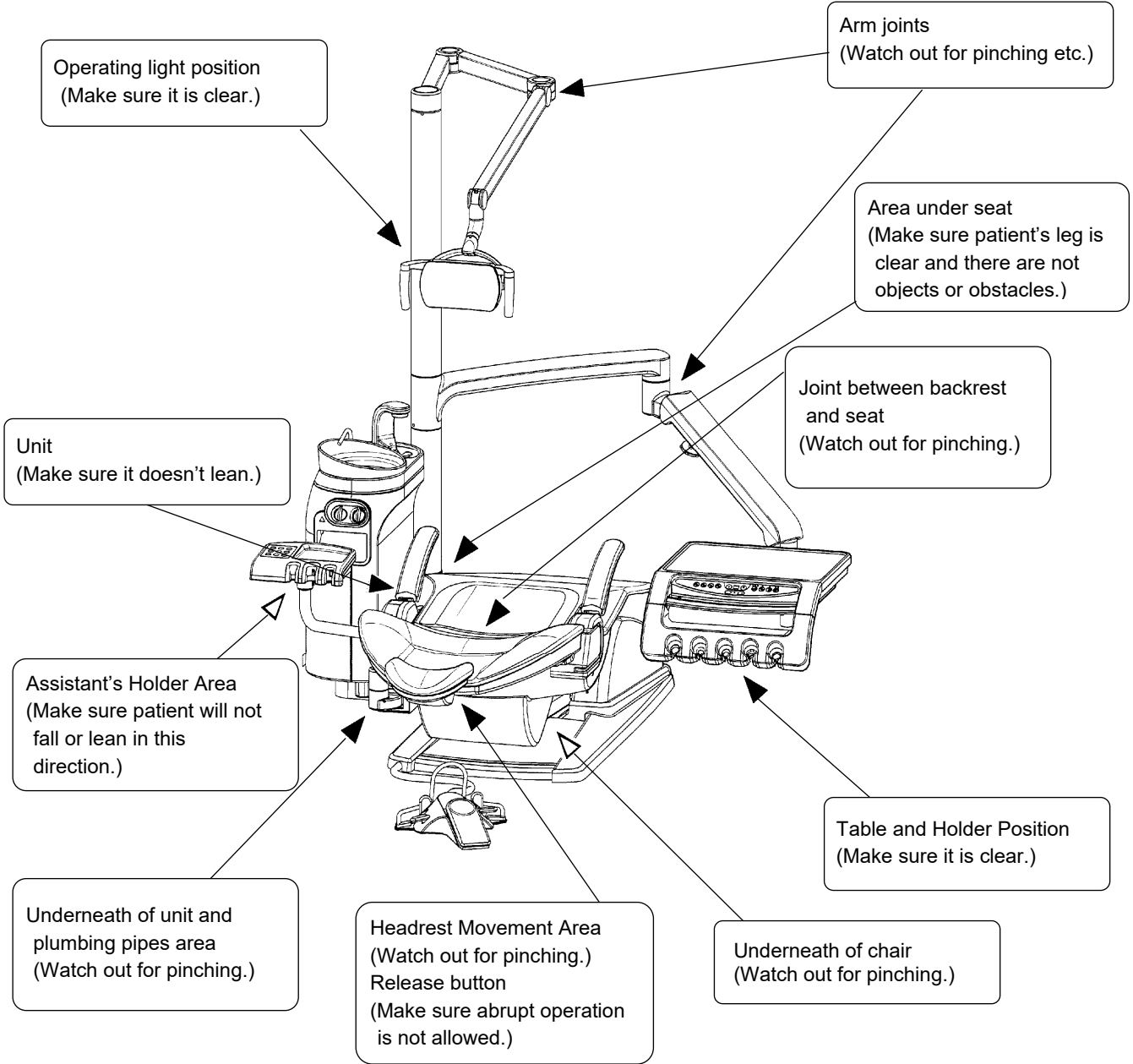

▲ : Watch out for moving or rotating parts etc.  
 △ : Indicates an emergency stop is required



Seat  
 (Make sure abrupt operation is not allowed.)



## 1. Main Switch

 CAUTION	
	<p><b>Never bump or bang the equipment or expose it to excessive vibration while the main switch is on.</b></p> <p>&gt;&gt; This could cause an accident resulting in injury or damage.</p>
	<p><b>Always turn the main switch off after treatment, during breaks in treatment or whenever the unit is not in actual use.</b></p> <p>&gt;&gt; Otherwise, there could be an accident resulting in injury or damage.</p>
	<p><b>Turn the main switch off before using an electric scalpel in the immediate vicinity of the equipment. Or, please refrain from using equipment that causes the electromagnetic waves such as cellular phones.</b></p> <p>&gt;&gt; Otherwise, electromagnetic waves emitted by the electric scalpel could cause the equipment to operate in a random or abnormal way resulting in an accident causing injury or damage.</p>

### (1) Operation

The main switch is located on the lower part of the motor cover. Turn it on to turn the unit on. The lamp on the side of it lights up when it is turned on and all the instruments etc. can then be operated.

Turn it off to turn the unit off. The lamp goes out when it is turned off.

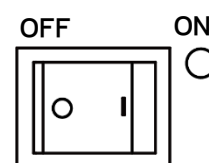

**Main Switch**  
(Green lamp lights up when on.)

### (2) Save Power Function

For both safety and economy, the unit automatically goes into the save power mode if it has not been used for the set period of time. (At shipment setting will be 120 minutes)

>> The operating light goes out. (When equipped with auto light\*)

>> The operating light and its indicator go out.

>> The power for chair operation and the gas burner\* is turned off.

>> The water is turned off.

When in save power mode, normal operation can be restored by pressing any of the operator's or assistant's operation switches, stepping of the foot pedal or picking up an instrument\*\*.

The save power mode can be turned off. Please contact your local dealer or the Morita Corp. for the change (60 or 120 minutes).

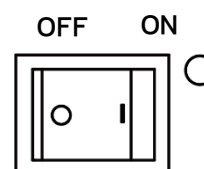

**Main Switch**  
(The lamp goes out during save power mode)

\*\* : Only corresponded for each circuits with foot control (Air turbine/Micromotor/Ultrasonic scaler)

Equipment Symbols  
\* : Option

## 2. Foot Control

<b>⚠ CAUTION</b>	
<b>⊘</b>	<p><b>Please do not assume any dangerous positions when riding on the foot control, foot pedal or operation levers.</b></p> <p>&gt;&gt;Not paying sufficient attention to the above points could result in injury or damage. Once the foot control gets wet, do not use the same place again while it is still wet.</p>
	<p><b>Please restart use after moisture has been wiped off with the main switch turned off, and after it has dried naturally.</b></p> <p>&gt;&gt;Not observing the above could result in injury, damage, electric shock or other accidents.</p>
	<p><b>Never place a load greater than 10N (1kgf) on the foot control, foot pedal or operation levers.</b></p> <p>&gt;&gt;Doing so could cause a malfunction or load to abnormal operation.</p>
	<p><b>Please do not place the foot control on an incline or upside down.</b></p> <p>&gt;&gt;Doing so could cause a malfunction or load to abnormal operation.</p>

### (1) Manual Chair Operation Levers

#### 1) Operation

Use these levers to raise or lower the backrest and seat.  
The chair moves only while one of the levers is actually being pressed. The seat and backrest will stop automatically if they reach their upper or lower limits. Release the lever when this happens.

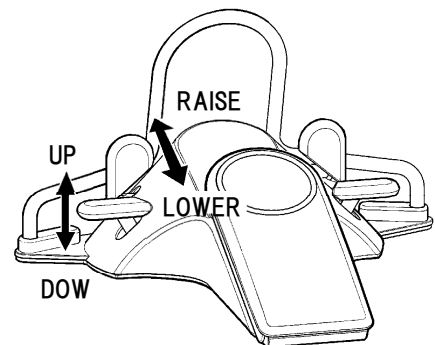

#### 2) Lowest Seat Height

The seat normally goes down to a height of 450mm, but it can be lowered to 400mm in the following seat lever operation.

- a) Press the seat lever for the down direction until the seat automatically stops at a height of 450mm.
- b) Release the seat lever and then press it again to lower it to 400mm.

#### **ADVICE**

The position where the lowering seat stops automatically depends on the setting of the R(Reset) switch. (See[5]3.(1) in this manual.) If the R (Reset) switch is set at the lowest height, the lowering seat does not stop automatically on its way to the lowest height.

## (2) Foot Pedal

### 1) Instrument Operation

Use this pedal to operate the operator's instruments.  
Step on the pedal to operate whichever instrument has been selected. A safety circuit prevents the chair from moving whenever the foot pedal is being used.

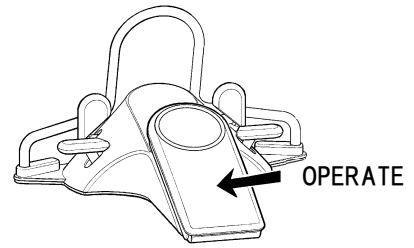

## (3) Extended Function Levers \*

The functions of these levers depend on whether an instrument has been picked up or not. Each lever has 4 possible functions.

### 1) Chair Auto Positioning \*\*

If all instruments are put away, the levers can be used for auto positioning. (See illustration to the right.)  
For details see section [5]3. (1) in this manual.

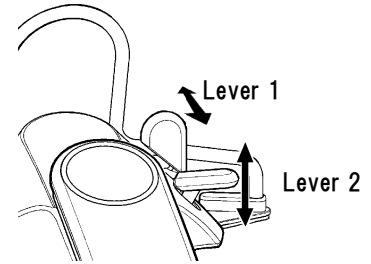

### ADVICE

The lever must be held for at least 1 second before the chair starts to move. This is to prevent accidental activation.

### 2) Instrument Settings \*\*

If an instrument has been picked up, these levers can be used to make various adjustments. (See illustration to the right.)  
For details, see section [5]3.(4) in this manual.

Contents of extended functions lever is changeable. (Partly it may be restricted due to the situation.)  
Please contact your local dealer or J.Morita Corp. for the change.

\*\* : Some functions may not be possible depending on the combination of various options.

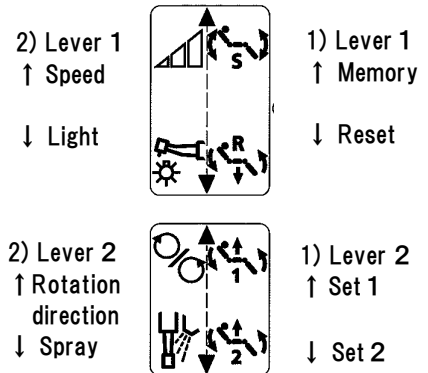

\* : Option

## 3. Operator's Switch Panel

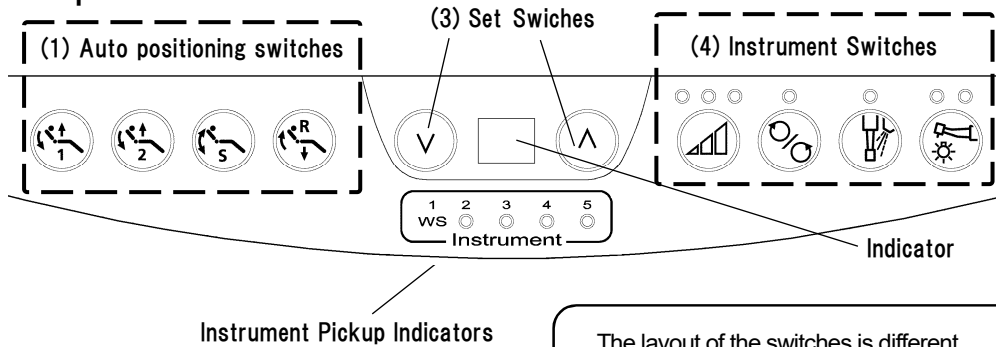

The layout of the switches is different in the case of the swing type. (The functions and basic operations of the switches are the same as for the switches on the standard panel.)  
For details of the functions provided only for the swing type, refer to (6) in this section.

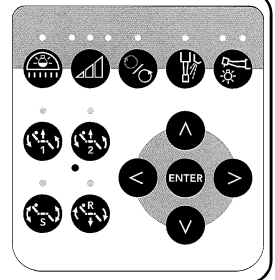

### (1) Auto Positioning Switches

These switches are used to raise and lower the seat and backrest.  
The seat and backrest automatically move into one of the preset positions when one of these switches is pressed once.

#### 1) Treatment Positions 1 and 2

These are usually used for treatment.  
The chair moves into the preset position when the switch is pressed. These positions can be adjusted.

#### <Setting the Treatment Positions>

- Use the levers on the foot control to put the chair in the desired position.
- Hold down the switch that corresponds to this position (1 or 2) for 5 seconds.
- Keep holding the switch down until a beep indicates that the position has been memorized.

#### < Auto positioning switches >

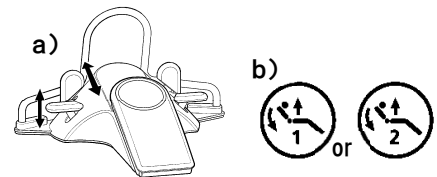
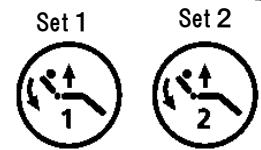
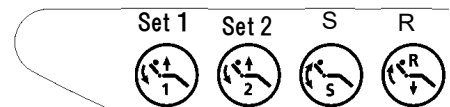

#### 2) S (Rinse /Memory)

This is used when the patient needs to rinse with his/her mouth, and the chair returns back to any treatment position.

The chair temporarily memorizes its present position and automatically returns back when the patient has finished rinse his/her mouth.



#### 3) R(Reset)

This is used before and after treatment.

Seat goes down to its lowest position and backrest moves forward at a maximum. Only seat height can be adjusted in the same way as 1) above.



## (2) Emergency Stop, Cancel and Safety Stop for Auto Positioning

Use the procedures listed below to stop the chair in the midst of auto positioning.

In the case of a Safety Stop, the chair stops automatically.

### 1) Emergency Stop

Use this in the case of an imminent danger.

It will stop instantly by using either of the following methods:

- (A) Step on the foot pedal
- (B) Turn off the main switch

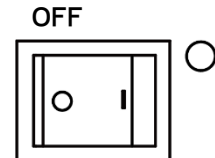
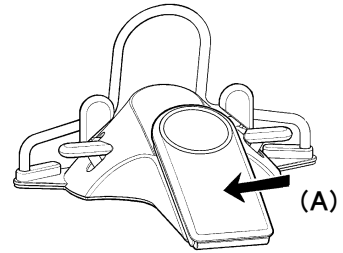

- (B) Main Switch  
(Green lamp lights up when on)
- (A) Auto positioning switches

### 2) Cancel

Use this to stop the chair during auto positioning. Use one of the following methods:

- (A) Press any of the auto positioning switches on either the operator or assistant side.
- (B) Operate any of the manual positioning levers on the foot control.  
(Seat or backrest, up or down, will all stop the chair.)

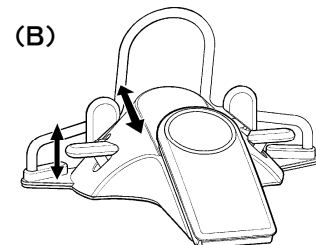
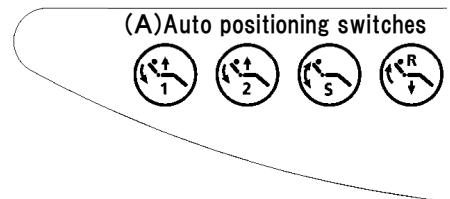



### 3) Safety Stop

Auto positioning will stop if something presses up the assistant's instrument holder (A), and presses on the base cover (B).

**CHECK**

After checking the appropriate areas and removing any obstacles, resume normal operation.

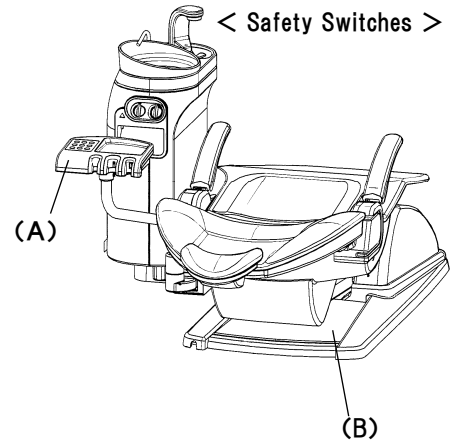

### (3) Set Switches

The set switches are used in combination with various changeover switches (see following (4) section) to change settings and values. Values or settings are shown in the display.

See the following section for specific applications.

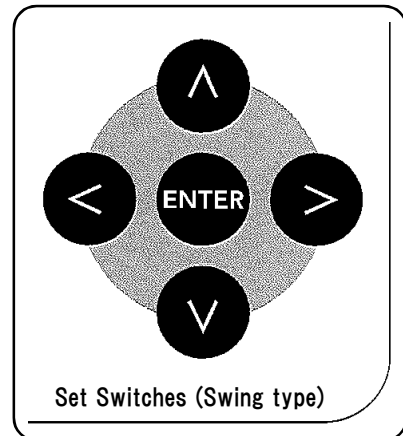
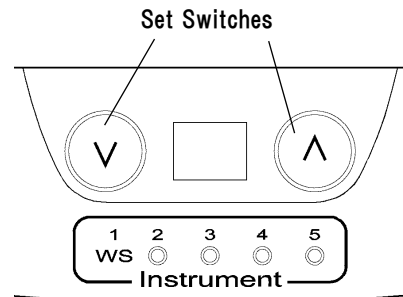

## (4) Instrument Switches and Displays

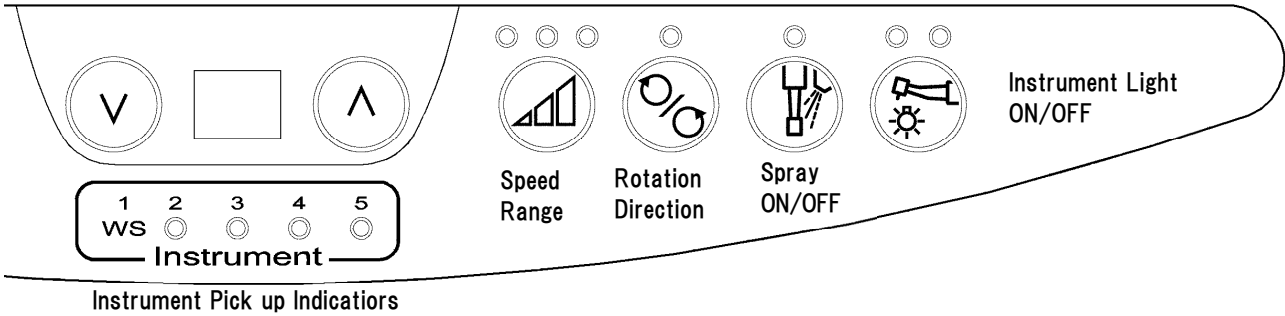

The indicator lights for these switches show if they are on or off or what the setting is. Settings can all be memorized.

<b>⚠ WARNING</b>	
<b>!</b>	<b>Always stop using an instrument before changing any settings.</b> >> Changing settings while an instrument is actually in use could result in a serious accident.

### 1) Instrument Selection

An instrument is recognized as selected and ready for use when it is taken out of its holder. (no included threeway syringe) And it keeps its priority until it is put back again. Instrument circuits which on using; it's picked up indicator for each number of circuits lamp will light up. (See illustration to the right.)

Yet, selections depend on model for order array of holder.

### 2) Display

The display shows various settings and information. The following are its main functions:

- >> When instruments are all put away
  - A: Lock Situation display (When chair lock settled on: see section 5)
- >> When an instrument is selected
  - B: Shows instrument settings (HS/LS)
  - C: Shows ultrasonic scaler\* power (when equip: see section 4)
- >> When Various setting operated
  - D: Shows settings (HP/CH/Setting number)

<Instrument circuits which on using>

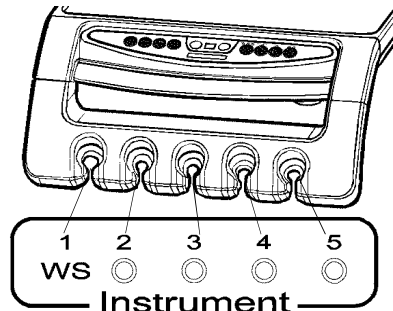

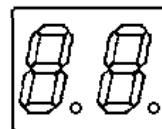

It's picked up indicator for each number of circuits lamp will light up.

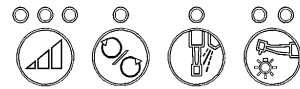

### 3) Switches used for all instruments

These switches work for which ever instrument has been picked up. Each press of the switch changes the setting. The lamp shows what the setting is. Refer to the chart below:

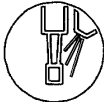
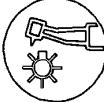

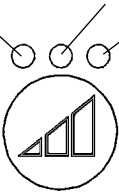
Switch	Lamp	Content
Spray 	Spray On : Green Spray Off : Amber	Turn spray on and off
Light ** 	ON(standard): Green&light off ON(bright): Green&Green OFF : Amber&light off	Turn light on (2 grade of bright) and off
Speed Range *** 	Selected range lamp light up UL / L M H (Amber)(Green)(Green)(Green) 	Air Turbine (no switch of power)  Micromotor Ultra Low/Low/ Medium/High

\*\* Does not work if not equipped with light



\*\*\* Differs somewhat depending on instrument

### 4) Using Set Switches

Pick up the instrument and look at the display.

a) Used the upper and lower switch to change the setting. Refer to the chart below.

b) Settings for each instrument will be stored in memory.

Set Switches	Selections
  (-) (+)	< Air Turbine > (Non changeable item)  < Micromotor > (Non changeable item)  < Ultrasonic Scaler > * Maximum Power Level****

Set Switches

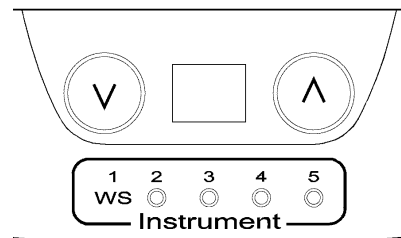

\*\*\*\*Selections depend on model.

\* : Option

## 5) Air Turbine Settings

Press the switch to change the setting. Lamp indicates setting.

< Air Turbine Setting switch >

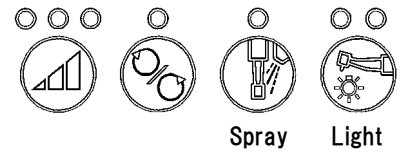

Spray Light

## 6) Micromotor Switch

Press the switch to change the setting. Lamp indicates setting.

Switch	Lamp	Content
Rotation Direction 	Green : Forward Amber : Reverse	Forward or Reverse Rotation

< Micromotor Switch >

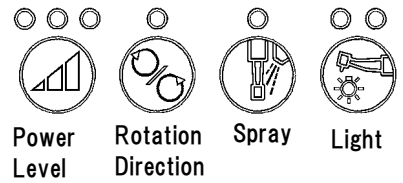

Power Level



Rotation Direction

Spray

Light

## 7) Ultrasonic Scaler\* Switch

Press the switch to change the setting. Lamp indicates setting.

Switch	Lamp	Content
Power Level ** 	Green lamps for: PER. END. SCL. 	Weak : PER. (Periodontal) Medium : END. (Endodontal) Strong : SCL. (Scaling)

< Ultrasonic Scaler Switch >

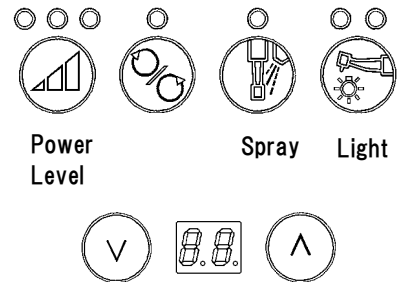

Power Level

Spray

Light

\*\*Settings may differ depending on model.

\* : Option

## (5) Chair Lock and HP Lock

Put away all the operator and assistant instruments; hold the setting switch about 5 second then displays will returned back to manual selections.

Make settings whenever necessary responds. All settings will be continuance.

To quite the display, pick up any instrument. Display will return back when you put the instrument away.

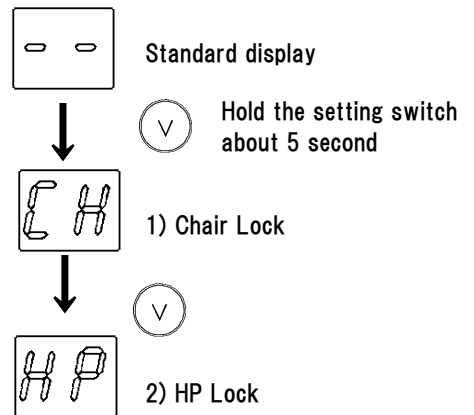

### 1) Chair Lock

This locks the chair in place. Use this if the chair shouldn't be moved or when you leave the room for a while.



- Press the setting switch and change to the chair lock display.
- Press the rotation direction switch and select ON (lock) or OFF (unlock).  
When on lock, switch will light on with amber color and [CH] on the display will blink.

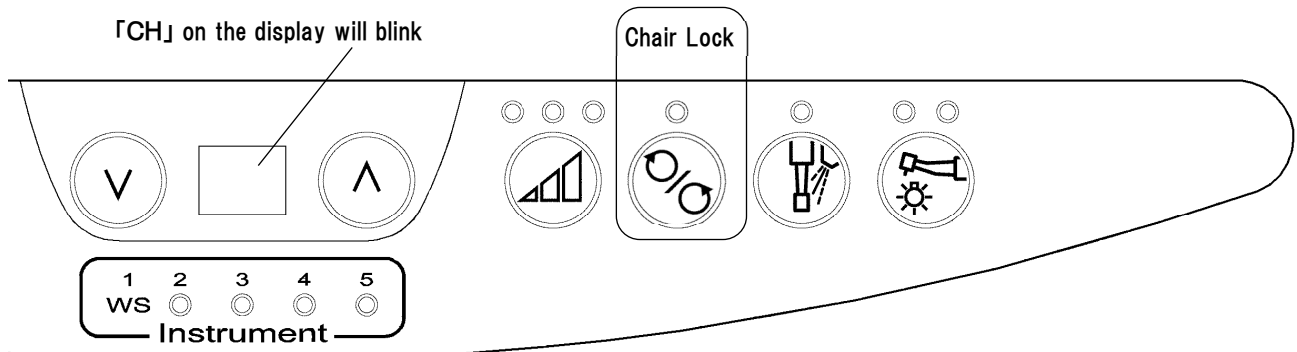
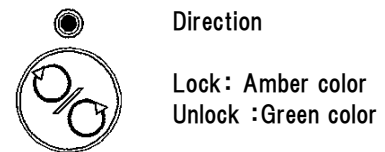

- To quite the display, pick up any instrument.  
Display will return back when you put the instrument away.  
And when put it back again operation will automatic returning back On unlock or re-setting state, follow the a) procedure and back to the beginning.

## 2) HP Lock

This will disable the selected operator instrument. Use this if an instrument has been disconnected.

The locked instrument cannot be used and will not respond if it is picked up.

a) Press the setting switch and change to the HP lock display.

b) The numbers 2 to 5 correspond to the instruments in the holder starting at the left side. Press the instruments used switch for selection ON (lock) or OFF (unlock).

When the instruments on lock, pick up display will light off.

**CHECK**

When unlock, pick up display will light on. Yet, circuit without handpiece equipment will always light off.

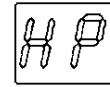

HP Lock

< Instrument circuits which on using >

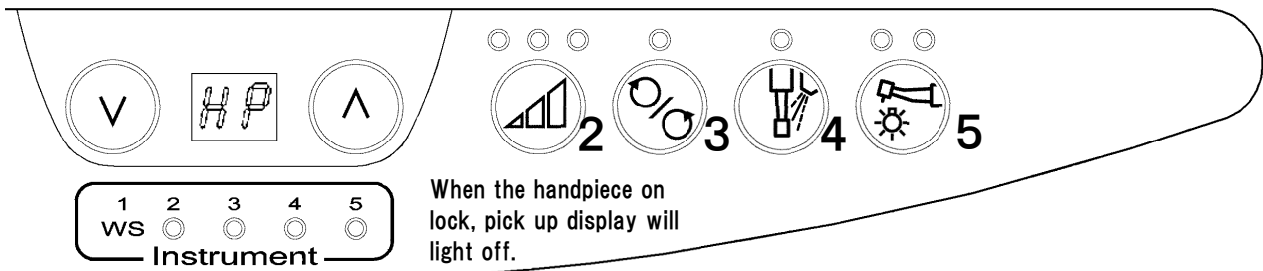
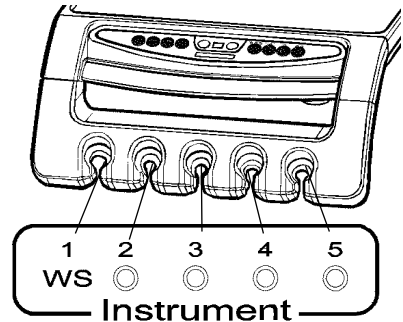

c) To quite the display, pick up any instrument.

Display will return back when you put the instrument away.

And when put it back again operation will automatic returning back. On unlock or re-setting state, follow the a) procedure and back to the beginning.

## (6) Instrument Switches and Displays (SwingType)

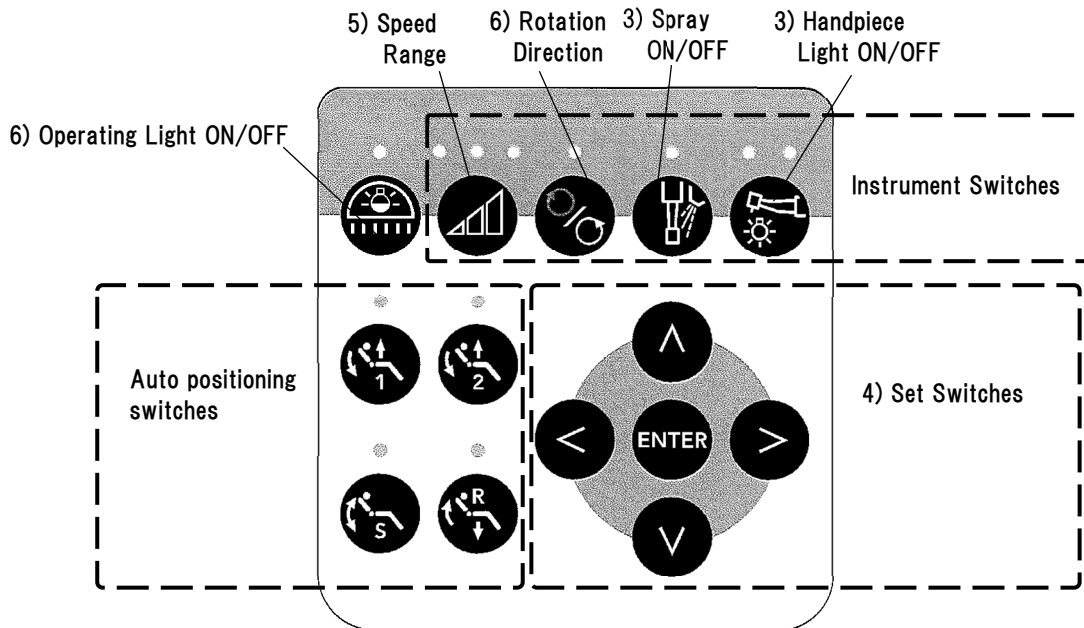

The indicator lights for these switches show if they are on or off or what the setting is. Settings can all be memorized. Up to 5 users can memorize their own individual array of settings.

### 1) Instrument Selection

An instrument is recognized as selected and ready for use when it is taken out of its holder. And it keeps its priority until it is put back again.

### 2) Display

The display shows various settings and information. The following are its main functions.

#### ADVICE

If nothing is used for about 3 minutes, the unit will go into stand-by mode, and the lamps will turn on in order.

Once a switch is pressed or an instrument is used, the indicators will return to their normal appearance.



Display (Swing Type)

When instruments are all put away  
A: Main Display





When an instrument is selected  
B: Shows instrument settings

Whenever Required  
C: Guidance or other messages

\* : Option

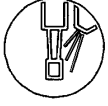
### 3) Switches used for all instruments

These switches work for which ever instrument has been picked up. Each press of the switch changes the setting. The lamp shows what the setting is. Refer to the chart below:

Switch	Lamp	Content
Spray 	Green: Spray On Amber: Spray Off	Turn spray on and off
Light *1 	Amber: Off Green: On Green + Green: On (High)	Turn light on and off
Speed Range *2 	Selected range lamp lights up U L / L M H (amber) (green) (green) (green) 	Air Turbine Low / Medium /High
		Micromotor Ultra Low Low Medium High U L / L / M / H

\*1 Does not work if not equipped with light

\*2 Differs somewhat depending on instrument

### 4) Using Set Switches

Pick up the instrument and look at the display.  
Use the triangle switches to move the cursor and select the desired item. Use the plus and minus keys to make the setting. Refer to the chart below.  
Settings for each instrument will be memorized.

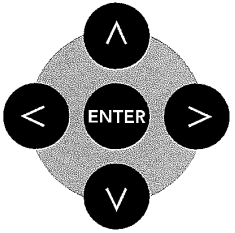
Set Switches	Selections
 <p>Use the Left and Right Switches to move the cursor and select the item. Then press Enter. Use the Up and Down Switches to change the setting. Then press Enter again.</p>	Air Turbine Maximum: Speed Micromotor Maximum: Speed for a speed range Convert speed for attachment gear ratio Tip air on or off Ultra Sonic: Scaler Maximum Power Level *3

\*3: Number of levels depends on scaler model



## 5) Air Turbine and Micromotor Settings

There is no special operation.

## 6) Micromotor Switch

Press the switch to change the setting. Lamp indicates setting.

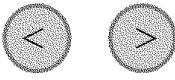
Switch	Lamp	Content
Rotation Direction 	Green: Forward Amber: Reverse	Forward or Reverse Rotation
Speed Display Selection*5 	Changes speed that appears in display	Forward or Reverse Rotation



< LS Speed Display >

Motor rpm :  
Attachment rpm

\*5 Requires user to make setting. See [5] 3, (7) ⑤ H & I in this manual.

## 7) Ultra Sonic Scaler Switch

Press the switch to change the setting. Lamp indicates setting.

Switch	Lamp	Content
Power Level 	Green lamps for PER END SCL 	Weak Medium Strong PER/END/SCL

Press the switch to change the setting. Lamp indicates setting.

## 8) Operating Light Switch

Press the switch to change the setting. Lamp indicates setting.

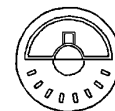

\* : Option

## (7) Menu Selection and User Settings (Swing Type)

Put away all the doctor and assistant instruments so that the Main Display appears. Then press the Up and Down cursor keys to view the various menus.

Press Enter to select a menu and then press the Left or Right cursor key to change the setting. Finally press Enter again. All settings will be memorized.

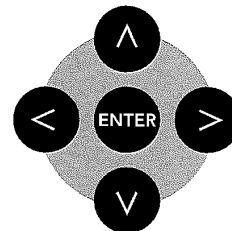

Press Up and Down keys to change menus  
Press Enter to select a menu.  
Change setting with Right or Left key Press Enter again.

### ADVICE

To return to the Main Menu, pick up any instrument. The Main Menu will appear when you put the instrument away.

### Change Main Display.

You can use any of the 5 menus described below as the Main Display. Select the one you use most frequently.

Simply select the desired menu and hold down the Enter key for 5 seconds to make it the Main Display.



Hold down Enter for 5 seconds to change Main Display

### 1) Handpiece Lock

This will disable the selected doctor instrument. Use this if an instrument has been disconnected.

The locked instrument cannot be used and will not respond if it is picked up.

- a) Display the Handpiece Lock Menu and press Enter.
- b) Use the Right or Left cursor key to select the number of the instrument. Press the Enter key to lock it or unlock it.
- c) The numbers from 2 to 6 on the holder correspond to various handpieces.  
The lamp for a locked instrument will be green and blink on and off. Repeat step b) above to lock or unlock other handpieces.
- d) Hold down the Enter key for 2 seconds when you are finished to go back to the Main Display.

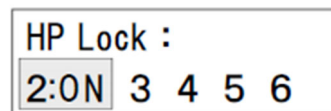

Press Enter to select and change



Hold down for 2 seconds to complete the procedure.

### 2) Operator Selection

Five arrays of settings for both handpiece and user settings can be memorized. These arrays are identified by Operator numbers 1 to 5. Changing the Operator number will change the array of settings in use.

This is convenient if a single unit is being used by multiple doctors.

- a) Display the Operator Menu and then press Enter.
- b) User the Right or Left cursor key to select the number for the operator and then press Enter again.
- c) The normal settings for that operator will be activated.

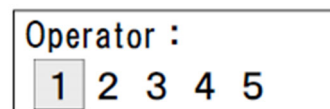

Press Enter to select this menu and again to set the operator number.

### 3) Chair Lock

This locks the chair in place.  
Use this if the chair shouldn't be moved or when you leave the room for a while.

- Display the Chair Lock and then press Enter.
- User the Right or Left cursor key to select "On" (locked) and then press Enter again.
- To release the Chair Lock, repeat step a) above, select Off (unlocked) and finally press Enter.

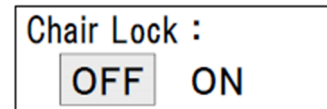

Press Enter to select this menu and again to lock or unlock.

### 4) Restore Original Settings

This will cancel any changes made and restore the original memorized settings (see part 5), section B below).  
This makes it easy to cancel multiple new settings all at once.

#### ADVICE

Memorized settings can be made for each individual operator number. Original memorized settings are restored only for the operator number in current use. To change settings for other operator numbers, select each of those numbers in turn. (See part 2) above.)

- Display the Initial Reset Menu and press Enter.
- Select "On" with the Right cursor key and then hold down the Enter key for 5 seconds.

#### ADVICE

It is not possible to undo the reset procedure and go back to the settings that have been canceled.

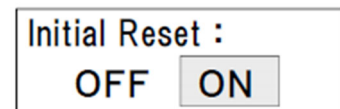

Press Enter to select display



Hold down Enter for 5 seconds to reset.

### 5) User Settings

There are various other settings that can be made. Display the User Settings Menu and press Enter.

Then use the Up and Down keys to select one of the possible settings listed below, from A to O, and press Enter again.

Use the Right and Left keys to make the settings and press Enter again.

(If your unit is not equipment with one of the functions, the display for that function will be disabled.)

To complete or abort the procedure, display Return to Main Menu and press Enter. (See part A below.)

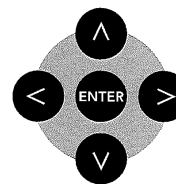
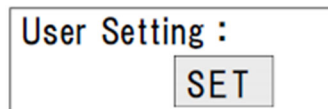

Select setting display with Up and Down keys and then press Enter. Make settings with Left and Right key and then press Enter

#### A) Return to Main Display

To complete or abort a user setting procedure, display Return to Main Display and press Enter. The Main Display will then appear.

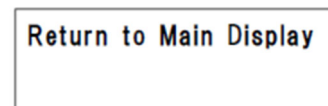

#### B) Memory

Use this to save settings.

- Go to the Initial Memory display and press Enter.

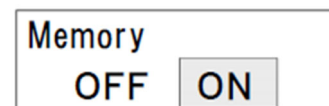

⇨ : Option

b) Press the Right cursor key to select "On" and then hold down the Enter key for 5 seconds. This will save all the current settings. If you change any settings after this, you can return to the Memorized settings by using the Initial Reset display (see step4)above).



Hold Enter down for 5 seconds.

**ADVICE**

It is not possible to undo the reset procedure and go back to the settings that have been canceled. Memorized settings can be made for each individual operator number. Even if the settings are exactly the same, they must be made separately for each operator number.

**C) Scaler Control Mode**

When this is turned "On," the scaler is turned on by stepping on the pedal and runs continuously, and it is turned off by stepping on the pedal again. (you don't have to hold the foot pedal down all the time.)

When it is turned "Off," the scaler only runs while the pedal is depressed.



**D) Speed Up Micromotor Attachment Gear Ratio 1**

Make this setting whenever you use an attachment that has a gear ratio which speeds up the rotation.

This can be set from 1.0 to 5.9 in increments of 0.1.

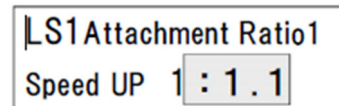

**CHECK**

This ratio along with the speed of the motor is used to calculate the rotation speed. However, it is only an estimate and may differ somewhat from the actual speed depending on the specifications of the attachment and other factors.

**E) Slow Down Micromotor Attachment Gear Ratio 2**

Make this setting whenever you use an attachment that has a gear ratio which slows down the rotation.

This can be set from 1.0 to 1024 in increments of 0.1.

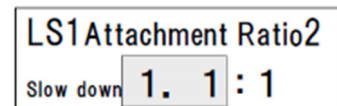

**CHECK**

This ratio along with the speed of the motor is used to calculate the rotation speed. However, it is only an estimate and may differ somewhat from the actual speed depending on the specifications of the attachment and other factors.

**F) Operating Light-Handpiece Link**

When this is enabled, the operating light turns on when an instrument is picked up and goes off when the instrument is put away.

\*Only for units equipped with auto light function.

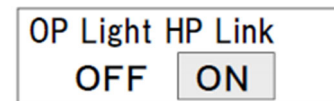

**G) Operating Light-Chair Link**

When this is enabled, the operating light turns on and off depending on the chair auto position.

\*Only for units equipped with auto light function.

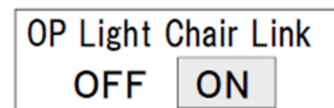

\* : Option

## H) Chair Auto Positioning Patterns

There are 3 auto positioning patterns: Simultaneous Seat and Backrest Start Simultaneously.

This takes the least time but is more stressful for the patient.



### Delayed Backrest Starts 1 Second After Seat

This takes a little longer but is less stressful.

(Recommended.)

### Separate Backrest Starts After Seat Stops

This takes the longest but is the least stressful.

## I) Power Save

This can be used to save power and for safety.

Select either 60 or 120 minutes or turn this function off.

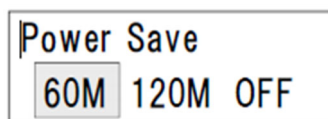

## J) Spray Timing for constant speed handpieces

There are two possible settings for this.

LS (micromotor) and HS (air turbine) settings are made separately. Immediate: As soon as the pedal is pressed.

Delayed: After pedal is pressed down far enough

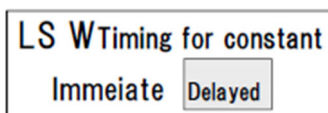

< micromotor >

### ADVICE

This setting cannot be made separately for two air turbines or for two micromotors.

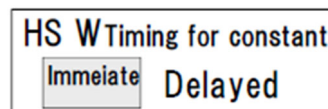

< air turbine >

## K) Spray Timing for variable speed handpieces

There are two possible settings for this.

LS (micromotor) and HS (air turbine) settings are made separately. Immediate: As soon as the pedal is pressed.

Delayed: After pedal is pressed down far enough

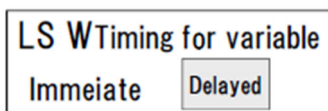

< micromotor >

### ADVICE

This setting cannot be made separately for two air turbines or for two micromotors.

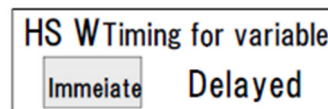

< air turbine >

## 4. Assistant's Switch Panel

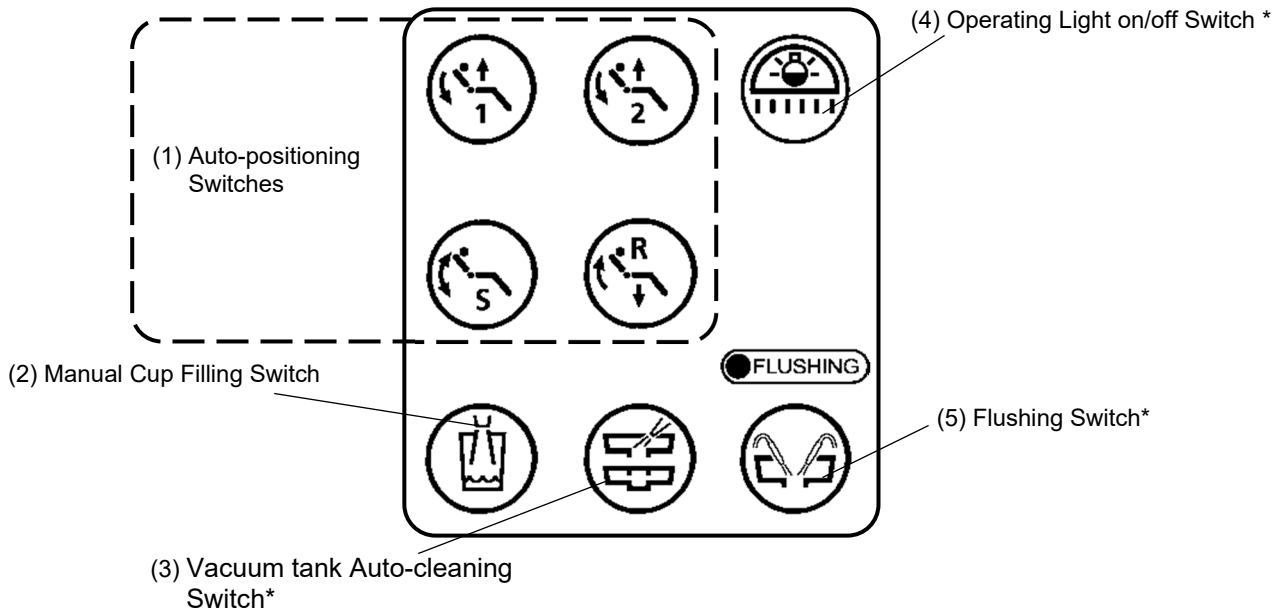

Illustration above shows the switches on the assistant's switch panel. A switch is disabled if the unit is not equipped with the corresponding function.

### (1) Auto-positioning Switches

These are used in the same way as those on the dentist's side. Refer to section [5] 3. (1) of this manual.

- 1) **Position 1 and position 2.**
- 2) **R**
- 3) **S**

#### ADVICE

Position setting cannot be changed with the assistant's side switch panel. It can be changed with the dentist's side switch panel.

### (2) Manual Cup Filling Switch

Press this to fill cups manually.  
Water flows only while this switch is being held down.

#### ADVICE

Make sure a cup is in place. Otherwise, water might spill and be splashed around the area.

### (3) Vacuum Tank Auto Cleaning Switch

This only works if the unit has this function. \*\*  
Press this switch to automatically clean the vacuum tank. For details refer to [5] 7. in this manual.

### (4) Operating Light On/Off Switch

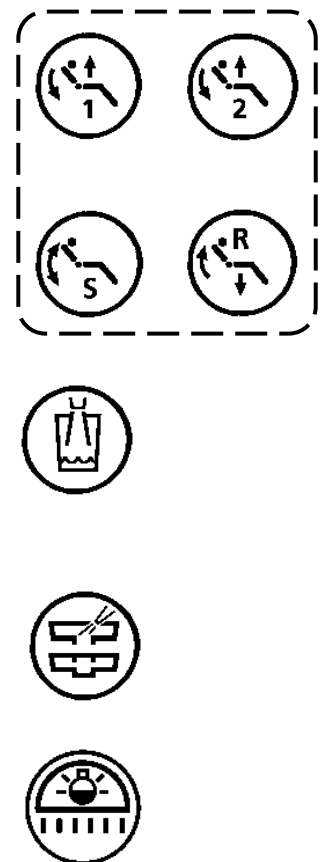

Press this switch to turn the light on and off. Only for units that have the auto light function. \*\*

\*\*Not functional if unit is not equipped with specified function.



\* : Option

## 5. Instrument Holder

 CAUTION	
	<p><b>Before moving the seat or backrest, make sure the instrument holder is clear and will not be hit by them.</b>                      &gt;&gt; Otherwise, the equipment could be seriously damaged.                      To adjust the holder's position, grip the holder or its arm firmly and turn it slowly and carefully.</p>
	<p><b>When adjusting the position or angle of an instrument holder, grip the holder or its arm firmly and move it carefully.</b>                      &gt;&gt; Do not grip the instrument section or use excessive force; this could seriously damage the holder.</p>
	<p><b>Never put a load greater than 10 N (1 kgf) on the assistant's auxiliary tray.</b>                      &gt;&gt; This could seriously damage it.</p>
	<p><b>Do not load the main tube (when the tray is drawn with the main tube, or strongly pulls when wiping &amp; etc.).</b>                      &gt;&gt; This could result in air or water leakage as well as serious damage.</p>

### (1) Dentist's 5 Instrument Holder

 CAUTION	
	<p><b>Never use force to disconnect or take apart the main tubes, or holder.</b>                      &gt;&gt; If the holder is not taken apart in the proper way, it could be seriously damaged.</p>

#### 1) Top Cover Removal

The holder's top cover can be removed for easy cleaning and disinfecting.

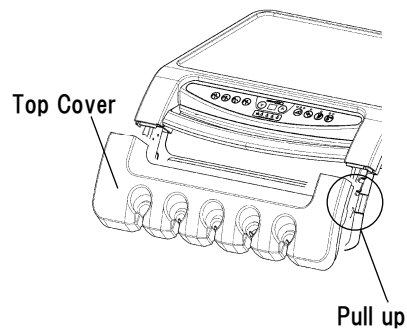
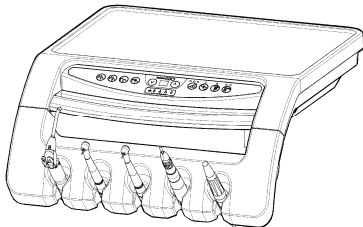

### (2) Dentist's 5 Instrument Holder (swingtype)

This holder is integrated with the dentist's swing table. The connected instruments are located in the holders on the top of the dentist's swing table. Normally, the instruments must be returned to these positions.

#### 1) Holder cover removal

The holder cover at the front of the holder can be removed for easy cleaning, and it supports disinfection (135°C) in an autoclave. Tear it away from the left or right edge of the holder.

When re-attaching the holder cover, align it correctly, and fit it into position.

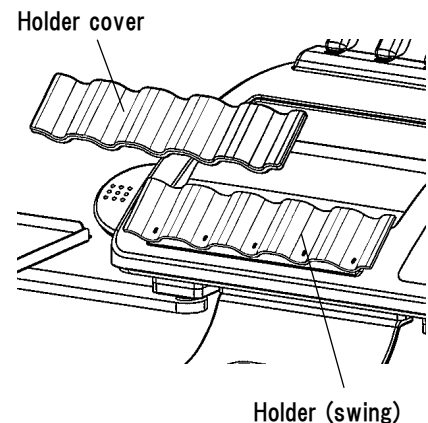

## (3) Assistant's Holder

<b>⚠ WARNING</b>	
<b>⊘</b>	<p><b>Do not place any object on, exert excessive force or strongly pull the assistant's arm. Moreover, keep hands, feet clear and never sit on the arm.</b></p> <p>&gt;&gt; These actions could cause the equipment resulting in injury or damage.</p>
<b>!</b>	<p><b>Avoid accidents that could result injury or damage by paying attention to the points listed below while operating assistant's holder or arm:</b></p> <p><b>1) Keep hands, finger or body clear of all moving parts.</b> (Hold the arm, attach hand on the holder installation base, etc.)</p> <p><b>2) Do not let patients touch it (children play, lean or etc.)</b></p> <p><b>3) Do not put anything that might reach the arm operated area.</b></p> <p><b>4) Avoid any other actions which seem dangerous.</b></p> <p><b>Avoid any other conditions which seem dangerous.</b></p> <p>&gt;&gt; Not paying sufficient attention to the above points could result in injury or damage.</p>

### 1) Assistant's Holder Support

The holder turns horizontally. Since the main part of the arm slides back and forth, position of the arm can be adapted to a treatment style.

When changing the position of the holder, move it slowly, holding a shaft on the bottom of the holder.

When changing the position of the arm, move it slowly, holding the part of the arm under the holder.

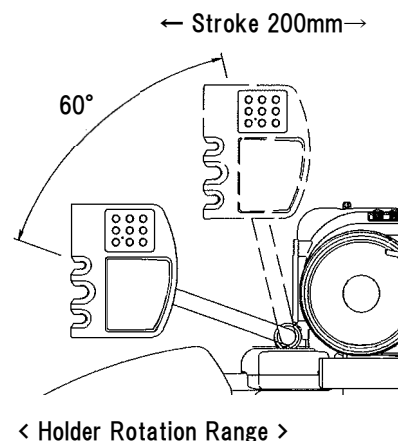

### 2) Assistant's Auxiliary Tray





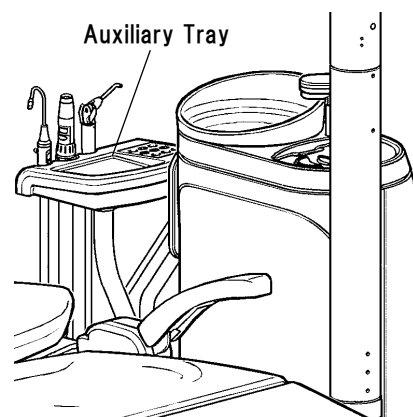

<b>⚠ WARNING</b>	
<b>⊘</b>	<p><b>Never put a load greater than 10 N (1 kgf) on the assistant's auxiliary tray.</b></p> <p>&gt;&gt; This could seriously damage it if the support suddenly went down.</p>
<b>⊘</b>	<p><b>Do not put a medical vial, an alcohol lamp, or other things (mainly, liquids) on the assistant's auxiliary tray that could cause an injury if they fall.</b></p> <p>&gt;&gt; If those fell accidentally while the arm is moving, that would result in an accident. That would cause discoloration of outer surface with chemical solution or machine trouble with running liquid into the inside.</p>

There is a space on a part of the assistant's holder which can be used as an auxiliary table.





## 6 Instruments

 <b>WARNING</b>	
	<p><b>Refer to the individual operator's manuals for the air turbine handpieces, micromotor, ultrasonic scaler and other similar instruments for details and instructions on how to connect and operate these instruments.</b></p> <p>&gt;&gt; Improper operation and handling of these instruments could result in an accident resulting in injury or damage to the instrument.</p>
	<p><b>Return instruments to their holders carefully and make sure they are properly secured.</b></p> <p>&gt;&gt; If an instrument is not properly secured in its holder, there could be some confusion about which instrument is presently selected for use. This could result in an accidental injury or damage to the equipment.</p>
	<p><b>If the main tube for the air turbine swells up during use, stop using it immediately and check the air exhaust line.</b></p> <p>&gt;&gt; If the main tube's air exhaust line is pinched or plugged up, the tube could swell up and burst resulting in an accident or equipment damage.</p>
	<p><b>Never pinch or excessively bend the main tubes, especially the air turbine tube when it is running.</b></p> <p>&gt;&gt; Using an instrument when the main tube is pinched could block the air and exhaust line and cause the tube to swell up and burst resulting in an accident or equipment damage.</p>
 <b>CAUTION</b>	
	<p><b>Please pay close attention, and do an appropriate action promptly when some abnormalities occur when appropriate the air jetted from each instrument to patient's gums.</b></p> <p>&gt;&gt; When air is used for gums, the syndrome of happening by accident such as the subcutaneous emphysemas might be caused.</p>

See section [5]3.(3)[Instrument switches and displays] for the instrument operation.

### (1) Air Turbine Handpiece

#### 1) Operation

Take the handpiece out of its holder and step on the foot pedal to operate it. It rotates at a high speed.  
Selected spray ON, rotation & spray can be operating by foot pedal.

#### 2) Air turbine variable speed settings\*

If the turbine is the optional variable speed type, the range will determine its speed. Also, the variable speed setting mode is changeable (variable or constant speed).  
Selected spray ON, rotation & spray can be operating by foot pedal.

#### 3) Clean System\*

This prevents the vacuum effect when the handpiece stops running and thereby prevents contamination being sucked into the system. When the turbine stops, the IN side is closed and a little air flows out of the OUT side for about 10 seconds.

## (2) Air Scaler \*

An air scaler can be connected to the air turbine system. It will operate in the same way as an air turbine.

### ADVICE

Recommend installation of air turbine\*\* variable speed setting while using air turbine scaler.  
Oscillation power adjustment is available for variable speed.

## (3) Micromotor

### 1) Operation

Take the micromotor out of its holder and step on the foot pedal to operate it. Step on the foot pedal, spray action will active while selected the spray ON.

### 2) Rotation speed of variable range

If the turbine is the optional variable speed type, the range settings will determine its speed. Go to operator's switch panel to active while selected the speed switch.

The chart to the right shows the speeds for each range.



While rotation running, cooling and the blow air are gushed at the same time. (except UL setting and L setting)

Micromotor Speed Estimates	
Setting	Range (min <sup>-1</sup> ) *1
UL (Ultra Low)	100 - 250 *2
L (Low)	100 - 3,000 *2
M (Medium)	100 - 9,000
H (High)	100 - 40,000

\*1: Factory setting

\*2: Tip Air Off(Factory setting)

### 3) Micromotor Overload Protection Circuit



 CAUTION	
	<p><b>Never press down with steady and excessive force or intentionally cause the motor to stop by overloading it.</b></p> <p>&gt;&gt; Repeated or frequent triggering of the micromotor's overload protection circuit will cause it to overheat and result in damaging the motor.</p>

A sudden and excessive increase in the load on the micromotor will trigger the overload protection circuit, and the motor will temporarily stop running.

This is to prevent overload protection of the motor and the circuit board. Temporarily let go the foot pedal, wait until the overload is relieved, and then press the pedal again to restart the motor.

\* : Option

## (4) Threeway Syringe

<b>⚠ WARNING</b>	
	<p><b>Always check the temperature settings for water warmers, if the unit is equipped with them.</b></p> <p>&gt;&gt; If the heaters are set too high, the patient could be burned or the equipment could be damaged.</p>
<b>⚠ CAUTION</b>	
	<p><b>During hot weather, turn off the heater.</b></p> <p>&gt;&gt; Otherwise, over heating could shorten the working life of the main tube and the heater.</p>
	<p><b>Keep it away from the heating system so that the hot air does not hit it directly.</b></p> <p>&gt;&gt; The heat causes the tube to soften and expand, causing breakage and other damage.</p>

### 1) Operation

This syringe can emit air or water or spray. Press the right lever for air.  
 Press the left lever for water.  
 Press both levers at the same time for a misty spray.

If necessary, water can be warmed. (See 2) and 3) below.)

Press both levers at the same time for a misty spray

### 2) Warm water

The water can be warmed if necessary.  
 The warmer switch is on the basin unit's switch panel.  
 This will warm the water for both the cup and the threeway syringe.  
 (See [5] 7. (2) in this manual.)

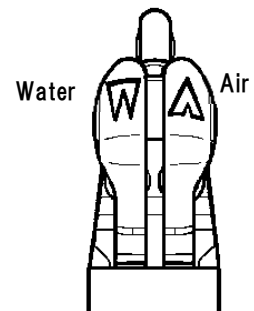

[WS201]

## 3) Heat insulation

<b>⚠ CAUTION</b>	
<b>!</b>	<p><b>During the hot weather or unnecessary thermal, take off the connector tube and turn off the heater.</b></p> <p>&gt;&gt;Otherwise, over heating could shorten the working life of the main tube and the heater.</p>

If the three-way syringe tube is equipped with a heater \*, the air it emits can be warmed.

Turn OFF the unit main switch before performing the following procedure. (same for both Dentist's and assistant's syringe)

- a) The heater plug is right next to the main tube which is connected to the chair. Plug it into its mate on the chair. Make sure the plug is turned the right way.
- b) Turn the main switch ON; the heater inside the tube will warm the air for the syringe.

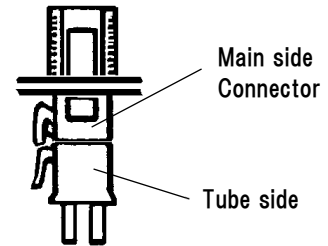

### <Temperature Adjustment>

Use a miniature screwdriver to turn the temperature adjustment shaft (see diagram to the right).

The operator's and assistant's syringes are adjusted separately.

### CHECK

How warm the air gets depends on the room temperature and how frequently it is used. Make sure the heater is properly adjusted and does not overheat.



The temperature adjustment for the operator's syringe is on the back of the tray.

The temperature adjustment for the assistant's syringe is inside the basin unit.

### <Operator's side>

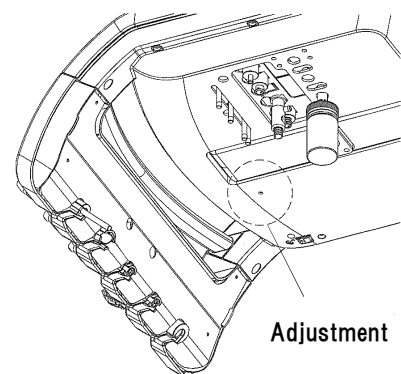

\* : Option

## (5) Threeway Syringe WS201 <Removable Nozzle>

<b>⚠ CAUTION</b>	
<b>!</b>	<p><b>Make sure the tube screw which located at syringe rear end been tightened before using threeway syringe WS-201.</b></p> <p><b>If the screw was loosen, used fingers to turn in and tightened.</b></p> <p>&gt;&gt;Otherwise, this could cause the top of tube or internal syringe will dashes out, an unexpected accident caused, and water or airleakage.</p>

For operation and settings, see (4) above.

### 1) Remove Nozzle

The nozzle can be removed and autoclaved.  
Hold down the push button, grip the cover nut and pull the nozzle straight out.

### 2) Nozzle Attachment

To reattach the nozzle, hold down the push button, grip the cover nut and push the nozzle straight in.

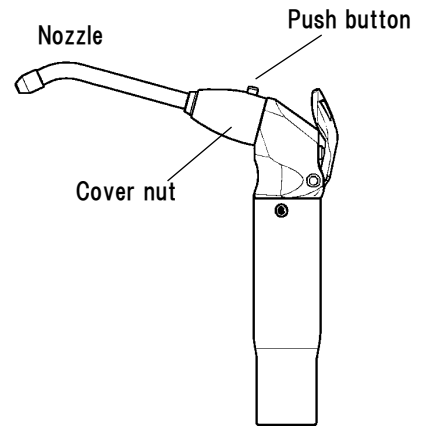

## (6) Threeway Syringe WS97/WS-90P\* <Removable Nozzle and Body>

For operation and settings, see (4) above.

### 1) Remove Body

The body can be removed and autoclaved.  
Hold down the push button for the body and pull it straight off.  
To reattach it, push it straight in until it clicks into place.

### 2) Body Attachment

To reattach the body, hold down the push button and push it straight on.

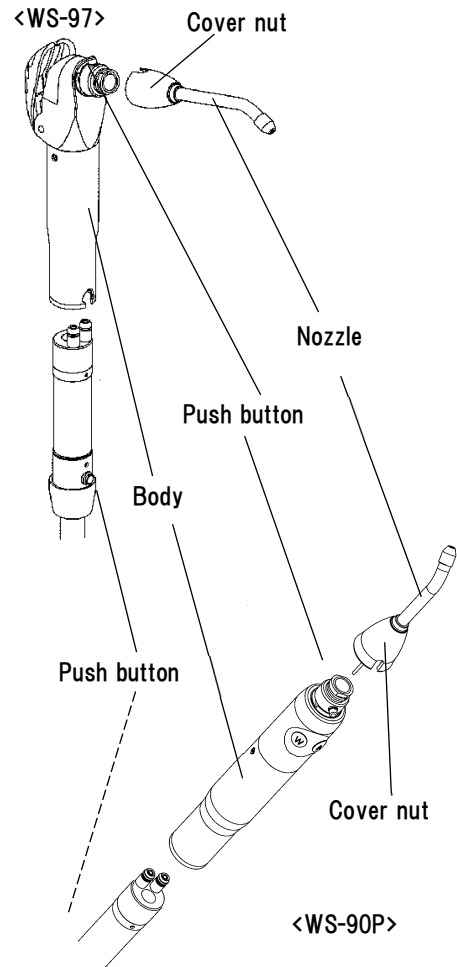

## (7) Vacuum Syringe VS-110

### 1) Operation

- a) Suction Power ON/OFF  
This syringe begins to operate when it is taken off its holder on the assistant's side and stops when it is returned to its holder.
- b) Adjustment of suction power  
Suction power can be adjusted by sliding the plate on the center of the syringe body. Refer to the right illustration.

### 2) Connection of the tip

Insert the tip into the recess of the syringe body firmly.

### 3) Disassembly of the syringe body

Syringe body is autoclavable, and it can be disassembled as the right illustration. Hold the back and forth of the syringe firmly and then unscrew the body.

### 4) Adjustment of body angle of the rotary type syringe\*

Body angle of the rotary type syringe to the tube can be adjusted by rotating the root of the syringe. Adjust it if the need arises. Turn the root of the syringe, holding the back and forth of the rotating part firmly.

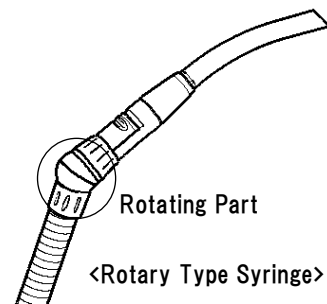
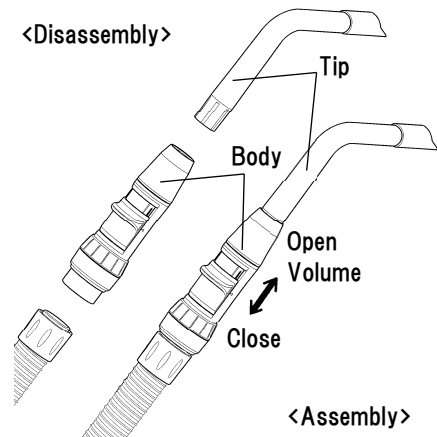

## (8) Saliva Ejector SE-110

### 1) Operation

- a) Suction Power ON/OFF  
The saliva ejector begins to operate when it is taken off its holder on the assistant's side and stops when it is returned to its holder.
- b) Adjustment of suction power  
Suction power can be adjusted by turning the lever on the center of the syringe body. See the right illustration.

### 2) Connection of the SE nozzle

Insert the SE nozzle to the top of the rubber part of the ejector until it cannot unfasten easily. The SE nozzle is flexible and its angle can be changed freely.

### 3) Disassembly of the body

Syringe body is autoclavable, and it can be disassembled like the right illustration.

Hold the back and forth of the syringe firmly and then unscrew the body.

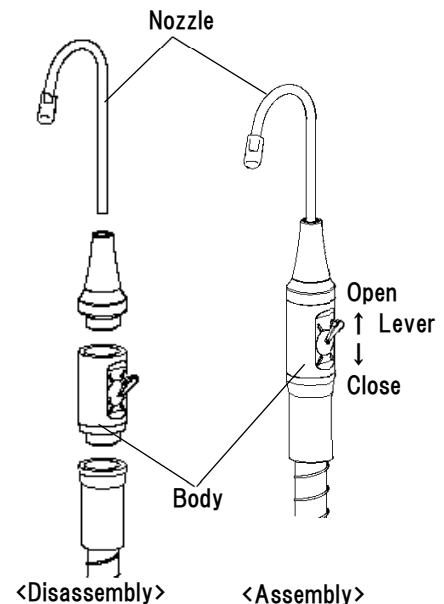

\* : Option

## (9) Ultrasonic Scaler\*

### 1) Attaching the handpiece

#### LED without light

Align the notch on the handpiece side with the mark on the tube side and insert the syringe.

#### With LED Light

Align the handpiece side mark with the tube side mark and insert the syringe.

Please connect the handpiece and tube reliably.  
It may unexpectedly deviate if it is not securely connected.

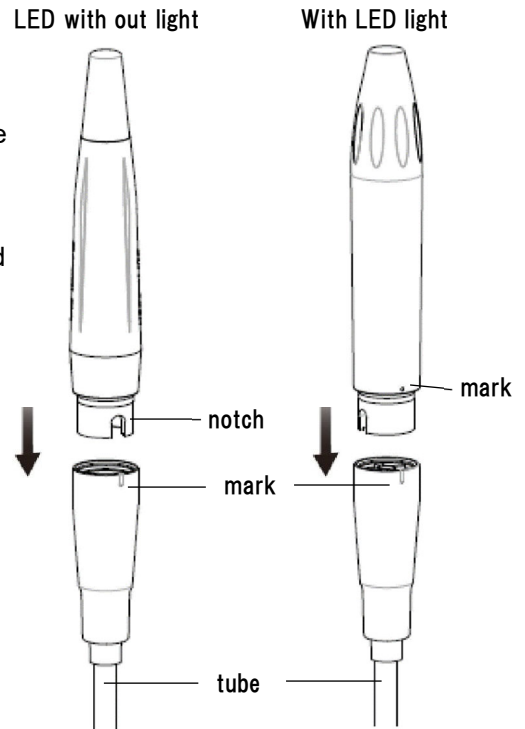

### 2) Operation

Step on the foot pedal to operate the scaler. It vibrates at a steady rate. When the spray is turned on, it will be emitted when the foot pedal is depressed.

There are 20 power levels(0.5~10) for each power range.  
The upper limit for each range can be set. (See section [5]3.(3)4) ) The vibration level is shown in the display. (Refer to level estimate.)

Power Level Estimates	
Setting	Power Range
PER (Weak)	0.5(weakest) - 10
END (Medium)	0.5 - 10
SCL (strong)	0.5 - 10(strongest)

\* : Option

## (10) Adjust for Air and Water Flow

Air and water flow can be adjusted in the following ways:

### 1) Operator's Instruments

Adjustment knobs are located on the back of the operator's tray with labels that show how to use them.

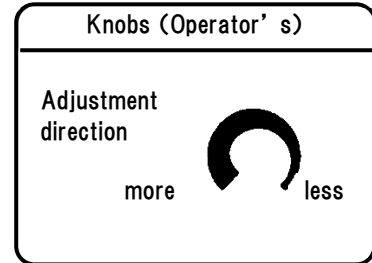
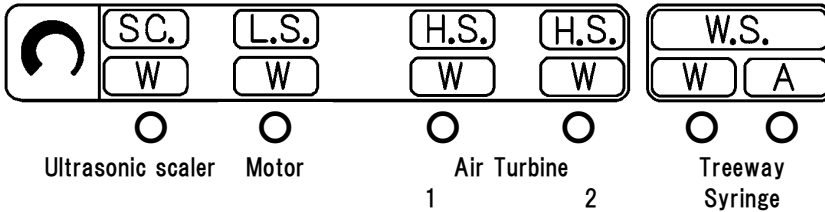

>>Knobs arrangement will follow by the equipment specification.



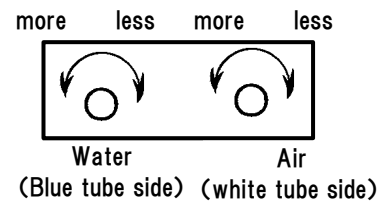

### 2) Assistant's Threeway Syringe\*

- Open the unit door.
- Turn the valves knob on the upper right inside the unit, follow the marks and process the adjustment.
- Close the unit door.





## 7. Basin Unit

 <b>WARNING</b>	
	<p><b>Never lean on or sit on the basin unit. Do not set heavy objects on it or allow any excessive force to be applied to it.</b></p> <p>&gt;&gt;Any of the above actions could cause the unit to suddenly turn resulting in an accident, bodily injury or damage to equipment.</p>
	<p><b>Do not move the seat or backrest if the door on the basin unit is open.</b></p> <p>&gt;&gt;Doing so could cause an injury or damage.</p>
 <b>CAUTION</b>	
	<p><b>Ensure the area is clear of obstacles before opening the door.</b></p> <p>&gt;&gt;Otherwise the door or other equipment could be damaged.</p>

### (1) Basin Unit

#### 1) Open and Close Basin Unit Door

Do this to clean the vacuum tank and perform other maintenance inside the basin unit.

- a) Open the door by pressing on the catch in the center along the right hand side. The door opens at an angle of approximately 100 degrees.
- b) Close the door by pushing it in until the catch holds it closed.

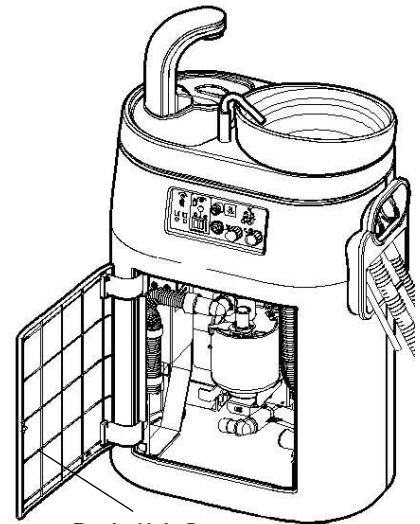

Basin Unit Door

## 2) Basin Unit Panel

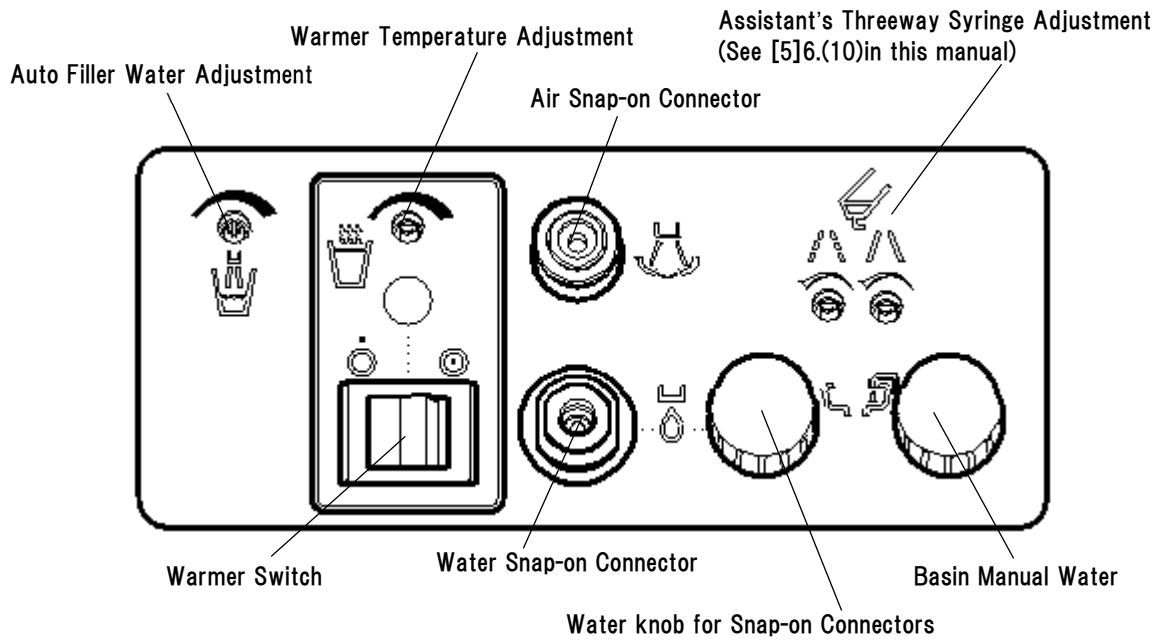

These are the adjustments and connections on the basin unit panel. Their uses are explained below, and in sections [5] 7. and 8. of this manual.

## 3) Vacuum Tank Auto-cleaning System\*

This system cleans the vacuum tank with both air and running water.



Vacuum Tank Auto-cleaning Switch

## (2) Warmer

<b>⚠ CAUTION</b>	
	<p><b>Whenever the warmer is turned on pay close attention to how hot the water is. Turn the warmer off whenever it is not needed such as in the summer.</b></p> <p>&gt;&gt; Otherwise, the water could get too hot and burn the patient. Also it could overheat and breakdown.</p>

When the warmer is on, all the instruments and the auto cup filler receive a supply of warm water.

### 1) Warmer Switch

The switch that turns the warmer on and off is located on the basin unit panel.

When the switch is turned on, a light above it lights up and the warmer starts to work. The instruments will receive warm water once the heater has had enough time to warm it up.

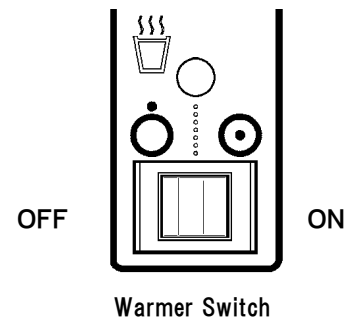

### 2. Warmer Temperature Adjustment

The warmer temperature is set at the factory before shipping, but it can be adjusted in the following way:

- a) Turn the temperature adjustment to change the temperature of the water. Use a miniature flat head screwdriver.
- b) After waiting for a while, check the temperature of the cup water and the threeway syringe. Do this several times if necessary.

#### **CHECK**

When the warmer is on, the water will not be uniformly warm throughout the various systems. Watch out for places that are hot and be aware of the temperatures of various parts of the system.

- c) Check that the water temperature is proper for use.

### Warmer Temperature Adjustment

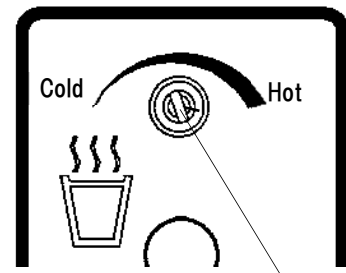

With a miniature flat head screw driver

## (3) Water and Air Snap On Connectors

### ⚠ CAUTION



**Ensure these connections are correctly made before using.**

>> If the connection is not correctly fixed in place, water or air could leak or the joint could come off.

If necessary, a supply of water or air can be drawn from this connection on the basin unit panel. Use the special snap-on joints\* to draw water or air from their connections.

### 1) Use

- a) Connect the joint to the snap on connection. Push it all the way in until it clicks into place.
- b) Water flow can be adjusted with the valve above the connector. Air will flow at a steady rate depending on the pressure inside the chair unit.
- c) Take the water joint off by pressing the release button and pulling it out. Disconnect the air connector by push the ring forward and pulling it off.

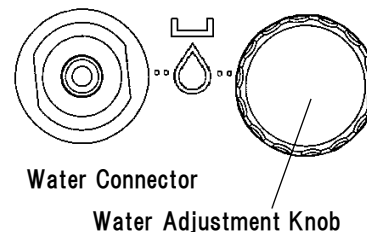

### ADVICE

Grip the connectors firmly to disconnect them. Internal pressure could give them some spring when they are disconnected. Please put some Vaseline on the top of joint, smoothly carry out the maintenance per month and be careful do not scraps the O ring.

## (4) Basin

<b>⚠ CAUTION</b>	
<b>⊘</b>	<p><b>Do not drop or bump the basin when it is taken off the unit. Do not scrub it vigorously or use hard or sharp objects on it.</b>                      &gt;&gt; Any of the above could damage or spoil the basin.</p> <p><b>Do not leave chemicals with dark or strong colors in the basin for too long. If some chemical solution happens to be spilled in it, wash it out thoroughly with running water and then wipe it with a sponge or other suitable implement.</b>                      &gt;&gt; Otherwise, the spittoon could become permanently discolored.</p>
<b>!</b>	<p><b>Ensure the basin and its nozzle are securely attached. Do not use a basin if it is cracked, chipped or otherwise damaged. Replace it immediately.</b>                      &gt;&gt; If the basin has not been correctly installed, water could leak, or it could fall off the basin unit. Using a damaged basin could result in an injury.</p>

### 1) Basin Auto Rinsing

The basin is automatically rinsed out for a specified time whenever The auto cup filler is used.

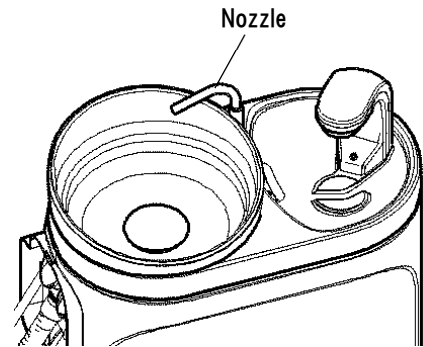

### 2) Manual Basin Rinsing

The basin can be rinsed anytime it gets dirty, or it can have a constant flow of rinse water running through it. Open the valve inside the basin unit to rinse out the basin. The valve also adjusts the flow of water.

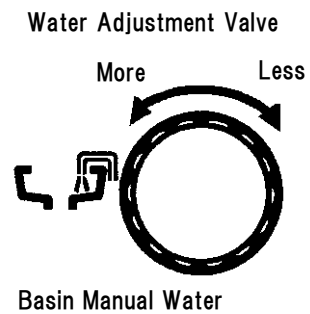

## 8. Water Fountain

<b>⚠ CAUTION</b>	
<b>⊘</b>	<b>Do not bump the fountain or expose it to other types of physical shocks or excessive stress.</b> >> This could damage the fountain and cause it to stop working.
	<b>Never run water through the fountain if its nozzle has been removed.</b> >> This would result in water shooting straight up in the air.

### (1) Auto Filler

<b>⚠ CAUTION</b>	
<b>!</b>	<b>If the sensor is dirty, wipe it carefully with a dry cloth.</b> >> Otherwise, the auto filler will not work right.

#### 1) Auto Cup Filling

Place a cup on the stand. (The cup can be of any material, paper, metal, etc.) The cup will be detected and filled to the specified level. If the cup is already full when it is detected, a little water will run and then stop.

#### CHECK

Do not use transparent or semi-transparent cups. They may not be detected by the sensor.

#### ADVICE

To prevent accidental activation, there is a 1 second delay after the cup is set in place before the water starts to run. Put the cup in place carefully.

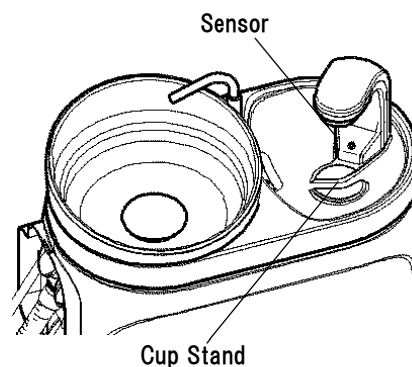

#### 2) Set Cup Water Level

This is set at the factory using the small dental cup as a standard. It can be changed in the following way:

- a) The adjustment screw is on the basin unit panel. Use a small flat head screwdriver.
- b) Follow the marking for the screw to adjust the level.
- c) Put a cup in place and check the level.

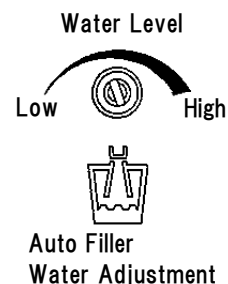

### 3) Manual Cup Filling

Hold down the manual cup filler switch on the assistant's side. Water will fill the cup only while the switch is held down.

#### ADVICE

Ensure a cup is in place before doing this; otherwise, water will be splashed around.



Manual cup filler switch  
<Assistant's Side>

### 4) Cup Stand Drain

There is a drain around the cup stand. Spilled water is discharged into the drain.

#### CHECK

If something like a prosthetic device falls into this drain, refer to section [6] 8. in this manual for instructions on how to open the drain trap.

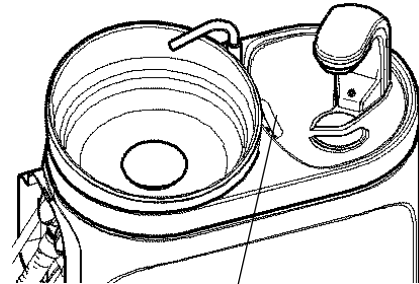

#### ADVICE

Do not drain debris or contaminated water intentionally. It will cause clog.



Cup Stand Drain

## 9. Operator's Tray

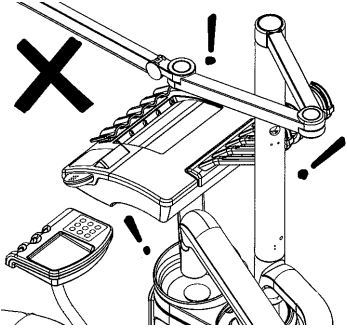
 <b>WARNING</b>	
	<p><b>Never set objects weighing more than 30N (3 kgf) on the tray table. Never set objects weighing more than 10N (1 kgf) on the auxiliary table. Do not use force to move the tray and do not subject it to bumps or other physical shocks.</b></p> <p>&gt;&gt; A load greater than 30 N could cause the tray to fall down resulting in bodily injury or equipment damage.</p>
	<p><b>Make sure the tray knob is properly adjusted.</b></p> <p>&gt;&gt; Otherwise, the tray could suddenly spring up or fall down resulting in an accident or equipment damage.</p> <p><b>Position the auxiliary tables of the dentist's swing table in their proper places so that they will not bump into the patient or any objects in the vicinity.</b></p> <p>&gt;&gt; If a table bumps into someone or something, it may cause an accident, damage or malfunctioning. (Ex: Over Arm Type B)</p>
	

Auxiliary table ※ : option

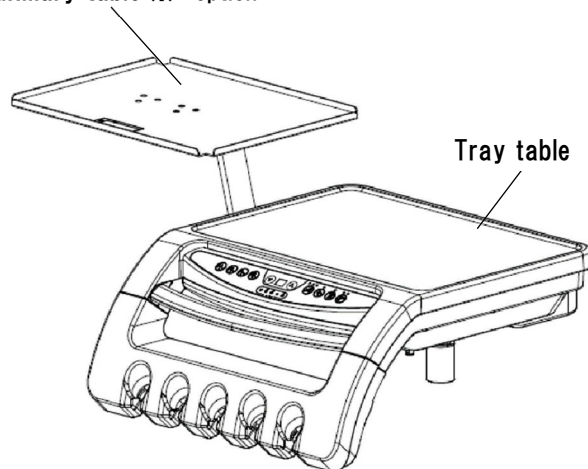



## (1) Over Arm 1) Operation

The tray can be rotated horizontally or lifted up and down. Grip the tray's handle and move it carefully.

\*There are some cases that specifications unavailable to be equipped depending on the country or region are inserted in this manual.

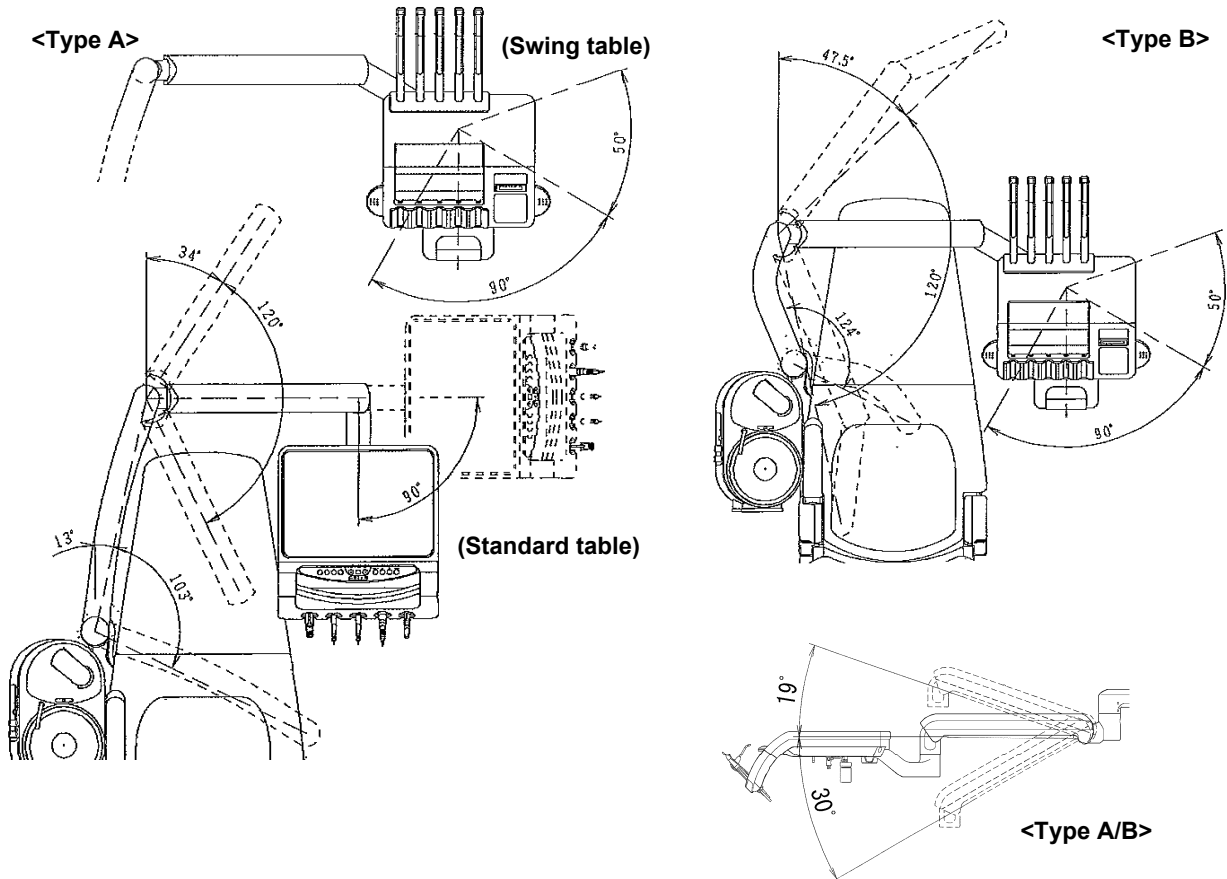

## 2) Adjust Action of Movable Arm

The action of the movable arm can be adjusted depending on how much weight is placed on the tray. Adjust it in the following way:

- For a heavy load (or to make the up and down action stiffer) Tighten the movable arm's knob to make its action stiffer and keep it from sagging up a heavyload. Tightening this knob completely will lock the arm in place and keep it from moving up and down.
- For light loads (or to make its action looser) Loosen up the knob for freer tray action.

### ADVICE

Keep a grip on the handle when loosening the knob. Otherwise, the tray could suddenly spring up if it was being held in a low position.

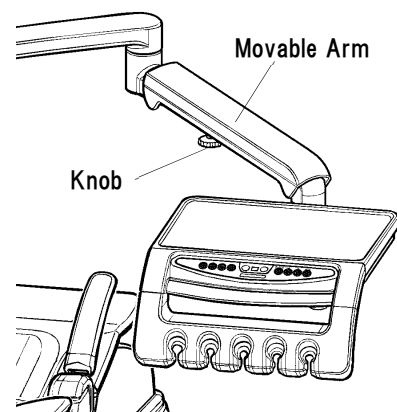

## (2) Interlock Switch

Normally interlock switch will turn OFF when using.  
 (its switch was been setting OFF before shipment at factory)  
 The following functions are disabled if it is switched over to the Lock position.

- >> Seat and Backrest Movement
- >> Instruments for operator's holder (except threeway syringe)

The pilot lamp on the switch side will light up while under lock.

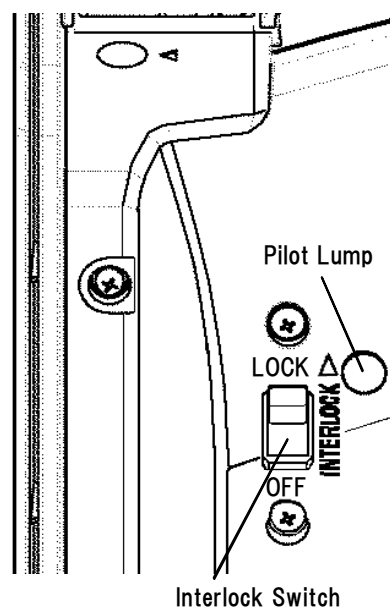
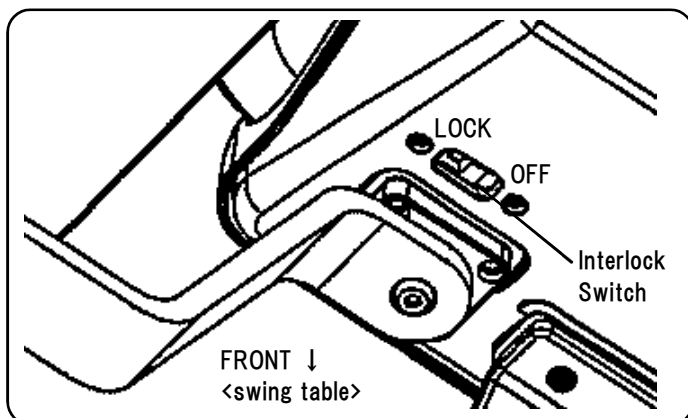

## (3) Tray handle

### 1) Table handle

Disinfect the handle by wiping it with ethanol.

### 2) Under handle\* (swing type)

Disinfect the under handle at the front of the dentist's swing table by wiping it with ethanol.

The under handle can be removed, and it supports disinfection (135°C) in an autoclave. Pull the knob part and remove it from the under handle frame. When re-attaching the under handle, align it correctly, and fit it into position.

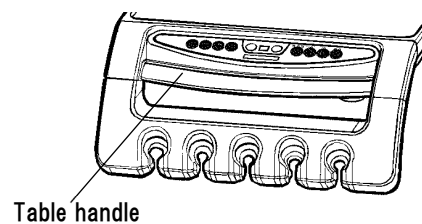
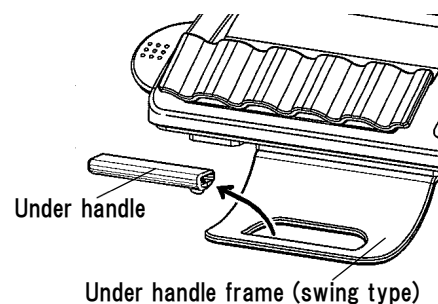

Table handle



Under handle frame (swing type)

### 3) Side handles (swing type)

Disinfect the side handles at both edges of the dentist's swing table by wiping them with ethanol.

The side handles can be removed, and they support disinfection (135°C) in an autoclave. Pull the side handles out, and remove them from the main unit.

When re-attaching the side handles, align them correctly, and fit them into position.

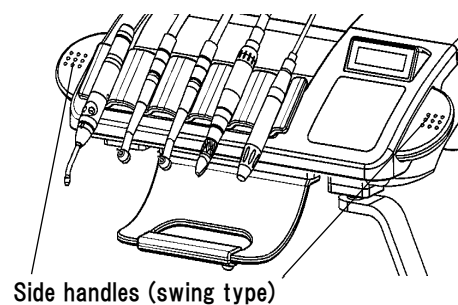

Side handles (swing type)

## (4) Auxiliary tables\* (swing type)

The auxiliary tables can be installed on the left side (patient's side), on the right side (dentist's side) or on both sides of the dentist's swing table.

The arm part and the table part rotate horizontally. Set them to the desired positions.

The specially designed silicone table sheets\* can be placed on the tops of the tables.

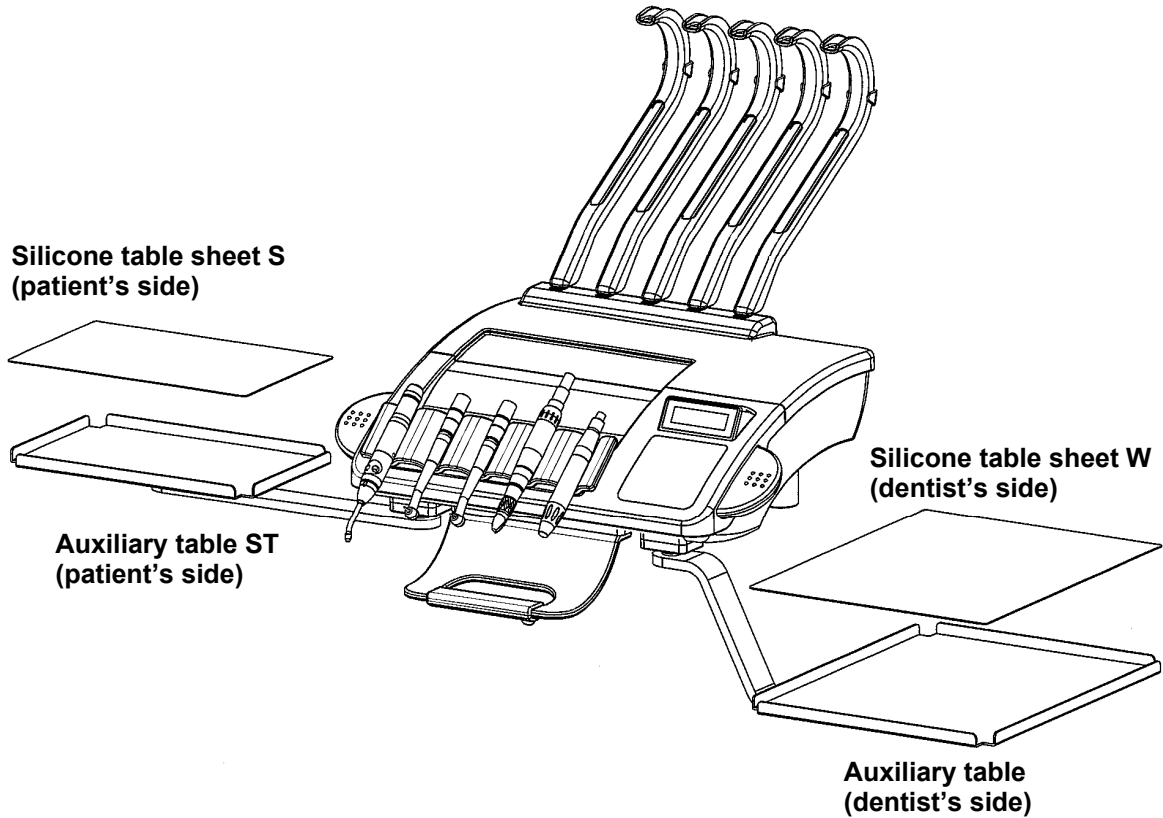

## (5) Contaminated Waste Container Stand

Stand for throwing the contaminated waste on the tray.  
Disinfection with ethanol and autoclaving (135°C) function.

### 1) Make Container

Use the special paper cup and cap which been attached. Put a cap on a paper cup to use as waste container.  
Line up the edge of the cup with groove inside the cap and press the cap down firmly.

### 2) Set Up

a) Install the waste container stand with waste container.  
Insert the waste container stand straightly under paper cup.

**ADVICE**

Make sure do not insert over strongly or slantingly, otherwise could resulted the shape change of paper cup.

b) Place it on the tray.

### 3) Replacement

Dispose of used cup in the specified, safe manner and replace it with a new one.  
Support the waste container stand and pull the paper cup out straightly.

**ADVICE**

Make sure do not hold the paper cup too hard, otherwise contents could dashes out.

When you run out of cups or caps, order a new supply from your local dealer or the J.MoritaCorp.

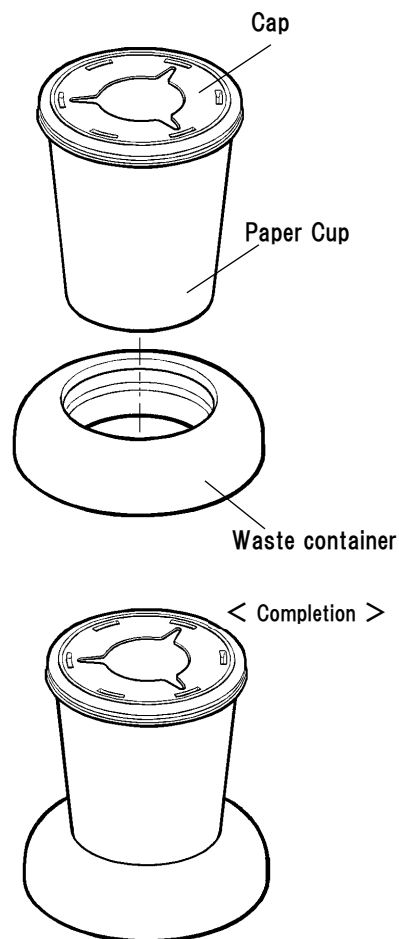

## (6) Tray Paper

Spread a sheet of this paper on top of the tray. Replace the paper whenever necessary. Contact your local dealer or the Morita Corp. for a new supply of paper.

## (7) Silicone Tray Mat\*

Lay this on top of the tray. This silicone Mat may be disinfected by wiping with ethanol or autoclave.

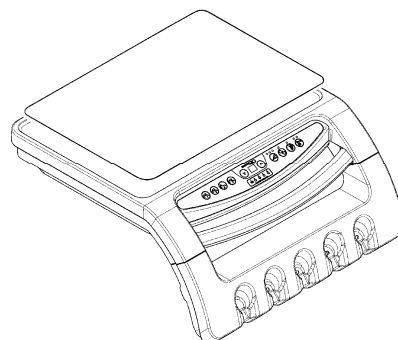

## (8) Silicone Medicament Bottom Stand\*

Place this holder on the tray to hold vials of medicine or other solutions. This holder may be disinfected by wiping with ethanol or autoclave.

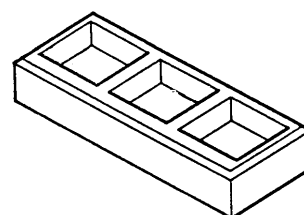

## (9) Contra Angle Handpiece Stand\*

Place on tray for holding micromotor contra heads and other attachments. This stand holds up to 7 attachments (ISO standard attachments for 40,000 min micromotors). Replace the oil absorbing pad whenever necessary. Contact your local dealer or the Morita Corp. for newpads.

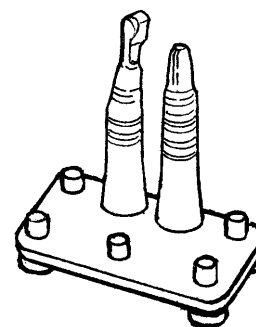

## (10) Switch Panel Cover\*

Disposable covers for the switch panel. Protect the panel from scratching and other damage. Available for both operator and assistant switch panels.

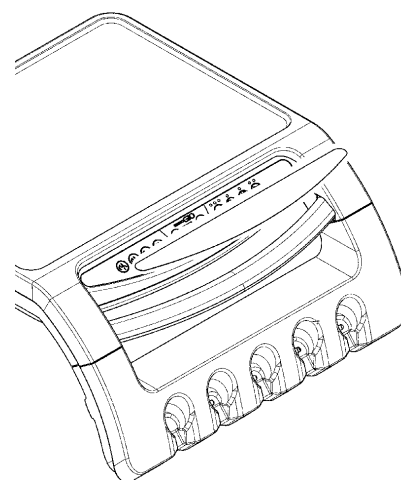

\* : Option

## 10. Film Viewer

Various film viewers can be used even after the main unit has been purchased and installed. (This depends somewhat on what other optional equipment is being used.) Contact your local dealer or the J. Morita Corp. to purchase a film viewer.

### (1) Multi-type Triple Viewer \*

Mounted on operator's tray to view dental, panorama, and 8"X10" films.

#### 1) Turn On and Off

Press the switch to turn the light inside the viewer on and press it again to turn it off.  
Slide the edge of the film under the retainer.

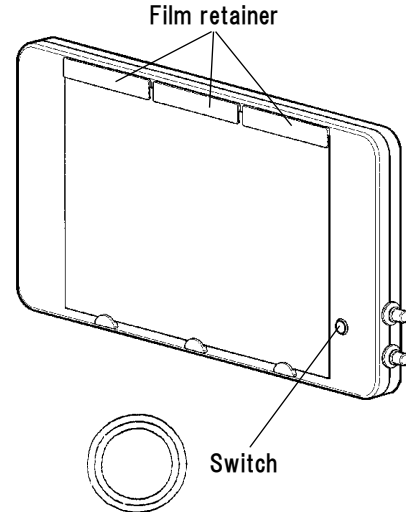

#### 2) Light Modes

The viewer has three lights depending on the type of film being viewed.  
Use the dial on the right side to change lights.  
"D" for dental Film.  
"P" for panorama film.  
"F" for full size (8x10 inch) film.

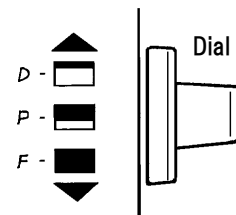

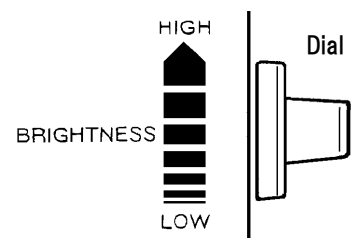

#### 3) Brightness Adjustment

The brightness for all three light modes can be adjusted.  
Use the dial on the right side to adjust the brightness from low to high.







\* : Option

## 11. Operating Light

 <b>WARNING</b>	
	<p><b>Do not bump or jar the light head or the light arm.</b>  <b>Do not get the light wet; if it happened to get wet, turn off the main switch and remove all moisture immediately with a dry cloth. Do not use the light until it is completely dry.</b>                      &gt;&gt; Otherwise there could be an accident resulting in bodily injury or equipment damage.</p>
	<p><b>Follow the directions and put the front cover on correctly and securely.</b>  <b>Replace the front cover immediately if it is discolored, deformed, cracked or otherwise damaged.</b>                      &gt;&gt; If the cover is not properly installed or damaged, it could fall off and cause a serious injury.</p>

## 12. Headrest

 <b>WARNING</b>	
	<p><b>Keep fingers, hair, clothes etc. away from the moving parts of the headrest.</b>                      &gt;&gt; An injury could result from fingers being pinched or hair etc. being caught in the moving parts.</p>
	<p><b>Adjust the headrest with non patient sitting.</b>                      &gt;&gt; Otherwise, it could result injury, damage on ratchet side, also sudden movement of the headrest could injure the patient's neck or head.</p>
	<p><b>Adjustment of headrest angle must operate by technician. Make sure the release button will not be press while supporting headrest without assistant's beside.</b>                      &gt;&gt; Otherwise it could suddenly fall down and this could result injure and damage.</p>
	<p><b>Support the headrest carefully to adjust its angle or push the slide bar in.</b>                      &gt;&gt; If the release button is pressed when the headrest is not supported, it could suddenly fall down and this could injure the patient. Also sudden movement of the headrest could injure the patient's neck or head.</p>

### (1) Slide Bar (standard)

The headrest slides in and out on a stepless continuum within a certain range.  
 Grip the headrest firmly in both hands and then slide it to an optional position.

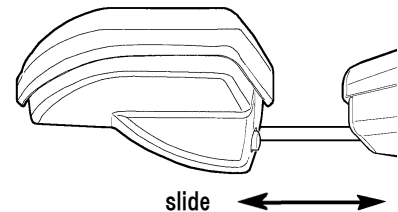

### (2) Angle Adjustment (standard)

Angle adjustment is possible within a certain range in following procedures.

>> **Up direction:** Push the headrest to the front, gripping it firmly in both hands. Fix it at an optional position.

>> **Down direction:** Press the release button, supporting the headrest in both hands. The headrest can be moved while the release button is pressed.

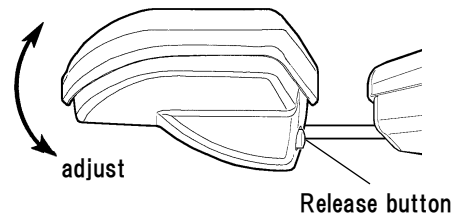



## 13. Armrest

### (1) Armrest on Assistant's Side\*

The armrest on the assistant's side is fixed in place and cannot be adjusted.

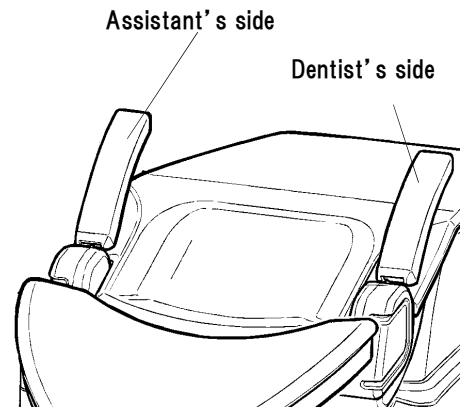





### (2) Movable Armrest on the Dentist's Side\*

<b>⚠ WARNING</b>	
<b>⊘</b>	<p><b>Keep fingers clear of the area where the dentist's arm-rest rotates. Also keep the instrument holder and any other equipment clear of the armrest.</b></p> <p>&gt;&gt; An injury could result from pinching the fingers.</p>

- 1) Raising and lowering the armrest on the dentist's side Lower the armrest to allow the patient to get in and out of the chair easily. When raised, the armrest is locked in position and will not move. To lower the armrest, pull up on it and swing it out and all the way down. To raise it, swing it back up. It will lock into position.

\* : Option

## 14. Display\*

 <b>WARNING</b>	
	<p><b>While arranging or moving, please be mindful of security while placing the unit on display. In particular, excise care that it does not strike the human body and that the torn arm is not subjected to any impact.</b></p> <p>&gt;&gt; Otherwise, an accident or injury may occur.</p>
	<p><b>The size and weight of a monitor that can be installed onto the machine are specified in the operation manual of the optional special tone arm that is sold separately. Please follow the written directions.</b></p> <p>&gt;&gt; Either of these actions could be dangerous or cause damage.</p>
 <b>CAUTION</b>	
	<p><b>When placing the unit on display, please follow the relevant regulations and agreement for the IEC60950 (Machine security information) and IEC60065 (security of electron machine) .</b></p> <p>&gt;&gt; Otherwise, leakage could be result in an accident or injury.</p>

It is possible to place a small screen display on the unit. In this case, a special tone arm\* will be necessary.  
 Additional parts can be installed after purchase. (However, additional cabling work will be necessary in this case.)  
 Please contact your local dealer or J.Morita Corp. for details about additional options.

### **CHECK**

Due to the size and weight limitations of the screen display, not all displays on the market can be used.  
 (The model may be specified in some cases)  
 Please contact your local dealer or J.Morita Corp. for details.

### (1) Arm Operation

Joints can be moved and an optional base added if put on special display. Please follow the directions in the manual.

### (2) Display Handling

Please follow the directions in the manual.

## 15. After Use

<b>⚠ WARNING</b>	
<b>!</b>	<p><b>Turn off the main switch whenever the unit is not being used.</b>                      &gt;&gt; This will prevent various types of potential problems such as fire or accidents due to electrical leakage or water leakage or both.</p>
	<p><b>Before plugging the unit back in and opening the air and water valves, make sure all the wiring and tube connections are properly made.</b>                      &gt;&gt; Otherwise, there is a risk of accidents and malfunctions due to shorts, overheating, water leakage etc.</p>
<b>⊘</b>	<p><b>Never let electrical plugs and receptacles get wet, and never allow dust to collect on them. If a plug or receptacle gets wet, immediately unplug the unit, and completely dry the plug or receptacle before using the unit. If dust has collected on a plug, unplug the unit and carefully clean off all the dust with a dry cloth etc.</b>                      &gt;&gt; Shorts, or overheating caused by wet or excessively dusty plugs can result in accidents such electric shocks and fires and equipment damage.</p>
<b>⚠ CAUTION</b>	
<b>!</b>	<p><b>Turn off the water valve after medical treatment. And also turn off the air valve when on extended shut-down period, or injury/damage been found.</b>                      &gt;&gt; Shorts, or overheating caused by wet or excessively dusty plugs can result in accidents such electric shocks and fires and equipment damage.</p>
	<p><b>Follow the safekeeping condition as below to keeping it.</b></p> <ol style="list-style-type: none"> <li>1) Temperature: -10~70C</li> <li>2) Humidity: 10~85%RH (no not be dewy)</li> <li>3) Air pressure: 700~1060hPa</li> <li>4) Do not tilt the equipment or place it in an unstable position; do not expose it to excessive vibration of physical bumps or shocks.</li> <li>5) Do not install the equipment in areas where it will be exposed to excessive atmospheric pressure, humidity, temperatures, wind, direct <b>sunlight, dust, salts or sulfur compounds.</b></li> </ol> <p>&gt;&gt; Otherwise, there is a risk of malfunctions and damage.</p>

### (1) After Use

Turn off the main switch when you are finished using the unit.  
 Close the water valve at the side of the plumbing pit after treatment.  
 Turn the lever upright to the maximum.

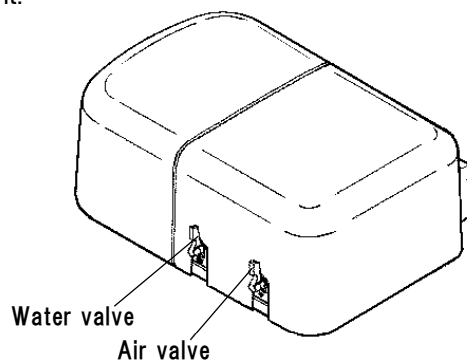

## (2) For Extended Shut-down Periods

When the unit will not be used for an extended period of time, or in cases when it is not working properly, turn off the main switch and close the main water valve.

Follow the procedure below.

**<Be sure to turn off the water when undertaking the following procedures or when the following conditions exist>**

- >> If the auto filler does not turn off
- >> To replace the bacteria filter
- >> When water is leaking from the unit
- >> If the chair is malfunctioning and needs repair
- >> In case of earthquakes, fires, etc.

1) Turn the main switch off.

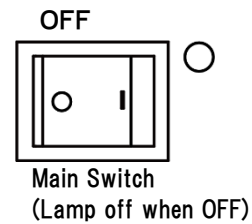

2) Close the water valve for the plumbing pit.

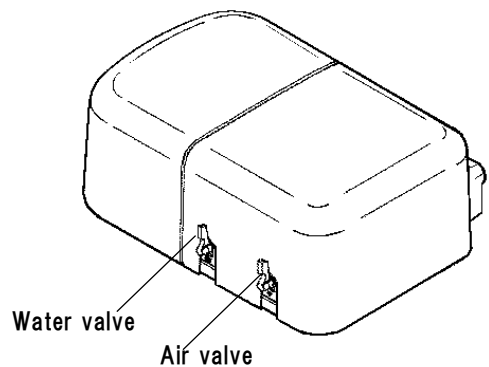

3) Reverse the above procedures to start using the unit again.

## 16. Fuses

<b>⚠ WARNING</b>	
<b>!</b>	<b>Before replacing fuses, always turn off the main switch.</b> >> Otherwise, you could get an electrical shock or some other type of accident resulting in bodily injury or equipment damage.
	<b>Whenever a fuse blows, this indicates the possibility of some problem with the electrical circuitry and the unit should be inspected as soon as possible. Contact your local dealer.</b> >> Continued use could result in accidents or malfunctions due to electrical leakage or some similar problem.
<b>⚠ CAUTION</b>	
<b>⊘</b>	<b>Always replace fuses with ones of the same type and capacity.</b> >> Using the wrong type Sof fuse or a substitute such as a piece of wire can result in damage to the equipment due to the wiring overheating and burning.

### (1) Replacing Fuses

The main fuses are located at the position of the right illustration.

Follow the procedure below to replace fuses. Use a medium sized Phillips screwdriver.

< Fuses Disposition >

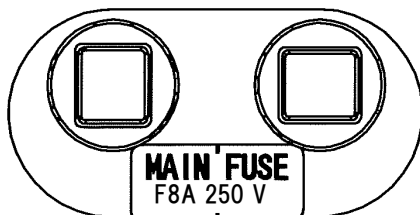

- 1) Turn the main switch off.
- 2) Loosen the screw of the front cover on the fuse holder with a medium- sized Phillips screwdriver. Take out a blown fuse and replace it with a new one.
- 3) Tighten the front cover on the fuse holder.

#### **CHECK**

If the fuse blows again, there could be a problem with the wiring. In this case, stop using the unit and turn the main switch off. Then contact your local dealer or the J.Morita Corp. to have the unit inspected.

- 4) If the unit does not work normally after the main fuse is replaced, there could be a problem with a fuse in the body. In this case, stop using the unit and turn the main switch off. Then contact your local dealer or J. Morita Corp. to have the unit inspected.

<Chair Base>

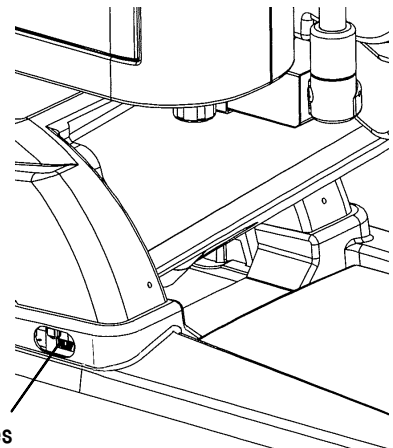

Fuses

<Chair Base>

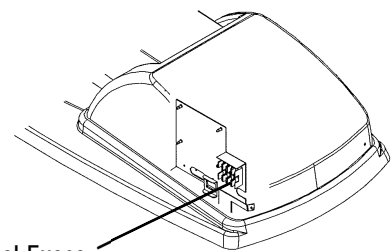

Internal Fuses

## [6] Maintenance

 **WARNING**

	<p>Be sure to turn the main switch OFF when caring for/cleaning the main unit. Close the water supply valve and air supply valve as necessary.                  &gt;&gt; Accidents and faults due to unforeseen circumstances/electric shock etc. may occur.</p>
	<p>Be sure to wear rubber gloves when caring for/ cleaning the main unit to prevent infection.                  &gt;&gt; An infection within the clinic may occur.</p>
<p></p>	<p>Sterilize and properly wipe successive parts such as each instrument that come into contact with the oral cavity.                  &gt;&gt; If proper sterilization and wiping are not carried out suitable hygiene management is not employed, a nosocomial infection may occur.</p>
	<p>When using equipment such as an autoclave, follow the operation instructions for each device. Use the following temperatures corresponding to the sterilization regulations.                  &gt;&gt; Damage / faults both sterilized materials and equipment and an accident may occur.</p>

 **CAUTION**

<p></p>	<p>When working inside the basin unit, do not touch the warmer tank or other components that could be hot. Also, do not components inside the housing of the chair unit.                  &gt;&gt; There is a risk of burns or other injuries. The main power turns off when the basin unit door is opened.</p>
--	---

## Everyday Maintenance (before treatment)

### 1. Flushing Out the Water System

#### ⚠ CAUTION



Once a day, before commencing treatment, drain residual water from the main unit using the following procedure.

Take particular care after if the water has been there for a longer period, such as the day after a holiday.

>> Since a certain amount of water remains in the warmer tank and tubes of the main unit and the quality of water will decrease if it is left for a long period, the remaining water should be discharged before use.

Before commencing daily treatment, drain residual water from the main unit from each water line.

Turn on the main switch and follow the procedure described below.

#### (1) Manual Flushing

Flushing can also be performed manually.

##### CHECK

Do not fail to start from step 1 and follow the procedure exactly; otherwise the flushing procedure will not be performed efficiently.

##### ADVICE

The times for flushing each system (see chart to the right) are predicated on the amount of water in the system.

Longer flushing times are recommended to include the water in the main line leading to the treatment unit.

Estimated Flushing Times	
System	Time
Auto Filler	1 min
Three-way Syringe	
Air Turbine	
Micromotor	2 min
Ultrasonic Scaler	3 min

#### 1) Auto Filler Flushing

- Put a cup in place and fill it.
- Empty the cup and refill it. Repeat 8 times.
- The manual cup switch can also be used. In this case hold the switch down for 1 minute.

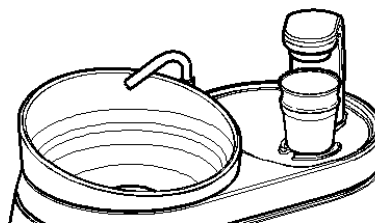

#### 2) Three-way Syringe Flushing

- Do both the doctor's and the assistant's at the same time.
- Hold the nozzles over the basin and run water through the syringes for at least 1 minute.

#### 3) Air Turbine

- Take the handpiece out of its holder and turn on the spray switch.
- Take the handpiece off its main tube.
- Hold the end of the tube over the basin and step on the foot pedal. Run water through the tube for at least one minute.
- Finally reconnect the handpiece and return it to its holder. Repeat the above procedure for the second handpiece.

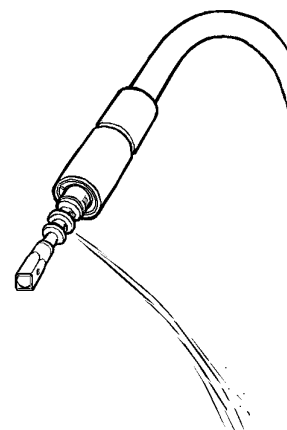

## 4) Micromotor

- a) Take the motor out of its holder and turn its spray switch on.
- b) Connect an attachment that has a sprayfunction.
- c) Hold the attachment over the basin and step on the foot pedal.  
Run water through the motor for at least 2 minutes.

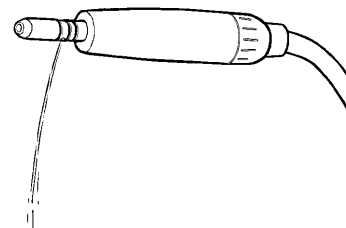

### CHECK

Outlet for water of the micromotor is on the side of the connection cylinder. Let the water spout after confirming the position of the outlet.

- d) Finally return the motor to its holder.  
Repeat the above procedure for the second micromotor\*, if the unit is equipped with one.

## 5) Ultrasonic Scaler

### ⚠ CAUTION



The handpiece must always be attached before the scaler is vibrated.  
>> Otherwise, excessive loads will be applied to the circuit board and other components, and this could result in a breakdown or other malfunction.

- a) Take the handpiece out of its holder and turn on the spray switch.
- b) Hold the handpiece over the basin and step on the foot pedal.  
Continue to operate the instrument for at least 3 minutes.
- c) When flushing is completed, return the handpiece to its holder.

### CHECK

Wipe moisture off enough for corrosion and prevention after confirm the abnormality from O-ring, if handpiece connector leakage.



## (2) Using the Flushing Device\*

Set up the flushing device and flush out the various systems.

### 1) Flushing Device \*

This is used to flush out all the water lines inside the unit. Do this once a day.

Switch On the main switch and follow the direction in the display.

- a) Set the flushing bowl up on the basin. Line up and fit the gauge on top of the bowl to the end of the auto filler for correct positioning.

#### ADVICE

There is a magnet in the bottom of the bowl, and a sensor detects whether the bowl is correctly positioned.

When the bowl is in the correct position, the auto filler stops running.

- b) An inside magnet switch detects the flushing device, and then the flushing preparation mode boots up automatically.

#### CHECK

Once the body detects the flushing device, the flushing lamp on the assistant's switch panel lights up. Seeing the flush lamp light up, you can confirm that the flushing device is set up on the basin properly.

- c) Connect the main tubes to the flushing bowl.  
Do not fail to connect the tubes in the order shown in the chart at the right and matched to their mates labeled on the bowl.  
Fix the water lever for the threeway syringe so that it is held down. There is a device on the bowl to do this.

Flushing Bowl

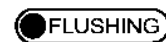
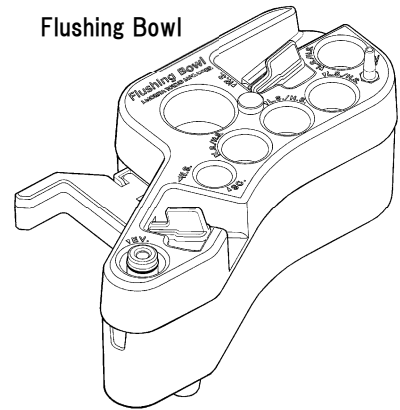

Flushing Lamp



Flushing Switch

Flushing Bowl Connections

Instrument	Main Tube Set Up
H.S.	Disconnect Hand piece
L.S.	Disconnect Attachment
SC.	Take Tip Off
EV.	
S.E.	Take nozzle off
W.S.	

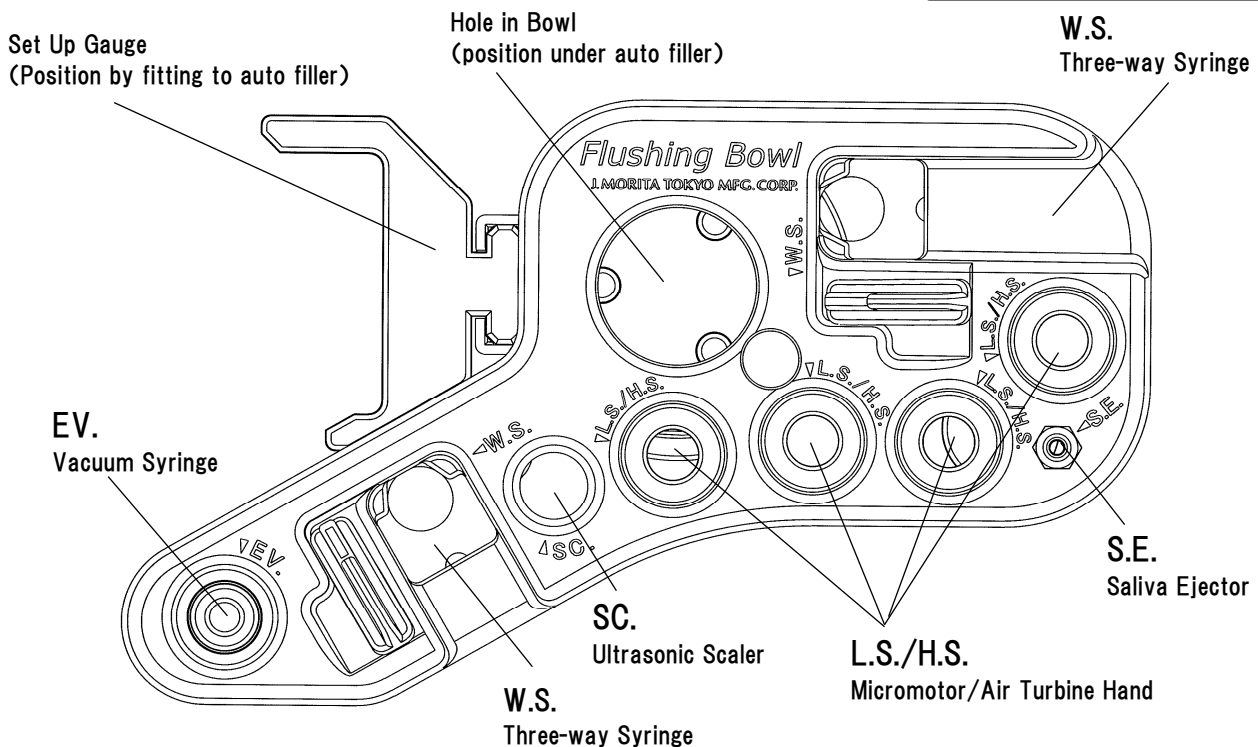

c) After connecting all the tubes, press the flushing switch. The flushing procedure will be performed automatically. It takes approximately 6 minutes.

Switch lamps will light up to show the progress.

### <Stages>

Stage 1: Three-way water flows (continues to end of procedure)  
Stage 2: Basin water flows (approximately 30 seconds)

Stage 3: Water flows from auto filler and vacuum and saliva ejector are activated (approximately 30 seconds)

Stage 4: Water flows from instrument tubes (approximately 30 seconds)

Stage 5: Repeat stages 3 and 4 above 4 times.

Stage 6: Vacuum and saliva ejector are activated (approximately 15 seconds)

d) The lamp above the switch goes out when the procedure is finished. Disconnect all the tubes and put them back in their holders.

### ADVICE

Be sure to release the retainer holding down the water lever on the three-way syringe. Something could be damaged if the tube is pulled off without doing this first.

e) Take the flushing bowl off the basin.

### CHECK

Most of the water inside the device is removed by the vacuum and saliva ejector, but a little may be left. If so, pour it out before putting the device away. If considerable water is left in the bowl, drain it out through the drain hole.

f) Take Bowl Apart

The top and bottom of the bowl can be taken apart for cleaning. Loosen the screw in the middle of the bowl.

### ADVICE

Do not tighten the screw too much when putting the bowl back together. This could damage it.

 Flushing Lamp



Flushing Switch

Flushing Lamp

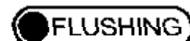

Bowl set up : Lamp on  
Flushing : Lamp Blinks  
Take Bowl : Lamp Off

Spray Switch

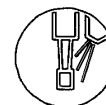

Stage1 ~ 3,6: Amber Lamp Blinks  
Stage4: Green Lamp Blinks  
Finished: Amber Lamp

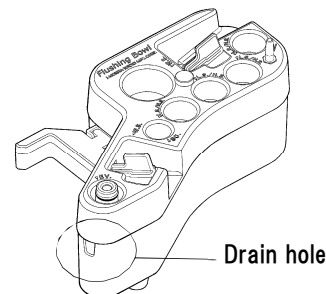

Drain hole

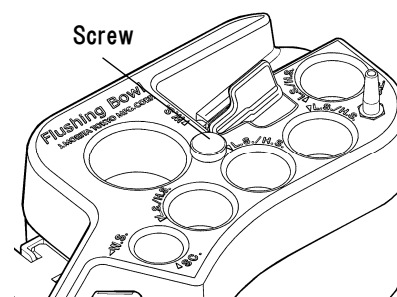

Screw

## Everyday Maintenance (between patients)

### 1. Vacuum System Rinsing

Flush the vacuum syringe and the saliva ejector piping with tap water.

If the inside of the vacuum tube becomes dirty, loss of suction power, failure, clogging etc. may occur.

#### (1) Inside of Main Tube for Vacuum Syringe and Saliva Ejector

Use the procedure below to clean these tubes after finishing with each patient:

- 1) Turn main switch on.
- 2) Take the vacuum syringe and saliva ejector off their holders on the assistant's side and suck up one or two cups of water.  
Same time, take action while the valve lever in closing situation and open the lever slowly to vacuum.
- 3) Return the instruments to their holders.

#### (2) Vacuum Tank Auto-cleaning System

This system cleans the vacuum tank with both air and running water. Do this between patients.

- a) Press the vacuum auto-cleaning switch on assistant's switch panel to perform auto-cleaning.
- b) Cleaning will terminate automatically after the specified time has elapsed. To stop it sooner, press the auto-cleaning switch again.
- c) After cleaning has finished, rinse the basin with approximately 2 cups of water.



Vacuum Tank  
Auto-cleaning Switch

Everyday Maintenance (after use)

1. Cleaning the Cut Filters

**CAUTION**



**When installing the vacuum filter, be sure it is fully inserted.**

>> If the vacuum filter is not fitted properly, the performance of the vacuum syringe/saliva ejector may be adversely effective, or a malfunction/clogging etc. may occur.

Follow the procedure below to clean the cut filter (2 places) at least once a day:

- 1) Take the cut filter off the unit.  
Pick the cap head and then unscrew it slowly.
- 2) Separate the cap and the cut filter and then clean each with running water.
- 3) Put the cut filter and the cap together and then put those ones back to the unit. Insert the cap firmly and let each knob vertical.

**ADVICE**

Apply Vaseline to the O-ring at the side of the cap so that the cap goes in and out smoothly.

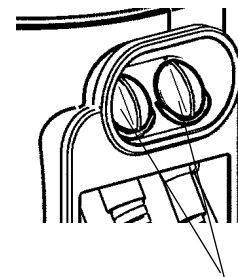
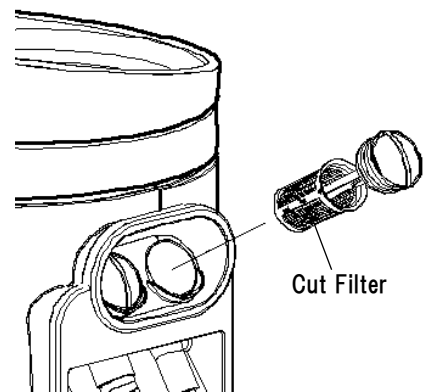

The switch shown length way

## 2. Cleaning the Basin

### ⚠ CAUTION



When cleaning the basin, do not use detergents containing abrasives, or hard cleaning materials such as a scourer/steel wool. Do not strongly rub it.  
>> Damage, scratching, and discoloration may occur.

### (1) Take Off Basin and Basin Nozzle

The basin and its nozzle can be taken off for cleaning.

a) Turn the main switch off.

#### ADVICE

If the main switch is on, the sensor for the auto filler will be activated and water will splash around the area.

b) Take off the basin nozzle.

Hold the basin down and pull the nozzle straight up.

c) Take basin off.

Put your fingers in the gap between the basin and the top of the basin unit and ease the basin up slightly. Then press down on the top of the unit and pull the basin straight up and off.

d) Reverse the order of the steps above to reassemble.

Line up the indentation on the bottom of the basin with the projections in the top of the basin unit and carefully push the basin back into place. Line up the pin on the nozzle with the groove inside the basin and slide the nozzle all the way back into place.

#### CHECK

If the basin is not put back properly, the nozzle will not go back in. Ensure the indentations and projections on the bottom of the basin are correctly line up.

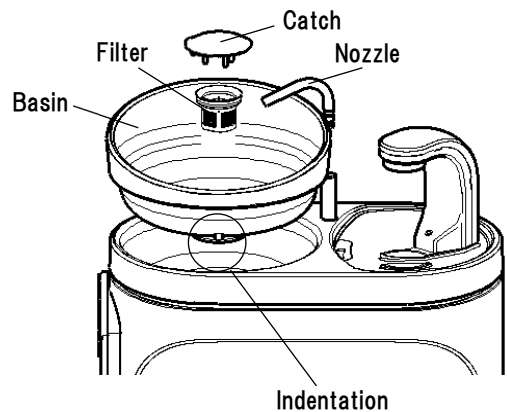

## (2). Cleaning the Basin Filter

Use the following procedure to clean the basin filter at least once a day:

- 1) First remove the catch and then take out the filter.
- 2) Wash the filter and catch in running water.
- 3) Reverse the above steps to replace the filter and catch in their original positions.  
Make sure the filter goes all the way in.

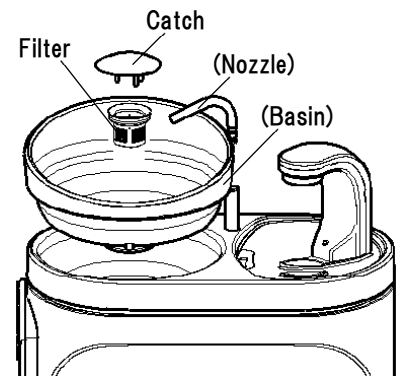

## (3) Cleaning the Basin

Clean the inside and surrounding surfaces of the basin everyday or as frequently as necessary.

- 1) Use a sponge or soft cloth to apply the cleaner provided or a neutral detergent or disinfecting ethanol.
- 2) Wipe the surface with a dry cloth to dry it and remove the cleaner or detergent.

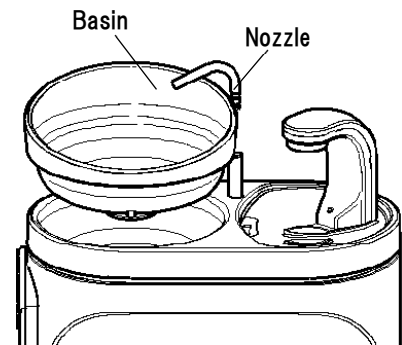

## 3. Rinsing the vacuum piping with cleanser

<b>⚠ CAUTION</b>	
<b>!</b>	<p>Use only cleaners recommended by the J.Morita Corp. and follow the instructions that come with the product.</p> <p>&gt;&gt; Using inappropriate products or methods can damage tubes or other components and result in malfunctions, water leakage, loss of vacuum power and other problems.</p>









Rinse vacuum syringe and saliva ejector piping with cleanser.

If the inside of the vacuum tube becomes dirty, loss of suction power, failure, clogging etc. may occur.

Use the vacuum system cleaner recommended by the J.Morita Corp. Follow the instructions that come with the cleaning product.

Maintenance as Required

1. Cleaning Other Components and Surfaces

 <b>WARNING</b>	
	<p>Do not leave moisture, detergent, ethanol etc. on the main unit surface or inside the device.</p> <p>Do not allow moisture to adhere inside and do not do anything that could cause water to enter the unit such as directly wetting the panel switches and automatic filler.</p> <p>In the event that water does adhere, turn the main switch OFF, wipe thoroughly with a dry cloth etc. and dry thoroughly before reuse.</p> <p>&gt;&gt; Accidents such as fire due to a short circuit, discoloration / deterioration/malfunction/faults may occur.</p>
 <b>CAUTION</b>	
	<p>When cleaning each part of the main unit, do not use a cleaning agent other than the supplied cleaning agent (or neutral detergent).</p> <p>&gt;&gt; If you use chemical wipes, cleaning products impregnated with chemicals or items containing cleansers besides disinfectant ethanol (benzene, thinners etc.), it may adversely affect the unit, causing discoloration, degradation and faults.</p>
	<p>Do not apply wax and solvents designed for use on floors to the housing / foot control etc. In the event that a product does adhere, wipe it off promptly.</p> <p>&gt;&gt; If the product is left it may cause discoloration/deterioration / faults.</p>
	<p>When cleaning the main unit, do not spray water, cleaning agent etc. directly on the main switch.</p> <p>&gt;&gt; This may cause a fault.</p>
	<p>If chemicals adhere to resin parts such as the instrument holders or tray surfaces, wipe them off immediately using a soft cloth with a little disinfectant ethanol. Do not allow ethanol to enter inside the main unit.</p> <p>&gt;&gt; Leaving chemicals adhering may cause discoloration or deterioration.</p>
	<p>When cleaning the automatic filler, be careful not to allow foreign matter such as lint to enter into the notch in the sensor.</p> <p>&gt;&gt; Contamination may cause a malfunction.</p>

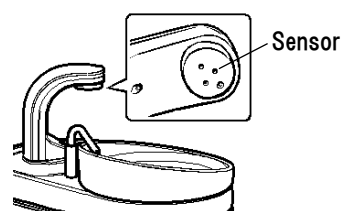







2. Other Components and Surfaces

Clean as frequently as necessary.

Refer to section [5] Operation in this manual for how to detach various components for cleaning.

- 1) Add water, the supplied cleaning agent, neutral detergent, or disinfectant ethanol to a soft cloth, sponge etc. and wipe it off .
- 2) Then, wipe with a dry cloth, taking care not to leave any residual moisture or detergent.

## Wiping with Disinfectant Ethanol

 <b>WARNING</b>	
	Clean the equipment in a suitable manner before disinfection. >> Insufficient sterilization may occur.
 <b>CAUTION</b>	
	Use only was disinfecting ethanol(76.9-81.4vol%). >> Other kinds of alcohols can cause discoloration or damage the material.
	When cleaning with ethanol, please avoid the areas where ethanol may ingress such as the gaps around joint / rotation axes / switches. Do not use excessive ethanol for other parts. >> Accidents due to a short circuit, degeneration, deterioration or damage may occur.
	After cleaning with ethanol, do not place with other products (for example, do not put a mouse pad on the silicone tray sheet). Dry thoroughly and store separately. >> Color transfer from other products, deterioration may occur due to the effects of ethanol.

Disinfect various components and surfaces by wiping with ethanol before and after treatment or as frequently as necessary.

See the list for components and surfaces that should be disinfected by wiping with ethanol.

Refer to section [5] Operation of this manual for how to detach components for cleaning.

### 1. Wiping the Parts

- Instruments
- Instrument tube
- Operating Light Handle Cover, Operating Light Cover and Reflector  
NOTE: For details of the wiping method, refer to the operation instructions for the product.
- Basin, Basin Catch, Fountain Nozzle
- Top cover of Dentist's Holder
- Table handle
- Contaminated Waste Container Stand
- Silicone Medicament Bottle Stand
- Silicone tray Sheet
- Contra Angle Handpiece Stand \*1
- Dentist's & Assistant's switch panel
- Armrest (both standard and optional armrests)
- Leather for Headrest, Backrest and Seat



## 2. Wiping procedure

Refer to the following procedure.

After use → Cleaning → Rinse and dry → Disinfection

- 1) Rinse and dry after cleaning the equipment.

How to clean : Hand cleaning

Water to use : Drinking water / Water temperature : 25 - 35°C

- 2) Wipe with a soft cloth such as gauze containing a small amount of disinfectant ethanol.
- 3) Then wipe dry with a dry cloth so that no moisture remains.

**ADVICE**

Wring out the cloth so it does not contain an excessive amount of disinfectant ethanol.

## 3. Instrument Wiping

Wipe with disinfectant ethanol before and after treatment if necessary.

For details of the wiping method, refer to the operation instructions of the product.

- Air Turbine Handpiece
- Micromotor Attachments
- Micromotor Motor Cover
- Ultrasonic Scaler Tips and Body
- How to remove the syringe body and nozzle of the threeway syringe (WS97 / WS90P)  
→ p37
- How to remove the syringe body, VS nozzle and VS tip of the vacuum syringe (VS110)  
→ p38
- How to remove the ejector body and SE flexible nozzle the saliva ejector (SE110)  
→ p38

## 4. Leather Seat and Backrest Surfaces

**⚠ CAUTION**



**Do not subject the leather seat to the following conditions.**

- 1) Contact with clothing and bags containing dyestuff s such as real leather and denim  
(risk of discoloration due to color transfer/degeneration)
  - 2) Contact with vinyl/styrene/ABS/wood products/painted products  
(risk of discoloration and degeneration/cracks)
  - 3) Contact with printed materials such as newspapers and magazines/printed pattern fabrics  
(risk of color transfer and disfiguration)
  - 4) Contact and use of solvents/paints/chemicals/adhesives/adhesive tapes etc.  
(damage and deformation/discoloration/degeneration/hardening/softening)
  - 5) Use of bleach  
(risk of discoloration and degeneration)
  - 6) Contact with or proximity to a heat source such as an iron or a stove  
(damage and deformation/discoloration/degeneration)
  - 7) Partial loading due to being pressed against, scuff ed, etc.  
(damage and deformation/discoloration/degeneration)
- >> This may cause damage/degeneration/discoloration etc. of the leather seat or other parts.

- 1) Wipe using a soft cloth or sponge containing a small amount of disinfectant ethanol, the supplied cleaning agent, a neutral detergent, or water.
- 2) Then, wipe with a dry cloth, taking care not to leave any residual moisture or detergent.

Depending on the color, some leather seat and backrest covers may not be disinfected with ethanol. If necessary, leather coverings can be replaced for a standard fee. Contact your local dealer or the Morita Corp. for details.

Autoclave Sterilization

 **WARNING**

	Clean the equipment in a suitable manner before sterilization. >> Insufficient sterilization may occur.
	The recommended autoclave sterilization conditions described in these operation instructions do not guarantee sterility. Always carry out sterilization validation by yourself. >> An infection within the clinic may occur.

 **CAUTION**

	When autoclave sterilization is carried out, put items in a mesh basket, tray, sterilization pack etc. so that the sterilized material does not directly come into contact with the inner walls of the chamber. For models with high drying and standby temperature, remove the chamber promptly when sterilization is not being carried out. >> Instruments can be damaged by making contact with the interior walls of the sterilization chamber and by excessively high temperatures.
	Perform regular maintenance of the sterilizer. >> Lead to a drop in performance.
	If abnormalities such as deformation, degeneration, cracks etc. are found among sterilized sites, stop using the part and replace it with a new one. In particular, the resin products of the vacuum syringe and VS nozzle and SE flexible nozzle of the saliva ejector will be consumed faster than parts made of metal/silicone due to repeated sterilization. >> The inner wall of the chamber and the drying process may reach a higher temperature than the set sterilization temperature and damage to the sterilized material may occur.

### 1. Sterilization the parts

- Instruments
- Operating Light Handle Cover  
NOTE: For details of the wiping method, refer to the operation instructions for the product.
- Contaminated Waste Container Stand
- Silicone tray Sheet
- Silicone Medicament Bottle Stand

### 2. Sterilization procedure

Perform autoclave sterilization before and after treatment if necessary.

Refer to the following procedure.

After use → Cleaning → Rinse and dry → Sterilization and dry

- 1) Rinse and dry after cleaning the equipment.  
How to clean: Hand cleaning  
Water to use: Drinking water / water temperature : 25-35°C
- 2) When autoclave sterilization is carried out, put items in a mesh basket, tray, sterilization pack.

When using equipment, follow the operation instructions for each device.

- Sterilize with steam sterilization (autoclave) according to ISO17665-1.

### 3. Instrument Sterilization

Perform autoclave sterilization before and after treatment if necessary.  
 Refer to section [5] Operation of this manual for how to detach components for cleaning.  
 For details of the autoclave sterilization method, refer to the operation instructions of the relevant product.

- Air Turbine Handpiece
- Micromotor Attachments
- Micromotor Motor Cover
- Ultrasonic Scaler Tips and Body
- How to remove the syringe body and nozzle of the threeway syringe (WS97 / WS90P)  
 → p37
- How to remove the syringe body, VS nozzle and VS tip of the vacuum syringe (VS110)  
 → p38
- How to remove the ejector body and SE flexible nozzle the saliva ejector (SE110)  
 → p38

Sterilization Part	Temperature	Time
Vacuum Syringe VS110 Body and Tip	134 ± 1°C	10 mins above
Saliva Ejector SE110 Body and Nozzle	134 ± 1°C	10 mins above
Three-way Syringe WS201 Nozzle (when resolve)	134 ± 1°C	10 mins above
Three-way Syringe WS97/WS90P Body and Nozzle (when resolve)	134 ± 1°C	10 mins above

Autoclave sterilization of the threeway syringe, vacuum syringe, and saliva ejector is carried out by removing the nozzle and tip from the main part.

### 4. Other Sterilization

Perform autoclave sterilization before and after treatment if necessary.  
 Refer to section [5] Operation of this manual for how to detach components.

Sterilization Part	Temperature	Time
Contaminated Waste Container Stand	134 ± 1°C	5 mins above
Silicone tray Sheet	134 ± 1°C	5 mins above
Silicone Medicament Bottle Stand	134 ± 1°C	5 mins above
Holder Cover (Swing type operator' s tray)	134 ± 1°C	5 mins above
Under Handle (Swing type operator' s tray)	134 ± 1°C	5 mins above
Side Handles (Swing type operator' s tray)	134 ± 1°C	5 mins above

## Other Methods of Disinfection and Sterilization

### CAUTION

	<p><b>Do not dry heat (with dry sterilizer)/sterilize the various parts of the main unit.</b></p> <p>&gt;&gt; Discoloration/deterioration/faults may occur due to the high temperature.</p>
	<p><b>Do not soak, rinse, or boil any part of the main unit with a cleanser containing disinfectant ethanol or solvent (such as benzine or a thinner).</b></p> <p>&gt;&gt; Discoloration/deterioration/faults may occur.</p>

Other sterilization/disinfection methods may have adverse effects on the main unit and parts. Consult your reseller or the nearest MORITA CORP. subsidiary in advance.

Once a Month

1. Vacuum Tank Inspection and Cleaning

<b>⚠ CAUTION</b>	
<b>!</b>	<p><b>Use the procedure to inspect and clean the vacuum tank at least once a month.</b></p> <p>&gt;&gt; Otherwise, the equipment could malfunction, water leakage, its performance could deteriorate, or lines could become plugged.</p>
	<p><b>After cleaning make sure the vacuum tank and its flexible drain tube are properly and securely installed and connected.</b></p> <p>&gt;&gt; Otherwise, the performance of the vacuum syringe or saliva ejector could deteriorate, these instruments could malfunction or their lines could get plugged up.</p>

Use the procedure below to inspect the vacuum tank at least once a month and clean it if necessary. This is not necessary if the unit is not equipped with a vacuum tank or an air vacuum.

- (1) Switch OFF the main switch and open the door.
- (2) Disconnect the drain tube (2) which connected with tank holder.  
Press the lock lever and take off the tube.

**ADVICE** Prepare some towels in case the water running out from the tube.

- (3) Disconnect the drain tank and tankholder.  
Press the lock lever on right side, hold the handle and take off the knob.

**ADVICE** Watch out for water running out when disconnects the tank.

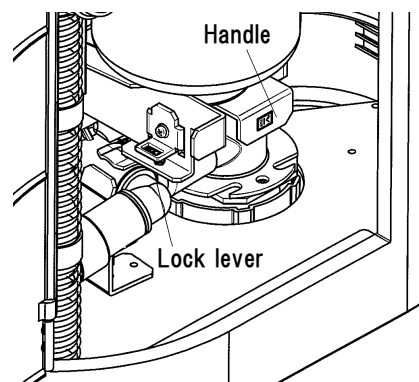
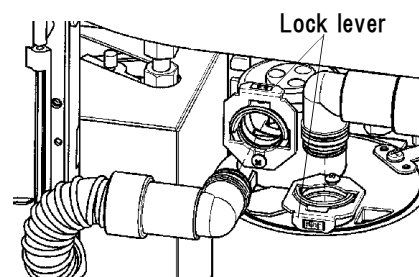

(4) Turn the tank to free it from its holder. Turn the tank to the left until the tab on the holder comes free and then pull the tank down to take it off.

(5) Wash the tank in wall with running water.

(6) Wash the bottom of vacuum tank and the valve plate with running water.  
Loosen the thumb screw to take off the bottom of vacuum tank, and then clean both faces of the valve plate and inner wall of the bottom of tank.

(7) Wipe each part well after finishing cleaning.

**ADVICE**

Connecting a wet part into the inside of the unit will cause trouble and rust.

(8) Put the bottom of vacuum tank back to the vacuum tank.  
After fixing the valve plate to the vacuum tank, insert the bottom of vacuum tank to the vacuum tank, and then fix it with the thumb screw.

(9) Put together the tank holder and the vacuum tank into an original form. After fitting the tank holder and the vacuum tank well, rotate it clockwise until the tab on the side of the tank holder is secured to the vacuum tank.

**ADVICE**

Apply Vaseline to the O-ring at the side of the tank holder if the tank holder does not fit the vacuum tank well.

(10) Connect the assembly of the vacuum tank and the tank holder to the unit.  
Insert the assembly to the unit straight along right and left rails, and then push it until you hear the left lock lever click.

(11) Connect the two flexible tubes to the unit. Insert the tubes into the tank holder straight, holding the end of the tube. Push it until you hear the lock lever click.



(12) Close the basin unit door.

**CHECK**

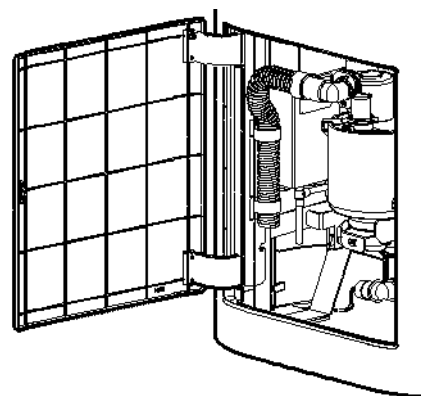
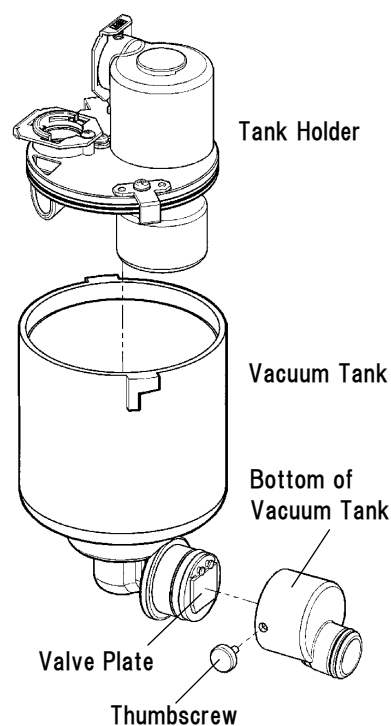
After cleaning, check if the vacuum operates properly.



## 2. Clean the Drain Trap

 CAUTION	
	<p><b>Clean the drain trap at least once a month.</b>                      &gt;&gt;Otherwise, it could cause performance deterioration, breakdown, or clogging of pipes.</p>
	<p><b>After cleaning, make sure the drain trap filter and cap are properly and securely installed.</b>                      &gt;&gt;Otherwise, drain water could leak resulting in damage or a malfunction.</p>

Clean the drain trap at least once a month or whenever the basin does not seem to drain properly.

Follow the procedure below to do this.

- (1) Raise the chair about 100mm and above its lowest position and turn off the main switch.

**ADVICE**

Place a bucket in the lower part of the unit to catch drain water filled in the cap.

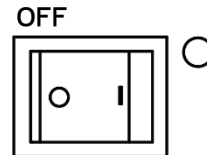

Main Switch  
(Lamp off when OFF)

- (2) Open the door on the unit and unscrew the cap of the trapping part.  
 The drain trap filter is built in the cap.  
 Give it a turn to the left slightly, then a lock is released. Take off the cap straight down so that it is not inclined.

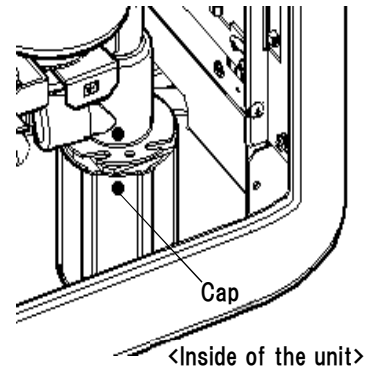

- (3) Replace the drain filter in its original position.  
Put the filter in the cap with its handle facing down and replace both cap and the filter at the same time.

**CHECK**

Do not put the filter in with the handle on the top (upside down) this would make it very difficult to remove.

- (4) Put the sleeve on and then screw the cap back into place.  
Hold the cap straight so that the threads do not get jammed and then screw it all the way to the right.

**CHECK**

Screw the combination mark till the right position.

- (5) After cleaning, pour 2 cups of water into the basin to rinse out the trap.

**ADVICE**

Pouring water down the drain will fill the trap up so the nasty odors do not come up through the drain.

**CHECK**

Make sure there is no leakage from the drain trap.

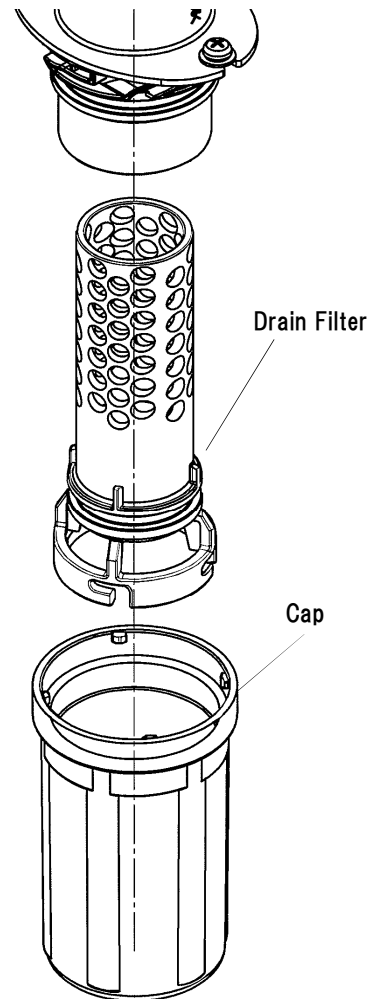



## 3. Inspect and Clean the Oil Drain Filter

At least once a month check the oil drain filter case on the back of the Dentist's tray and see if it is full.

Follow this procedure to clean the filter and case if they are full of oil. Also check to see if the exhaust air for the air turbine is operating properly.

**ADVICE** Place a bucket underneath the case to catch the oil in side it.

- (1) Take off the filter case and empty out the oil.  
Hold the top of the filter case and then turn the case itself to loosen it up.

**ADVICE** Soak up the oil with absorbent paper and dispose of it according to regulations for flammable materials.

- (2) Remove the oil drain filter and the top of the case.  
Pull the filter off and then unscrew its support column.
- (3) Wash all the components with running water and then completely dry and remove all remaining moisture.  
Replace the top of the filter case and the filter support column.
- (4) Check the Exhaust Air for the Air Turbine Operate each of the air turbine handpieces and hold your hand near the support column for the hand- piece to see if air is coming out.

**CHECK** If the exhaust air does not flow properly, stop using the handpiece and contact your local dealer or the Morita Corp.  
More water will tend to mix with the exhaust air if the o-rings on the connection end of the air turbine handpiece are broken. Make sure these o-rings are in good shape.

- (5) If everything is in order, reassemble the filter and its case.

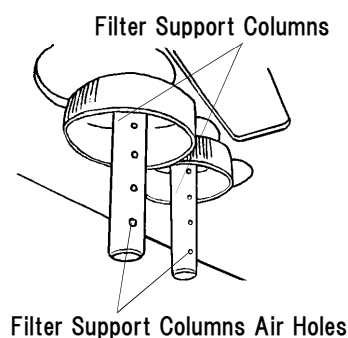
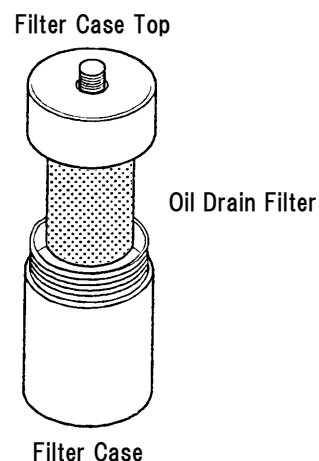

## 4. Clean and Dismantle of Vacuum Syringe / Saliva Ejector

<b>⚠ CAUTION</b>	
<b>⊘</b>	<b>Do not conduct ultrasonic cleaning for disassembled parts of the adjustment lever. Also, do not rub the surface of the parts with a sharp apparatus.</b> >> Surface of the parts can be damaged, and it would disturb to movement.
	<b>After cleaning, make sure the drain trap filter and cap are properly and securely installed.</b> >> Otherwise, drain water could leak resulting in damage or a malfunction.

Once in a month or in case the movement of the suction adjustment part goes sticky or hard, clean disassembled parts of the vacuum syringe.

- (1) Detach the body from the main tube.
- (2) Disassemble the body as a right illustration and take the drum off.
- (3) Clean each part with running water.  
Remove harden substances adhering to each part carefully with a to brush.

**CHECK**

In the case of SE-110, check the state of the O-ring at both ends of the drum. If there are transformation, hardening and deficiency on the O-ring, replace it with a new one.

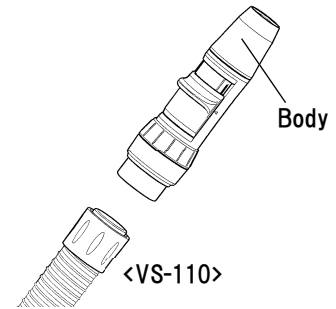

- (4) Reassemble the parts into an original form.  
The lever will move smoothly if you apply a small quantity of Vaseline is to the drum.

**ADVICE**

As for the VS-110, Insert the drum into the body so that the grooves of the drum and the guide inside the body fit.





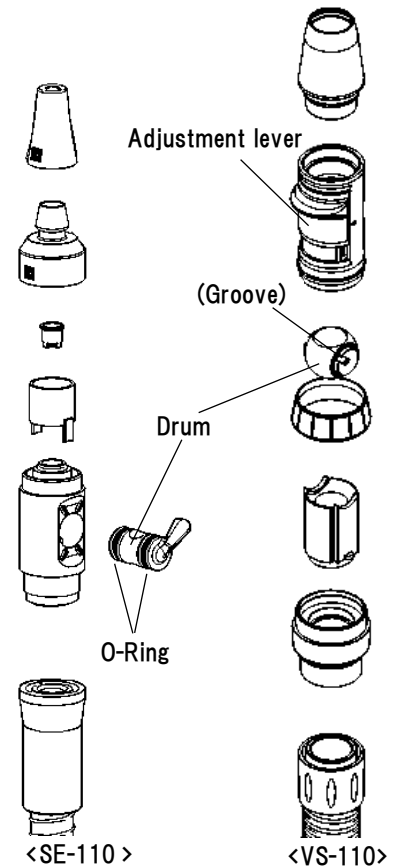

**CHECK**

Then check the drum and the lever are linked together.



Once a Year

## 1. Replacing the Bacteria Cartridges

 <b>WARNING</b>	
	<p><b>Keep fingers clear of the electric panel and electrical components inside the plumbing pit and do not allow these parts to get wet. Also, never move the chair while the plumbing pit is open.</b></p> <p>&gt;&gt; Any of the above actions could result in an electric shock, short-circuiting, pinching or other injurious accidents.</p>
	<p><b>Ensure the pit housing is securely in place. After replacing the bacteria cartridges, unhook the housing and make sure the housing is securely and properly attached.</b></p> <p>&gt;&gt; If the pit housing is not correctly attached, it could fall off resulting in an injurious accident. It could also result in equipment damage or abnormal noise.</p>
 <b>CAUTION</b>	
	<p><b>For the bacteria cartridges, do not conduct the following things.</b></p> <ol style="list-style-type: none"> <li>1. Mixing up the air and water cartridge</li> <li>2. Improper connection of IN and OUT</li> <li>3. Disassembling a cartridge</li> <li>4. Reconnection of a used cartridge</li> <li>5. Using a cartridge to which something is attached or in which something is mixed other than normal tap water and air</li> <li>6. Using cartridges other than those specified by J. MORITA TOKYO MFG. CORP.</li> </ol> <p>&gt;&gt; Otherwise, it will not produce a proper effect and it could cause water leakage, air leakage, or breakdown.</p>
	<p><b>Before taking off the bacteria cartridges, be sure to release the internal pressure in the lines as described below.</b></p> <p>&gt;&gt; Forcing the cartridges off could result in sudden breakage causing an injury.</p>
	<p><b>Before replacing the bacteria cartridges, be sure to close the main water valve and the main air valve.</b></p> <p>&gt;&gt; Otherwise, it could result in water and air leakage.</p>
	<p><b>Be sure to replace the bacteria cartridges once a year. When you see performance degradation within less than a year due to various conditions such as water quality variation, replace the bacteria cartridges immediately.</b></p> <p>&gt;&gt; Otherwise, performance could be degraded, lines could become blocked, and there is a risk of contamination. This could result in water leakage, air leakage or breakdown.</p>
	<p><b>Connect the bacteria cartridges securely.</b></p> <p>&gt;&gt; If connection is improper or not secure, it could cause water leakage, air leakage, breakage or breakdown.</p>

When the bacteria cartridges (for water and air) are equipped, replace them once a year.  
(Product code For water : 4820500 For air : 4820510)  
Follow the procedure below.

- (1) Raise the chair up as high as it will go and turn off the main switch.

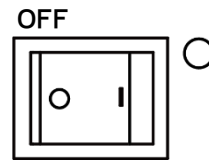

Main Switch  
(Green lamp goes out)

- (2) Close the main water valve and main air valve in the plumbing pit and stop water and air supply.

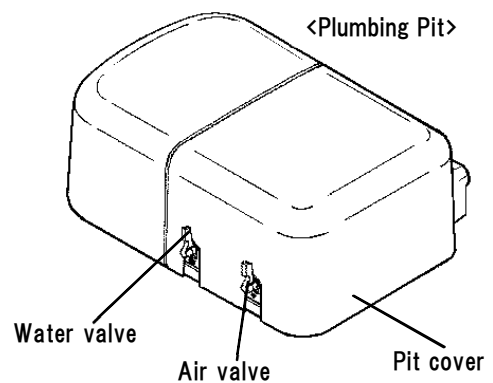

- (3) Use the water and air from the three-way syringe to release the pressure in the air and water lines.

- (4) Take off the pit cover of the plumbing pit. Hold the cover and lift it straight up.

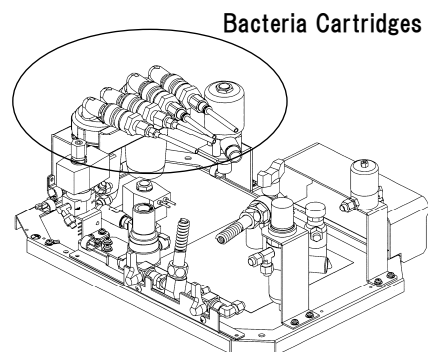

< Plumbing pit (When the pit cover is opened) >

Take off the sockets (two places) and remove the old bacteria cartridge.

Match the ring to a release position (semicircular part), hold the slider part at the end of the socket and take it off straight.

**ADVICE**

When taking off the socket at the water supply side, water filled inside the cartridge might spill out. Prepare a wiping cloth in advance.

(6) Write the replacement date on the label on the new bacteria cartridge.

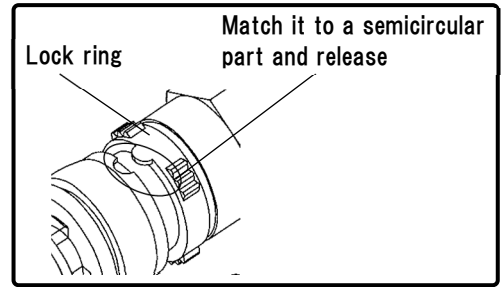

(7) Connect the new bacteria cartridge.

Match a color of connection part of the cartridge and fitted socket (two places), and insert it straight.

<Color of socket>

IN for water : Light blue

OUT for water : Blue

IN for air : Gray

OUT for air : Black

**CHECK**

Confirm so that the connection part of the cartridge and socket become a right combination.

After connecting, confirm that they are securely connected.

Displace a ring of the socket from the release position in order to prevent it from dropping off unexpectedly.

(8) Put the bacteria cartridges into a stand of the plumbing pit and confirm lines whether there is no water or air leakage. Open the water valve and air valve as before. With the main power turned on, flow water and air from the three-way syringe.

**CHECK**

Confirm whether water and air is properly flowed, and whether there is no leakage around the socket.

(9) After confirming, turn off the main switch again and attach the pit cover as before.



(10) Turn on the main switch and confirm that you can use properly.

**ADVICE**

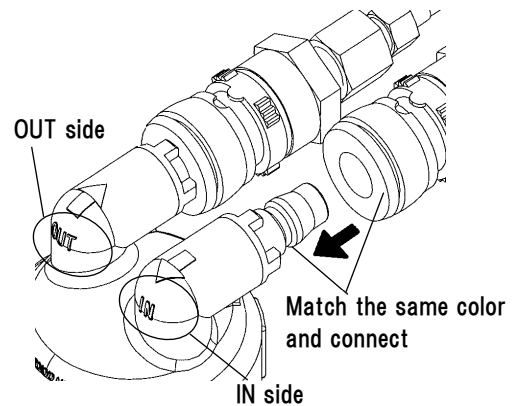
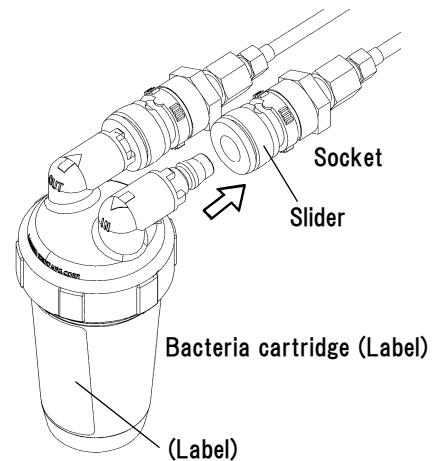
Shortly after replacing the cartridge at the water supply side, air mixes in the water line. Operate the auto filler or others and discharge water until mixed air is discharged.



## [7] Inspection

 <b>WARNING</b>	
	<p><b>For safety and optimum performance, inspect the equipment regularly and conscientiously according to the instructions in this manual.</b></p> <p>&gt;&gt; Otherwise there is a risk of accidents resulting in bodily injury or equipment damage.</p>
	<p><b>If the equipment has not been used for some time, it should be carefully and completely inspected before use to insure its normal and safe operation.</b></p> <p>&gt;&gt; Otherwise there is a risk of accidents resulting in bodily injury or equipment damage.</p>
	<p><b>If the equipment does not operate properly or seems to be out of order, refer to [8] Troubleshooting of this manual and consult your local dealer or the Morita Corp.</b></p> <p>&gt;&gt; Haphazard disassembly, repair or modification could be extremely dangerous.</p>
	<p><b>Regularly inspect and clean the main plug and socket connection (including the ground connection).</b></p> <p>&gt;&gt; A build-up of dust and other debris on and around this connection creates the risk of fire, electrical shock and other accidents.</p>
	<p><b>No modification of this equipment is allowed.</b></p> <p><b>Do not modify this equipment without authorization of manufacturer.</b></p> <p><b>If this equipment is modified, appropriate inspection and testing must be conducted to ensure continued safe use of the effect.</b></p> <p>&gt;&gt; Haphazard disassembly, repair or modification could be extremely dangerous.</p>

For instruments such as the micromotor, scaler, etc. and for devices such as the operating light, visible light cure etc., refer to the separate user manuals for these devices and the list below.

**ADVICE**

The J.Morita Tokyo Mfg. Corp has parts lists and other technical materials for your convenience and will make them available to you if they are needed to make repairs or adjustments. Contact information is on the back of this manual. You may also contact your local dealer.

### 1. Daily Inspection

The inspections listed in the chart should be performed every day before using the equipment. If any problems without simple remedies are found, contact your local dealer or the J. Morita Corp.

## ■ Inspect these items everyday before using the equipment:

No.	Inspection Item	Response or Remedy	Reference
1	Check for loose or wobbly chair, light arm, basin unit, seat, instrument holders etc.	Adjust or tighten.	[4]
2	Check for obstacles beneath the seat and around the chair. (See CAUTION at the beginning of section [5].)	Remove any obstacles and create a clear area around the equipment.	[5] (CAUTION)
3	Check that chair emergency stop works properly. (See section [5] 3. (2) in this manual.)	Check that chair emergency stop and safety switches work properly.	[5]3.(2) ①, ③
4	Check for drain, air, and water leakage (look for wet spots or stains and listen for the sound of escaping air)	Check all connections and repair if necessary.	[4] [6]11.
5	Check the base and plumbing pit housing for scrapes, proper installation, tilting, and abnormal noise.	Inspect visually and by moving the chair.	[6]11.
6	Makesure the foot control, panel switches, air turbine, micromotor ultra sonic scaler and the other instruments all work normally.	Test each instrument by operating it to make sure changeover, display and operation are all normal. Also check the Clean System.	[5]2. ~ 6 .
7	Make sure various functions and equipment such as the auto filler, basin, and interlock work properly.	Check that these work properly, are correctly adjusted, and run for the specified time.	[5]7 . [5]8 .

## ◆ Inspect these items everyday after using the equipment:

No.	Inspection Item	Response or Remedy	Reference
1	Make sure main switch is off.	Turn off the main switch	[5]16.

## 2. Standard Periodic Inspections

In addition to the daily inspections listed on the previous page, perform the following inspection once every 6 months.

If any problems or abnormal conditions are found, contact your local dealer or the Morita Corp. to resolve the problem as soon as possible.

### Main Dental Treatment Unit and Chair

No.	Item	Description	Record	
1	Power Supply Voltage	Use digital or analog tester. Specified standard voltage range: AC 220 / 230 / 240 V $\pm$ 10%		
2	Floor and Base	Check that the floor is level and that the base of the unit has not loosen up or gotten wobbly.		
3	Seat and Backrest manual operation	Use the levers on the foot control to move the seat and backrest. Repeat 3 times.		
4	Auto Positioning	Use the auto positioning switches to set the chair in each auto position. Repeat 3 times.		
5	Emergency Stop for Auto Positioning	Test emergency stop procedures while the chair is in the midst of auto positioning. Repeat 3 times. (Refer to the operation manual for the various emergency stop procedures.)		
6	Headrest	Check the headrest's movement (both angle and slide bar). (Refer to the operator's manual for adjustable parts.)		
7	Electrical circuitry and wiring	Check the printed circuit boards, electrical components and elements for: 1. loose connections, 2. frayed insulation and 3. broken or bent leads.		
8	Air, Water and Hydraulic Lines	Check all water, air and hydraulic lines for: 1. loose connections, 2. wobbly connections 3. broken, bent, or pinched lines, and 4. cracks.		
9	Seat and Backrest Installation	Check for: 1. looseness, 2. wobble and 3. squeaking or grating noise.		
10	Screw and outer cover tightness.	Check all screws, bolts and housing for: 1. looseness, 2. wobble, and 3. missing screws, bolts or other parts, 4. scrapes, tilting, scratches, bending		
11	Internal cleanliness.	Look for dirt, dust or other contamination inside the unit and clean it as necessary.		
12	Quantity of oil	When the chair is in the reset position(Chair height: lowest, Backrest angle: 70° ), quantity of oil shall be 30mm or more from the bottom of the oil tank.		

### Air Turbine Handpieces

13	Handpiece connections.	Check and repeat 3 times: 1. handpiece detachment and attachment. 2. Handpiece does not come off when given a light tug.		
----	------------------------	--	--	--



# SIGNOGIO II

No.	Item	Description	Record		
Air Turbine Handpieces	14	Air Pressure	Operate the handpieces and check the pressure gauge on the back of the tray. (Refer to the handpieces' operation manuals for the correct pressure reading.)		
	15	Water and air connections and lamp.	Check the main tube connection and exhaust air line for: 1) air leakage; 2) water leakage; 3) poor spray; 4) burned out lamp; 5) defective wiring and electrical connections; 6) poor exhaust air		
Micro-motor	16	Micromotor Operation	Check for: 1) Proper attachment connection 2) Proper rotation and variable speed control 3) Proper forward/reverse and speed range changeover 4) Worn clutch or other replaceable components		
	17	Air water electricity and lamp	Check tube connection and various lines for: 1) air leakage; 2) water leakage; 3) poor spray; 4) burned out lamp; 5) defective wiring and electrical connections		
VC/SE	18	Vacuum Syringe and Saliva Ejector	Check: 1) syringe and ejector suction start and stop; 2) tip and SE nozzle attachment; 3) leakage at main tube connection; 4) vacuum tank float switch operation		
WS	19	Threeway Syringe	Check: 1) proper delivery of air, water, and spray; 2) levers do not wobble or twist 3) leakage at main tube connection.		
Basin	20	Auto Filler	Check: 1. Water starts automatically when cup is put in place. 2. Water stops when cup water reaches proper level. 3. Sensor is not dirty, scratched or damaged.		
	21	Snap On Water and Air Connectors	Check: 1) connector can be properly connected and disconnected; 2) there is no leakage at joint; 3) water and air are properly delivered.		

### 3. Replacement Parts List

For optimum performance and safety, use the list below to replace parts which wear out in the course of normal use.

Contact the J. Morita Corp. or your local dealer to order parts.

It may not be possible to supply parts for units more than ten years old.

TU101 Replacement Parts List			
No.	Part Name	Frequency	Replacement Instructions
1	Bacteria Filters (water and air)	Every year.	See [6] 11. of this manual.
2	Cases for bacteria filters		
3	Fuses	Whenever it burns out or seems to be too dim. Whenever one blows or because of poor performance.	See [5] 16. of this manual.
4	Various O-rings Cut Filter Cover and other parts	Whenever these are broken, worn out or stretched or because of poor performance	Contact your local dealer or the Morita Corp.
5	Gaskets for valve plate, diaphragm etc.		
6	Filters Cut filter etc.		
7	Main Tubes Air turbines, vacuum syringe etc.	Whenever these are broken, contaminated or stretched or because of poor performance	
8	Tubing Flexible tubes etc.		
9	Valves WS valve case etc.	Whenever damaged or because of poor performance	
10	Autoclavable parts (see list )	Whenever these are damaged or contaminated or because of poor performance	
11	Disposable items Paper cups and caps etc.	Whenever supply runs out.	
12	Hydraulic Oil	Whenever supply runs too low	
13	Leather covering for seat, backrest, headrest etc.	Whenever these are cracked, worn out or dirty	
14	Retainer for Film Viewer (all types)	Whenever it is damaged or deformed or does not work properly	

## [8] Troubleshooting

Use the chart below to solve operational problems.

Contact the J. Morita Corp. or your local dealer if the problem cannot be solved by following the chart below or for malfunctions and defects not mentioned in the chart.

Problem	Possible Cause	Response	Reference
No power when main switch is turned on. (Switch does not light up.)	① Plug and socket inside plumbing pit are not connected.	① Connect plug and socket.	[5] 15.
	② Blown fuse.	② Replace fuse.	[5] 16.
Seat or backrest does not move.	① Emergency stop activated.	① Remove obstacles etc. to cancel emergency stop.	[5] 3.
	② Temporary malfunction due to electrical noise etc.	② Turn main switch off and then back on again.	[5] 15.
Backrest moves when foot pedal is depressed	Attempt to override the emergency stop	Remove any obstacles etc. and release emergency stop	[5] 3.
Panel switches do not work at all.	Interlock inside basin unit has been activated	Turn lock OFF.	[5] 9.
Panel switches do not work properly (cannot changeover etc.)	① Pressing another switch simultaneously.	Press only one switch at a time	—
	② Another switch is being held down.	Check all switches on the panel.	
Micromotor does not rotate.	Fuse on motor's printed circuit board is blown.	Replace fuse.	[5] 16.
Dentist's instrument does not work.	Handpiece lock is activated	See if handpiece lock is activated. Release if necessary.	[5] 3.
No suction or weak suction for vacuum syringe or saliva ejector	① Cut filter or vacuum tank need cleaning.	① Clean filter or tank.	[6]
	② Cut filter or vacuum tank are not properly connected. (Connection is not tight enough.)	② Connect all components properly.	[6]
Basin does not drain properly.	Drain trap filter needs cleaning.	Clean filter.	[6]
Auto Filler does not supply water	Sensor surface need to clean	Clean filter.	[5] 8.

## [9] Warranty and Repairs

### 1. Product Warranty

If the product malfunctions while being used correctly as described in this manual, it will be repaired and components replaced free of charge during the period and within the range specified on the purchaser's warranty (separate document).

Refer to the back of the warranty for details.

### 2. Warranty Registration

After purchasing the product, fill out the customer's warranty, give a copy to the dealer and keep a copy for yourself.

### 3. Repairs

#### (1) During Warranty Period

Present the warranty and make your repair request to the source of the purchase or your nearest Morita dealer. Repairs will be free of charge. However, the user may have to bear the expense of components not covered by the warranty such as parts which normally need to be replaced periodically.

#### (2) After the Expiration of the Warranty Period

Make your repair request to the original sales outlet or your nearest Morita dealer. If the product can be restored to normal operating condition by repairs and parts replacement, the owner will bear the expenses of the repairs.

### 4. Replacement Parts Availability Period

Replacement parts will be available for at least 10 years after the manufacture of the product is discontinued. However, after this period replacement parts may no longer be available and repairs may not be possible.

## [10] Disposal of Medical Devices and Equipment

### 1. Disposal of this equipment and its components

This equipment including its various components and replacement parts is deemed to be medical equipment.

Any medical devices which could possibly be contaminated must be first decontaminated by the responsible doctor or medical institution and then be disposed by an agent licensed and qualified to handle medical and industrial waste.

Even devices and equipment that is not considered to be a contamination risk must be disposed of according to local laws and regulations.

## [11] Specifications

General Designation	Dental Treatment Unit
Name	SIGNO G10 II
Model	TU101
Intended purpose	This product, installed in a dental clinic, locates a patient to a position for medical examination, delivers air, water, vacuum, and electricity to dental equipment which is intended to be attached and operates it, and supplies and drains water for rinsing out patient's mouth.
Classification	Regulated Medical Equipment (Special Maintenance and Installation)
Rating	220 / 230 / 240V AC
Frequency	50 / 60 Hz
Power Consumption	1.5 kVA
Weight of Main Unit	Approx. 240 Kg (with over-arm and step)
Maximum loading mass	150kg (Seat: 89kg, Backrest: 61kg)
Seat Elevation Mechanism	Hydraulic Pantograph
Seat Height	750mm (max.) 400mm (min.)

Backrest Angle	Raised : $70 \pm 2^\circ$ Lowered : $2 \pm 2^\circ$
Electric shock protection	Class I (permanent installation) Type B with applied device
Water Pressure	0.20 to 0.59 MPa
Air Pressure	0.39 to 0.78 MPa
Three-way Syringe Output	Water and Spray: 30mL / 15sec., minimum
Vacuum Syringe Performance	140 L / min. or more (When EV-12 is connected)
Maximum Electrical Load	Warmer Tank : 190W Three-way Syringe Tube: 20W
Maximum Permissible Load	Foot Control Main Pedal: 1350N
Liquid Invasion	Foot Control IP X 1
Operation Cycles	Chair: 50sec. ON, 5min. OFF
	Penviewer Intra-oral camera: 50sec. ON, 5min. OFF
	Other portions: Continuous Operation
Type B applied parts	Seat, Headrest, Backrest, Armrest, Instruments
Vacuum Cut Filter	0.4mm x 0.4mm mesh

\*About the danger of being related with electromagnetism interference and other interference.

1.This product may cause malfunction under the environment where electromagnetic interference exists.

Installing around communication equipment and the apparatus made to generate electromagnetic waves like an elevator is not permitted.

Moreover,don't use the apparatus made to generate electromagnetic waves like a portable telephone around this product.

2.This product may receive the influence by an electric scalpel.

When you use an electric scalpel, don't turn on the main switch of this product.

\*About the environmental condition at the time of transportation and storage.

1.The method for storage

(1)Temperature:-10-70degrees C

(2)Humidity:10-85RH%

(There is no generating of dew condensation.)

(3)Atmospheric pressure:700-1660hPa

2.Cautions and contraindications matter

(1)Keep it in the place which water does not require.





(2)Keep it in the place where a bad influence with the air having contained a part for ventilation,sunlight,dust,salt,or sulfur does not reach.

(3)Change into the state where the influence of an inclination,vibration, a shock(the time of conveyance is included),etc. does not reach.



(4)Don't keep it at one clue in the place which the storage place of chemicals and gas generate.

3.Durable period

The durable period of this product will be carried out ten years, as long as it is, when. after manufacture shipment and regular maintenance check are performed.

	Conforms with the European Directive,93/42/EEC.
	Conforms with the European Directive,2011/65/EU.
	Manufacturer
	Authorized representative in the European Community

## [12] EMC Technical Description

 <b>WARNING</b>	
	This product requires precautions related to EMC and it is necessary to install and use the product according to the EMC information described in these operation instructions.
	Portable and mobile RF communication equipment may affect this product.
	Portable RF communications equipment should be used no closer than 30cm (12 inches) to any part of the TU101, otherwise, degradation of the performance this equipment could result.
	If accessories other than those sold as replacement parts by the marketing authorization holder are used, performance of this product may deteriorate regarding EMC.
	The use of accessories and cables other than those specified, with the exception of replacement parts sold by J. MORITA TOKYO MFG CORP. may result in increased emissions or decreased immunity of the TU101.
	Where possible this product should not be placed adjacent to other equipment, and should not be use with other equipment. If use with other equipment is required, only proceed after observing that the unit and other equipment work properly together.

### Guidance and manufacturer's declaration-electromagnetic emission

**The TU101 is intended for use in the electromagnetic environment specified below.  
The customer or the user of the TU101 should assure that it is used in such an environment.**

Emission test	Compliance	Electromagnetic environment-guidance
RF emissions CISPR 11	Group-1	The TU101 users RF energy only for its internal function. Therefore, its RF emissions are very low and are not likely to cause any interference in nearby electronic equipment.
RF emissions CISPR 11	Class-B	The TU101 is suitable for use in all establishments, including domestic establishments and those directly connected to the public low-voltage power supply network that supplies buildings used for domestic purposes.
Harmonic emissions IEC 61000-3-2	Class-C	
Voltage fluctuations / flicker emissions IEC 61000-3-3	Complies	

## Guidance and Manufacturer's Declaration-Electromagnetic Immunity

**The TU101 is intended for use in the Electromagnetic environment specified below.  
The customer or the user of the TU101 should assure that it is used in such an environment.**

Immunity test	IEC 60601 test level	Compliance level	Electromagnetic environment-guidance
Electrostatic discharge(ESD) IEC 61000-4-2	$\pm 8$ kV contact  $\pm 2, \pm 4, \pm 8,$ $\pm 15$ kV air	$\pm 8$ kV contact  $\pm 2, \pm 4, \pm 8,$ $\pm 15$ kV air	Floors should be wood, concrete or ceramic tile, if floors are covered with synthetic materials, the relative humidity should be at least 30%.
Electrical fast transient/burst IEC 61000-4-2	$\pm 2$ kV for power supply lines  $\pm 1$ kV for input/output lines	$\pm 2$ kV for power supply lines  $\pm 1$ kV for input/output lines	Mains power quality should be that of a typical commercial or hospital environment.
Surge IEC 61000-4-5	$\pm 1$ kV differential mode  $\pm 2$ kV common mode	$\pm 1$ kV differential mode  $\pm 2$ kV common mode	Mains power quality should be that of a typical commercial or hospital environment.
Voltage dips, basic EMC standard or test method: IEC 61000-4-11	0% UT : 0.5 cycle At $0^\circ, 45^\circ, 90^\circ, 135^\circ, 180^\circ, 225^\circ,$ $270^\circ$ and $315^\circ$		Professional healthcare facility environment
	0% UT : 1 cycle and 70% UT: 25/30 cycles Single phase: at $0^\circ$		Professional healthcare facility environment
Voltage interruptions, basic EMC standard or test method: IEC 61000-4-11	0% UT: 250/300 cycles		Professional healthcare facility environment
Power frequency (50/60Hz) magnetic field IEC 61000-4-8	30A/m	30A/m	Power frequency magnetic field should be at least characteristic of a typical location in a typical commercial or hospital environment. IEC 61000-4-8

NOTE: Ut is the a.c. mains voltage prior to application of the test level



## Guidance and manufacturer's declaration-electromagnetic immunity

**The TU101 is intended for use in the Electromagnetic environment specified below. The customer or the user of the TU101 should assure that it is used in such an environment.**

Immunity test	IEC 60601 test level	Compliance level	Electromagnetic environment-guidance
Conducted RF IEC 61000-4-6	3Vrms (c) 150KHz to 80MHz outside ISM bands	3Vrms 150KHz to 80MHz	Portable and mobile RF communications equipment should be used no closer to any part of the TU101, including cables, than the recommended separation distance calculated from the equation applicable to the frequency of the transmitter. <b>Recommended separation distance</b> $d = 1.17 \times \sqrt{P}$ $d = 1.17 \times \sqrt{P}$ 80MHz to 800MHz $d = 2.33 \times \sqrt{P}$ 800MHz to 2.7GHz where P is the maximum output power rating of the transmitter in watts(W) according to the transmitter manufacturer and d is the recommended separation distance in metre(m). Field strengths from fixed RF transmitters, as determined by an electromagnetic site survey.(a) should be less than the compliance level in each frequency range.(b) Interference may occur in the vicinity of equipment marked with the following symbol 
Radiated RF IEC 61000-4-3	6Vrms (c) 150kHz to 80MHz inside ISM bands	3V/m 80MHz to 2.7GHz	
	3V/m 80MHz to 2.7GHz	3V/m 80MHz to 2.7GHz	

NOTE 1: At 80MHz and 800 MHz, the higher frequency range applies.

NOTE 2: These guidelines may not apply in all situations. Electromagnetic propagation is affected by absorption and reflection from structures, objects and people.

(a) Field strengths from fixed transmitters, such as base stations for radio (cellular /cordless)telephones and mobile radio, amateur radio AM and FM radio broadcast and TV broadcast cannot be predicted theoretically with accuracy. To assess the electromagnetic environment due to fixed RF transmitters, an electromagnetic site survey should be considered. If the measured field strength in the location in which the TU101 is used exceeds the applicable RF compliance level above, the TU101 should be observed to verify normal operation. If abnormal performance is observed, additional measures may be necessary. Such as reorienting or relocating the TU101.

(b) Over the frequency range 150KHz to 80MHz, field strengths should be less than 3V/m.

(c) The ISM(industrial, scientific and medical) bands between 150kHz and 80MHz are 6.765MHz to 6.795MHz; 13.533MHz to 13567MHz; 26.957MHz to 27.283MHz; and 40.66MHz to 40.7MHz.

## Recommended separation distances between Portable and mobile RF communications equipment and the TU101

The TU101 is intended for use in the Electromagnetic environment in which radiated RF disturbances are controlled. The customer or the user of the TU101 can help prevent electromagnetic interference by maintaining a minimum distance between portable and mobile RF communications equipment (transmitters) and the TU101 as recommended below, according to the maximum output power of the communications equipment.

Rated maximum output power of transmitter [W]	Separation distance according to frequency of transmitter [m]		
	150KHz to 80MHz $d = 1.17 \times \sqrt{P}$	80MHz to 800MHz $d = 1.17 \times \sqrt{P}$	800MHz to 2.7GHz $d = 2.33 \times \sqrt{P}$
0.01	0.12	0.12	0.23
0.1	0.37	0.37	0.74
1	1.2	1.2	2.3
10	3.7	3.7	7.4
100	3.7	3.7	7.4

For transmitters rated at a maximum output power not listed above, the recommended separation distance  $d$  in meter(m) can be estimated using the equation applicable to frequency of the transmitter, where  $P$  is the maximum output power rating of the transmitter in watts(W) according to the transmitter manufacturer.

NOTE 1: At 80MHz and 800MHz the separation distance for the higherfrequency range applies.

NOTE 2: These guidelines may not apply in all situations. Electromagnetic propagation is affected by absorption and reflection from structures objects and people.

### System sentence

Additional equipment connected to medical electrical equipment must comply with the respective IEC or ISO standards(e.g. IEC 60950 for data processing equipment). Furthermore all configurations shall comply with the requirements for medical electrical systems (see IEC 60601-1-1 or clause 16 of the 3Ed. of IEC 60601-1, respectively).

Anybody connecting additional equipment to medical electrical equipment configures a medical system and is therefore responsible that the system complies with the requirements for medical electrical systems. Attention is drawn to the fact that local laws take priority over the above mentioned requirements. If in doubt, consult your local representative or the technical service department.

Sources:

-IEC 60601-1:2005:7.9.2.5,8.1,16.2.d

-MDD 93/42/EEC: Annex I clause 13.6.c.

# SIGNOGIO II

Attachment 1.

## Test specifications for ENCLOSURE PORT IMMUNITY to RF wireless communications equipment

Test Frequency (MHz)	Band <sup>a)</sup> (MHz)	Service <sup>a)</sup>	Modulation <sup>b)</sup>	Maximum Power (W)	Distance (M)	IMMUNITY TEST LEVEL (V/m)
385	380 - 390	TETRA 400	Pulse modulation <sup>b)</sup> 18Hz	1.8	0.3	27
450	430 - 470	GMRS 460, FRS 460	FM <sup>c)</sup> ± 5kHz deviation 1 kHz sine	2	0.3	28
710	704 - 787	LTE Band 13, 17	Pulse modulation <sup>b)</sup>  217 Hz	0.2	0.3	9
745						
780						
810	800 - 960	GSM 800/900, TETRA 800, iDEN 820, CDMA 850, LTE Band 5	Pulse modulation <sup>b)</sup>  18 Hz	2	0.3	28
870						
930						
1720	1700 - 1990	GSM 1800; CDMA 1900; GSM 1900; DECT; LTE Band 1, 3, 4,25; UMTS	Pulse modulation <sup>b)</sup>  217 Hz	2	0.3	28
1845						
1970						
2450	2400 - 2570	Bluetooth, WLAN, 802. 11 b/g/n, RFID 2450, LTE Band 7	Pulse modulation <sup>b)</sup>  217 Hz	2	0.3	28
5240	5100 - 5800	WLAN 802.11 a/n	Pulse modulation <sup>b)</sup>  217 Hz	0.2	0.3	9
5500						
5785						

NOTE If necessary to achieve the IMMUNITY TEST LEVEL, the distance between the transmitting antenna and the ME EQUIPMENT or ME SYSTEM may be reduced to 1 m. The 1 m test distance is permitted by IEC 61000-4-3.

<sup>a)</sup> For some services, only the uplink frequencies are included.

<sup>b)</sup> The carrier shall be modulated using a 50 % duty cycle square wave signal.

<sup>c)</sup> As an alternative to FM modulation, 50 % pulse modulation at 18 Hz may be used because while it does not represent actual modulation, it would be worst case.

Basic performance: none

Intended behavior

Cable length

Three-way Syringe  
Output:

Water and Spray: 30mL / 15sec., minimum

Main tube: about 1.5 m

Vacuum Syringe Performance: Volume: 90 L / min., minimum

Foot control: about 700 mm

It depends on the vacuum motor.

(Reference value)

Volume: 140 L / min., minimum

(with EV-12 Type II)



## **J.MORITA TOKYO MFG. CORP.**

7129 Komuro, Ina-machi, Kitaadachi-gun, Saitama Japan 362-0806

Tel: +81-48-723-2621



## **J.MORITA EUROPE GMBH**

Justus-von-Liebig-Str. 27b 63128 Dietzenbach Germany

Tel: +49-6074-836-0