



Dental Treatment Unit

Soaric

INSTRUCTIONS FOR USE
for Taiwan



MORITA

Table of Contents

Warnings, Prohibitions, and Cautions	5
Patient Sitting Posture.....	5
Warnings, Prohibitions, and Cautions.....	6
Safety Switches.....	10
Parts Identification	11
Parts Identification.....	11
Parts Identification; System Display.....	17
Usage	19
(1) Before Use.....	19
Open the Main Water and Air Valves and Turn Power On.....	19
Check System Display.....	20
Flush Out Cleanser.....	21
Select User.....	24
Check before Using.....	25
Check indicator lamps on panel.....	26
(2) Use.....	28
Seat and Backrest Movement.....	28
Headrest Height and Angle.....	33
Position Adjustment for Motorized Headrest (option).....	34
Position Adjustment for Two-axle Headrest (option).....	35
Tray.....	36
Instrument Holder.....	38
Water Supply, Drain, and Air Supply Connectors.....	39
Instruments.....	41
Air Turbine Handpiece.....	42
Micromotor Handpiece.....	47
Threeway Syringe.....	60
Vacuum Syringe.....	63
Saliva Ejector (Option).....	65
Ultra Sonic Scaler (built-in model) (Option).....	66
Ultra Sonic Scaler (built-in model) (Option).....	66
Implant Motor System [Bien-Air: MX-i and MX-i LED Series] (Built-in model) (Option).....	68
LED Light Cure (built-in model) (Option).....	69
Root Canal Measurement Device (built-in model) (Option).....	70
Basin.....	71
Operating Light.....	74
(3) System Display Home Page Icons.....	76
Timer.....	76
Maintenance.....	78
User Registration.....	79

Foot Control Switch Settings.....	80
PC Controls (Option).....	81
Set Calendar.....	84
Monitor Settings (brightness etc.) (Option).....	85
Monitor Settings (brightness etc.) (Option).....	86
Monitor Settings (brightness etc.) (Option).....	87
System Display Settings.....	88
Auto Power Off, Spray Water Temperature Settings.....	88
System Display Overlay in Monitor.....	90
(3) After Use.....	91
Sterilization, Replacement Parts, and Storage.....	92
(1) Sterilization.....	92
Autoclavable Components and Instruments.....	92
Components Disinfected by Wiping with Ethanol.....	95
Regular Maintenance.....	96
Regular Maintenance: Between Patients.....	99
Regular Maintenance: After Use.....	102
Regular Maintenance: Once a Month.....	119
Regular Maintenance: Once Every Six Months.....	122
Rinse Water and Vacuum Lines.....	126
Decontaminate Vacuum Lines and Tank.....	129
(2) Replacement Parts.....	132
Replacement Parts for Air Turbines.....	132
Parts Replacement for Threeway Syringe.....	134
Amalgam Collector Replacement.....	135
(3) Storage.....	136
Maintenance and Inspection.....	137
Regular Inspection.....	137
Maintenance and Inspection Items.....	137
Troubleshooting.....	142
Technical Specifications.....	147
Specifications.....	147
Usability Statement.....	149
Symbols.....	150
Electromagnetic Disturbances (EMD).....	151

Thank you for purchasing the Soaric.

For optimum safety and performance, read this manual thoroughly before using the unit and pay close attention to warnings and notes. Keep this manual in a readily accessible place for quick and easy reference.

Prevent Accidents

Attention Customers

Do not fail to receive clear instructions concerning the various ways to use this equipment as described in this accompanying Operator's Manual.

Fill out and sign the warranty and give the dealer from whom you purchased the equipment his copy.

Attention Dealers

Do not fail to give clear instructions concerning the various ways to use this equipment as described in this accompanying operator's manual.

After instructing the customer in the operation of the equipment, have him fill out and sign the warranty. Then fill in your own section of the warranty and give the customer his copy. Do not fail to send the manufacturer's copy to J. MORITA MFG. CORP.

Prevent Accidents

Most operation and maintenance problems result from insufficient attention being paid to basic safety precautions and not being able to foresee the possibilities of accidents. Problems and accidents are best avoided by foreseeing the possibility of danger and operating the unit in accordance with the manufacturer's recommendations. First thoroughly read all precautions and instructions pertaining to safety and accident prevention; then, operate the equipment with the utmost caution to prevent either damaging the equipment itself or causing bodily injury.

The following symbols and expressions indicate the degree of danger and harm that could result from ignoring the instructions they accompany:



WARNING

This warns the user of the possibility of extremely serious injury or complete destruction of the equipment as well as other property damage including the possibility of fire.

If the symbol () is used, it means mandatory actions that you must take to enforce this procedure.

CAUTION

This warns the user of the possibility of mild injury or damage to the equipment.

* The warning symbols () and caution symbols () that appear next to the main text on the right hand side of the page refer to and are explained by the Warnings and Cautions at the bottom of the page.

(Usage Note)

This alerts the user of important points concerning operation or the risk of equipment damage.

The user (e.g., healthcare facility, clinic, hospital etc.) is responsible for the management, maintenance, and use of medical devices.

This equipment must only be used by dentists and other legally licensed professionals.

Do not use this equipment for anything other than its specified dental purpose.

Disclaimer

- J. MORITA MFG. CORP. will not be responsible for accidents, equipment damage, or bodily injury resulting from:
 1. Repairs made by personnel not authorized by J. MORITA MFG. CORP.
 2. Any changes, modifications, or alterations of its products
 3. The use of products or equipment made by other manufacturers, except for those procured by J. MORITA MFG. CORP.
 4. Maintenance or repairs using parts or components other than those specified by J. MORITA MFG. CORP. and other than in their original condition
 5. Operating the equipment in ways other than the operating procedures described in this manual or resulting from the safety precautions and warnings in this manual not being observed
 6. Workplace conditions and environment or installation conditions which do not conform to those stated in this manual such as improper electrical power supply
 7. Fires, earthquakes, floods, lightning, natural disasters, or acts of God.
- The useful life of the Soaric is 10 years (based on self-certification) from the date of installation provided it is regularly and properly inspected and maintained.
- J. MORITA MFG. CORP. will supply replacement parts and be able to repair the product for a period of 10 years after the manufacture of the product has been discontinued.
- Connect only handpieces and syringes specified by J. MORITA OFFICE to the main tubes; never connect instruments not specified and authorized by J. MORITA OFFICE. Unauthorized instruments could come off during use and cause an injury. J. MORITA OFFICE will not be responsible for malfunctions, damage or injuries resulting from use of unauthorized instruments.

Warnings, Prohibitions, and Cautions

Patient Sitting Posture

- Have patients remove necklaces, glasses and other things that could hinder treatment.
- Have the patient sit as shown in the illustrations below.



For Children

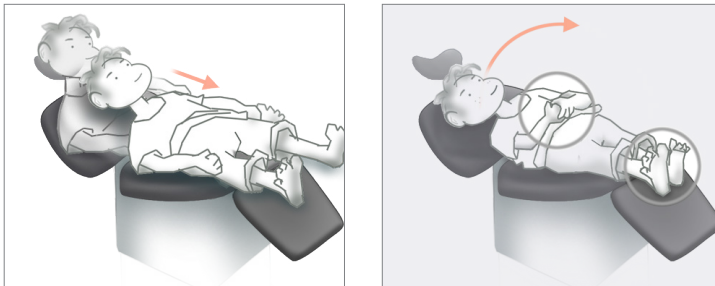

Have the child slide down to the seat before raising the backrest.

WARNING

- The chair is for a single occupant only. Do not let patients hold their children.
- Have the patient seated or lying face up. Do not let patients lie face down or sit on their legs or stand on the chair. Make sure that arms, legs or other body parts are not sticking over the edge of the chair.
- Do not let patients get in and out from the front of the seat or sit on the front edge of the seat.

CAUTION

- Before moving the chair, make sure patient's hands and feet are together and centered.

Warnings, Prohibitions, and Cautions

WARNING

- To avoid the risk of electric shock In case of lightning or the possibility of lightning occurring, stop using the equipment immediately and have the patient move away from it. Open the main circuit breaker and do not touch the equipment or the main power cord.
- Do not use the unit where the floor might be wet.
- Do not use this equipment for patients who weigh more than 135 kilograms.

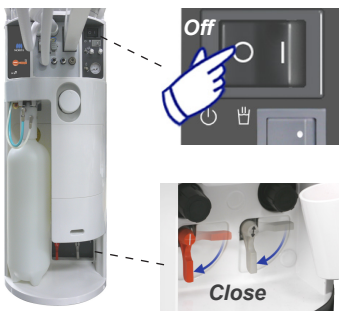

- Avoid electric shocks. Always turn off the main switch and main breaker before replacing fuses.

WARNING

- Turn off the main switch after each use to avoid the risk of overheating, burns, fire, and water leakage.
- Close the main water valve after each use to avoid the risk of water leakage.



WARNING

- Make sure the maintenance cover is closed before moving the chair. Otherwise, there could be an accident.

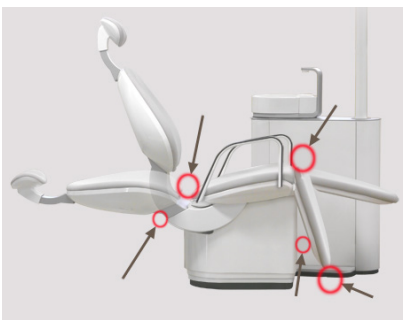

- Before moving the chair, warn the patient and check the following:
 - Make sure nothing is in the way of the chair's movement. Especially check underneath the seat, backrest, and leg rest for the FT type. Make sure no one has his fingers or other body parts in gaps such as those between the seat and backrest or between the seat and leg rest.
 - Patient is not resting his hand on the arm rest.
 - The patient is not firmly gripping the arm rest or any other part of the chair.



- The patient is not holding onto the basin, especially when raising the backrest.

Warnings, Prohibitions, and Cautions

WARNING



- Make sure the patient, seat, or backrest will not hit the tray or assistant instrument holder.

CAUTION



- Warn patients, especially children, not to touch any of the switches. Make sure no one in the treatment area including the dentist, patient, patient's helper etc. accidentally touches a switch with a part of his body or something he is wearing. The chair could suddenly move and result in an accidental injury.
- When you leave the equipment during treatment, press the Chair-lock switch to prevent an equipment malfunction.

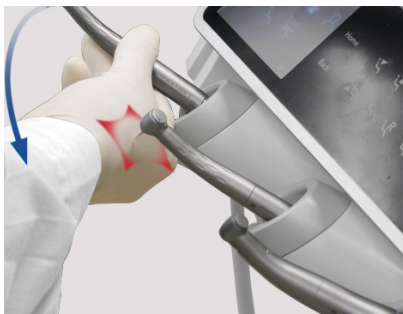

- When picking up a handpiece, be careful not to cut yourself on the burr in another handpiece.



- Watch out when moving the tray. Do not hit the chair or patient with it.
- Do not hit the patient with the Over Arm Tray when moving it.

Warnings, Prohibitions, and Cautions

CAUTION



- Be careful not to accidentally let the elevation ring or any other part of the stool base press a switch on the foot control; this could cause the chair to move or change an instrument setting.

PROHIBITION: This indicates when not to use the equipment.

- Never use ultra sonic scalers, electrical scalpels or electrical root canal measurement instruments for patients who have a pacemaker or an Implantable Cardioverter Defibrillator (ICD); these instruments could cause the pacemaker or the Implantable Cardioverter Defibrillator (ICD) to operate erratically.
 - Electromagnetic waves from cell phones, transceivers, and remote control devices could cause this instrument to operate erratically. Turn off all communication devices of this type in the treatment area.
 - Electrical noise generated by instruments such as electric scalpels could cause this equipment to operate in an erratic and dangerous manner. Turn the unit completely off before using an instrument that produces electrical noise.
- * J. MORITA OFFICE is not responsible for any accidents or injuries that result for not following the prohibitions notes above.

For Safety

■ Check and read all the warning labels on the equipment.

WARNING



Turn off the main switch after each use to avoid the risk of electric shock or fire due to overheating. Ensure the unit is off during electrical storms or when performing any of the following:

- Replacing LED on handpieces
- Replacing vacuum filter
- Replacing drain trap filter
- Replacing anti-bacterial filter
- Disinfecting components and surfaces with ethanol.
- Cleaning vacuum tank
- Taking off basin or cup pedestal
- Removing housing (also turn off circuit breaker)

WARNING



Shut off main water valve after each use to avoid possibility of water leakage.

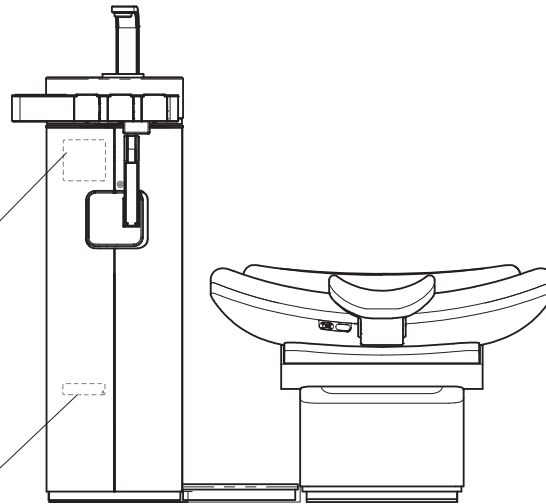

WARNING



Sit with hands and feet together to avoid possibility of trapped limbs.

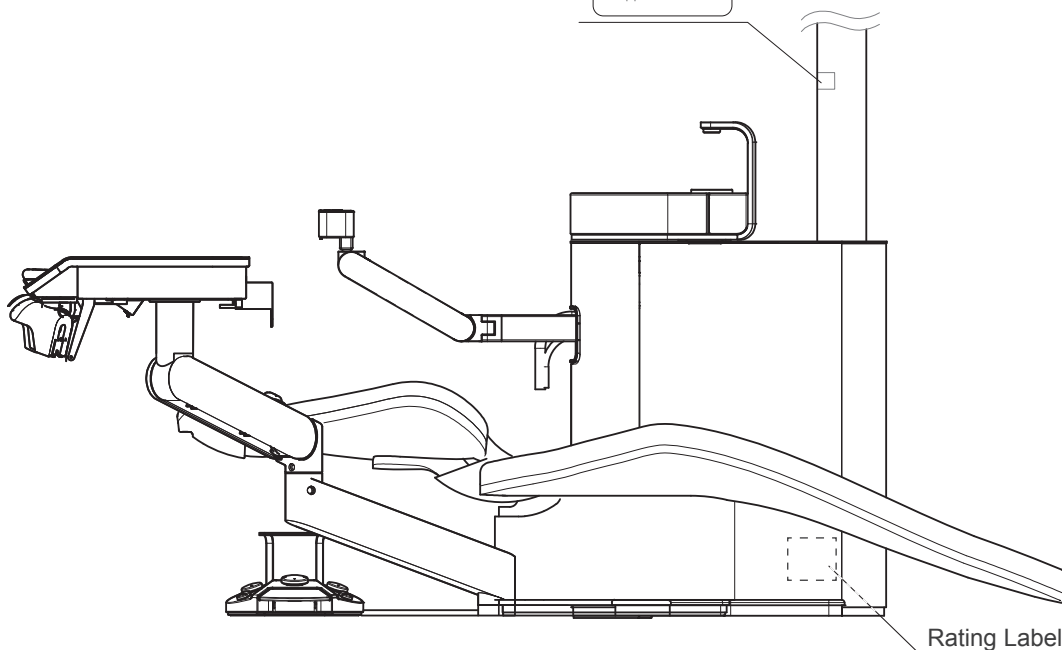

Rating Label

Safety Switches

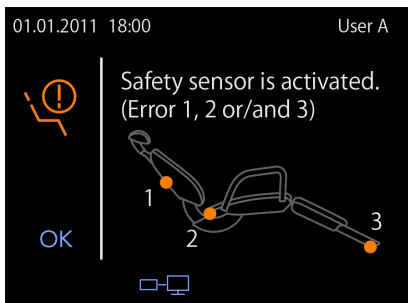

If the safety switch is activated, the equipment will stop, an alarm will sound and the System Display will show the position of the problem. Remove the obstacle that activated the safety switch. Removing the obstacle or pressing OK will turn off the safety switch, and the System Display will go back to its usual screen. If the same safety switch is activated again after pressing OK, check carefully and remove the obstruction that activated it.

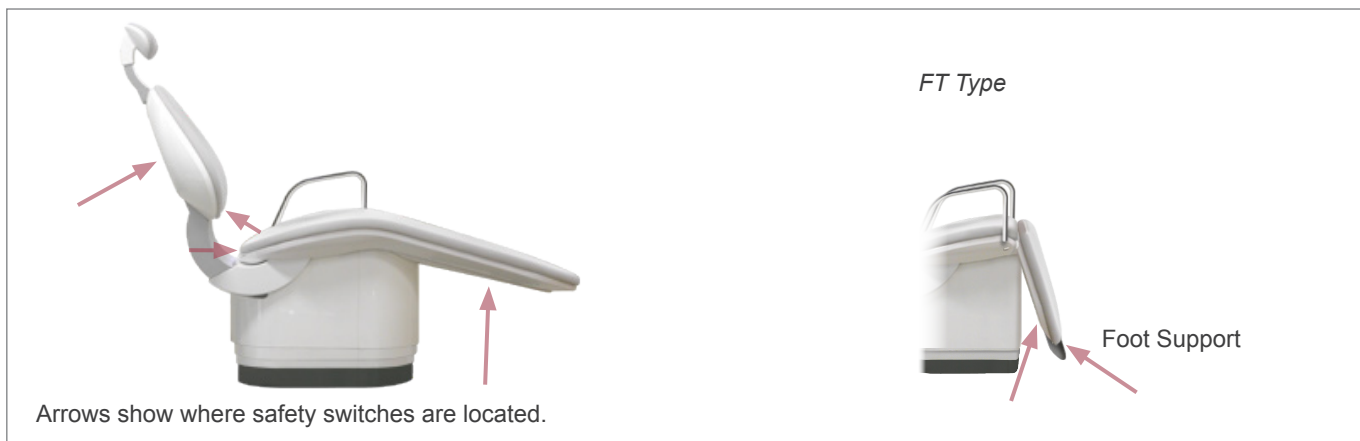

The armrest on the doctor's side is not fixed in place. Fix the armrest in place. (→ page 29)

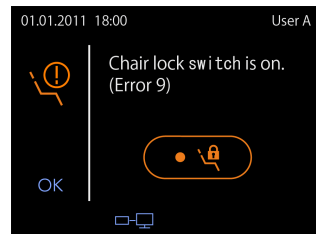
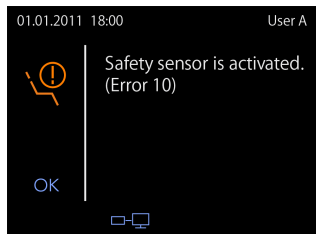
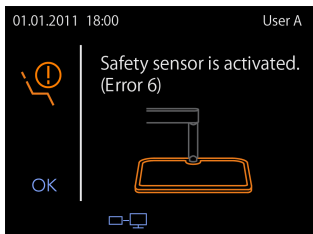

Safety switches other than those for chair movement:

- Assistant's auxiliary tray. Obstacle under the tray.
- Large tray or small tray. Obstacle under the tray
- Basin. Basin is too close to the chair if auto swivel is being used.
- Chair lock switch. Attempted to move chair with chair lock switch turned on.

Parts Identification

Parts Identification

■ Contour Type with Floor-Mounted Tray (FMT-KT)

(*: Option)

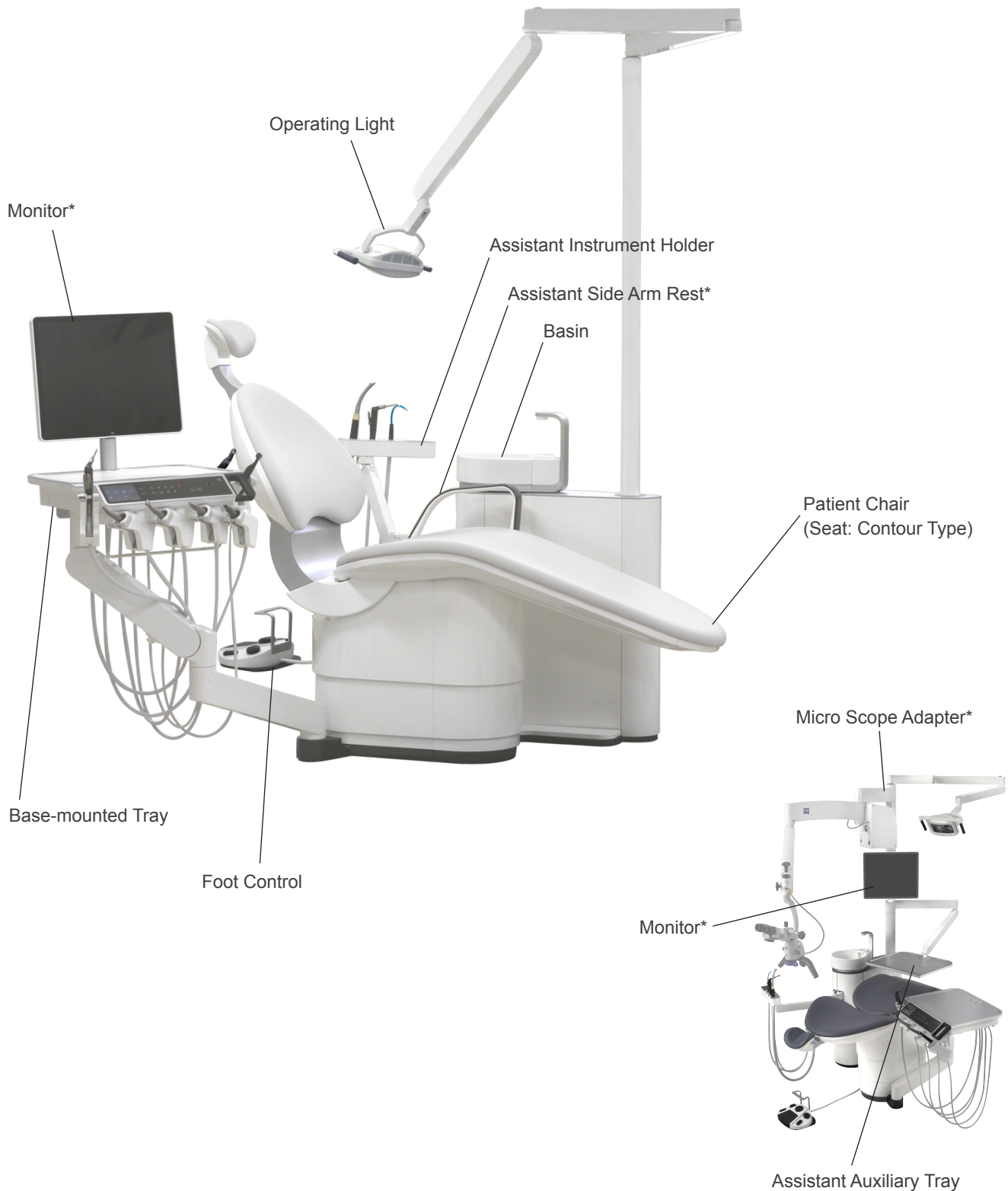

Parts Identification

■ Folding Type with Floor-Mounted Tray (FMT-FT)

(*: Option)

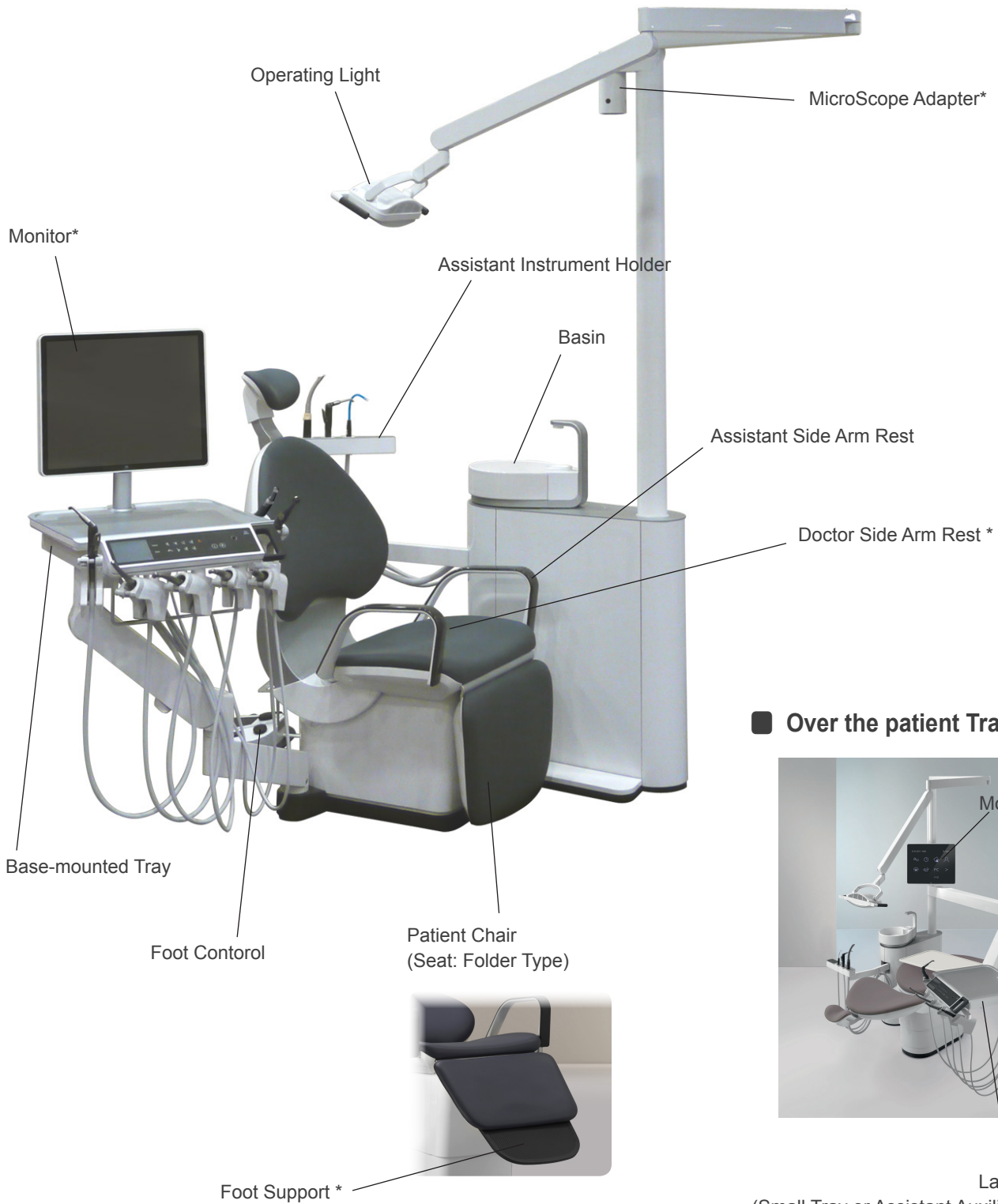

■ Over the patient Tray type



Large Tray
(Small Tray or Assistant Auxiliary Tray also available)

Parts Identification

Floor-mounted Tray

(*: Option)

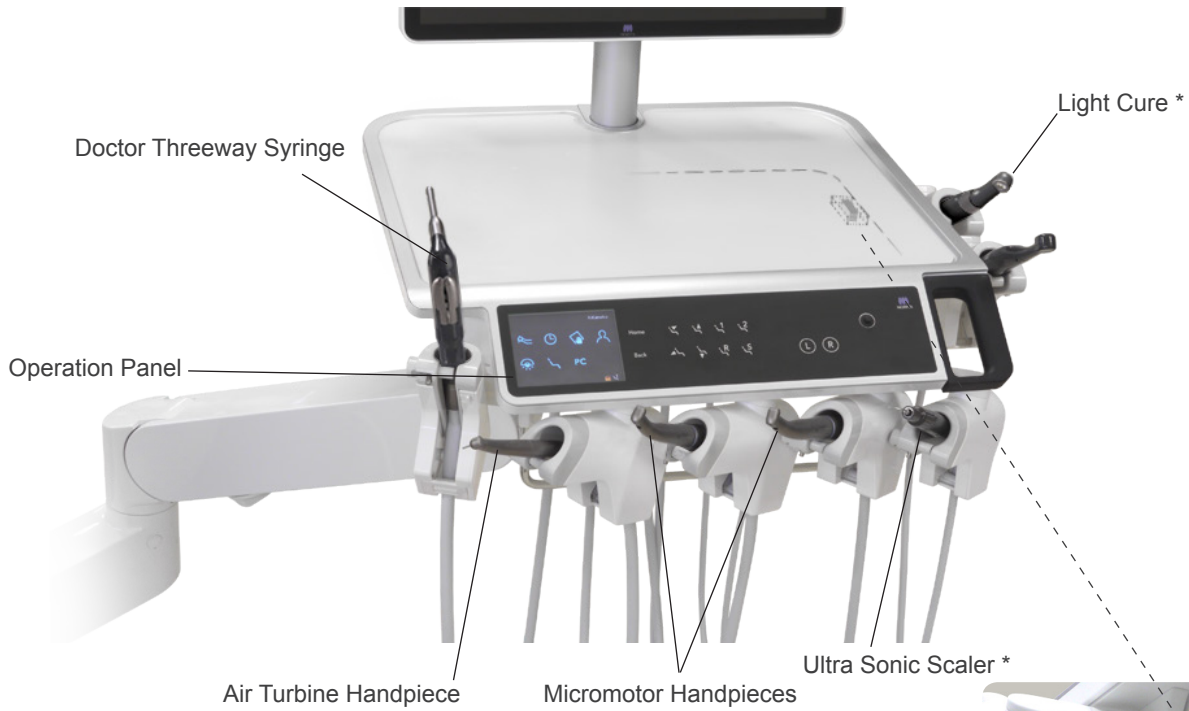

⚠ Do not pull on tubes with too much force.

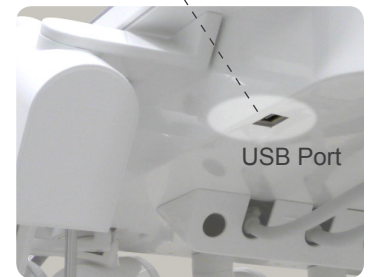

(Back of Tray)

Operation Panel

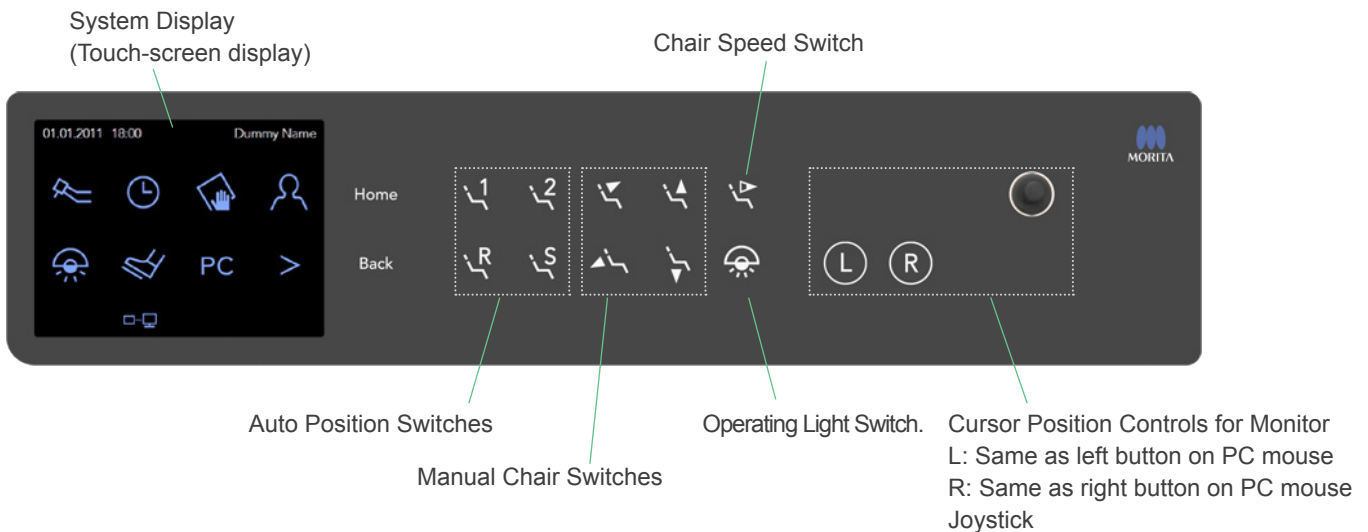

⚠ Use only your finger to press switches.
• Three protective sheets (samples) for the operation panel are provided.

PC Controls (→ page 81)

Parts Identification

Assistant Instrument Holder and Shoulder

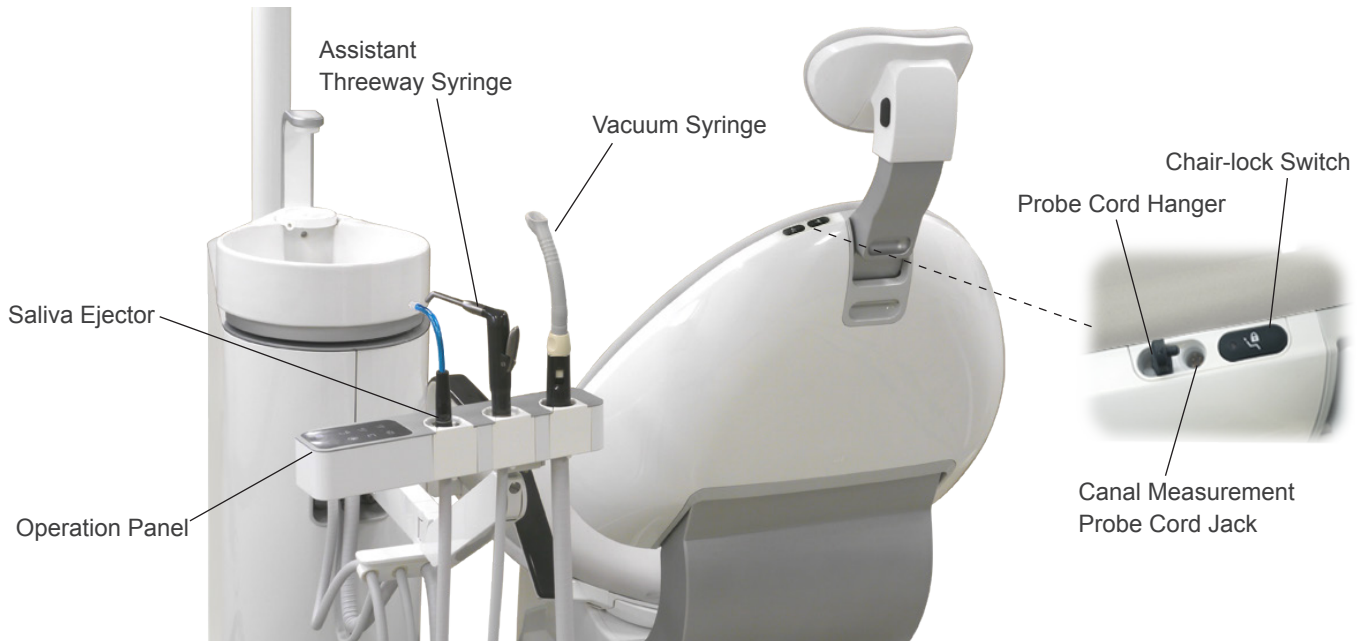

⚠ Do not pull on tubes with too much force.

Operation Panel

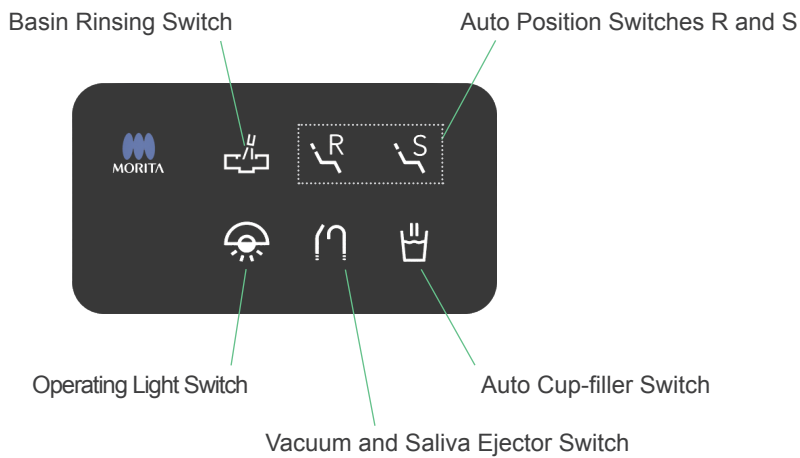

⚠ Use only your finger to press switches.

⚠ If you press an auto switch during tank cleaning, tank cleaning will terminate.

- Three protective sheets (samples) for the operation panel are provided.

Parts Identification

■ Foot control

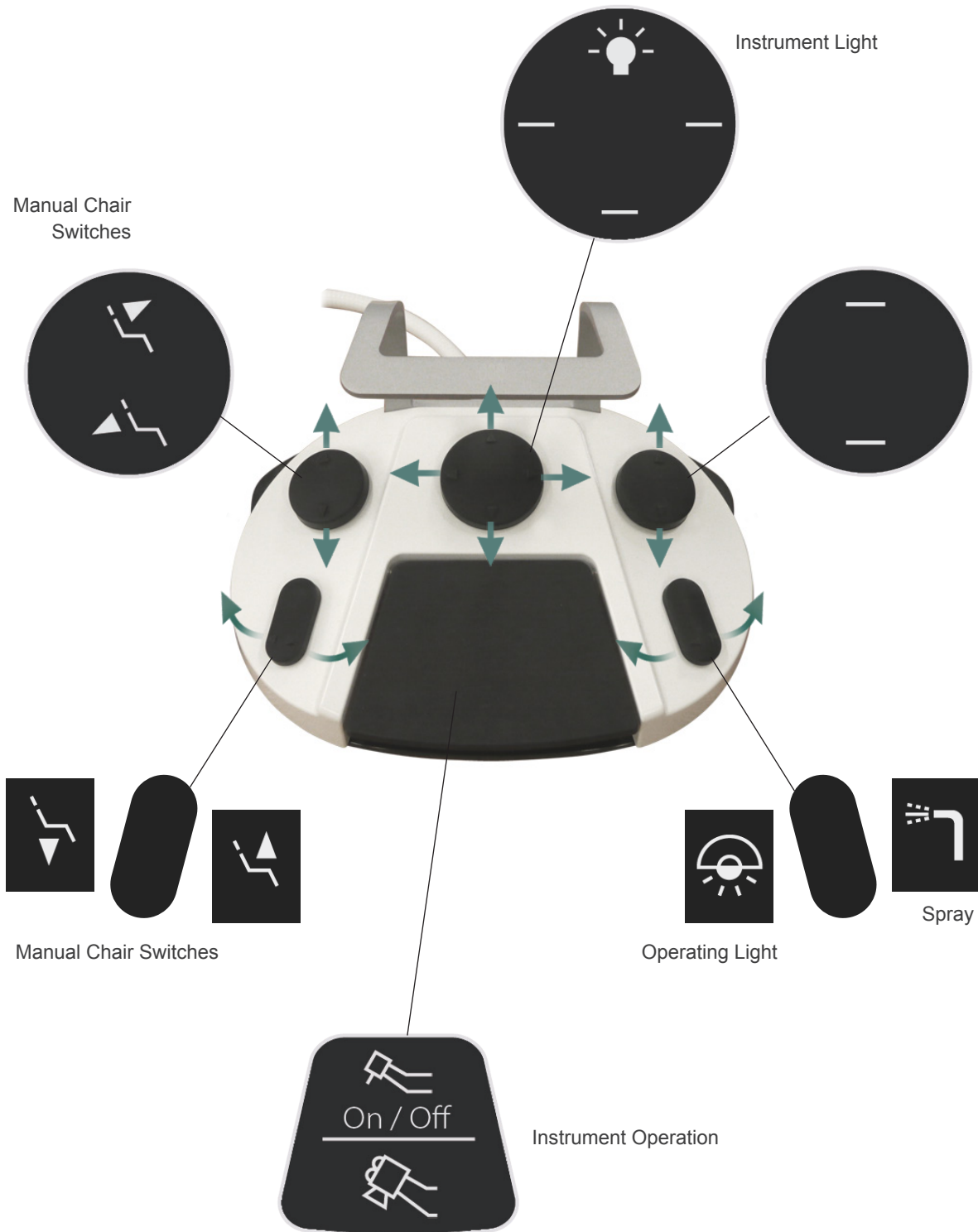

* The factory settings are shown above.

Foot Control Settings (→ page 80)

Parts Identification

■ Maintenance Panel (Inside Maintenance Cover)

Water Decontamination System

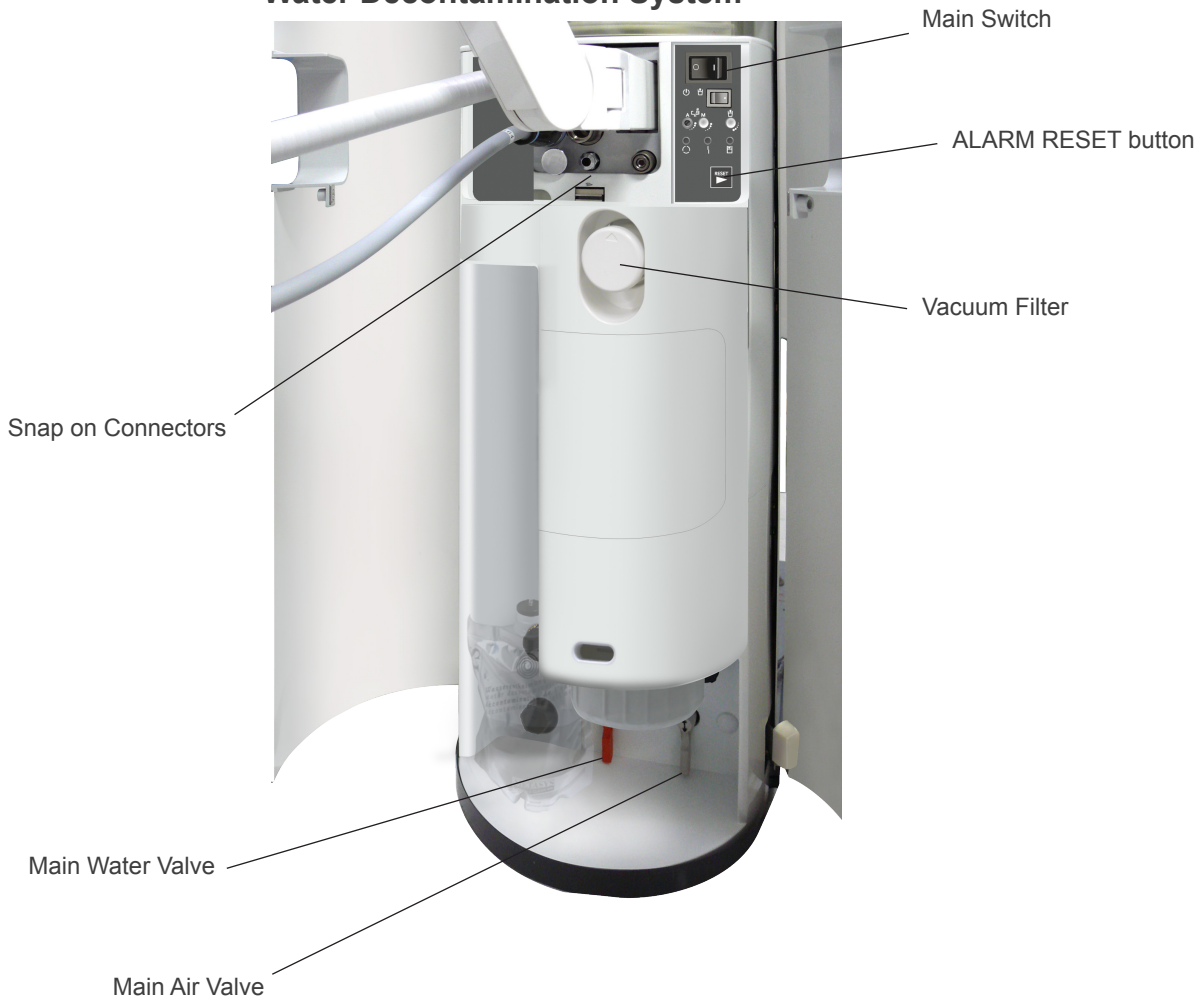

Cleanser Bottle System

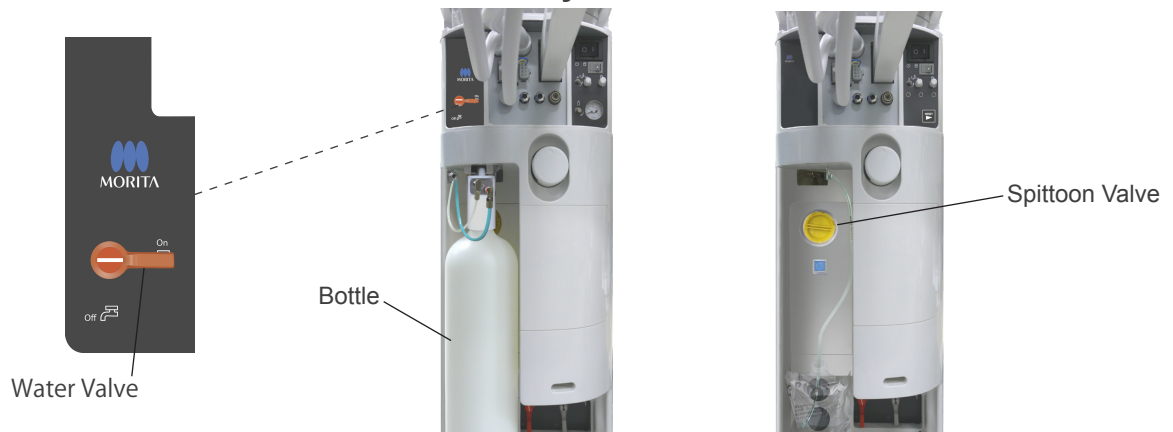

Parts Identification; System Display

■ Home Page 1

* This display is a touch screen panel.

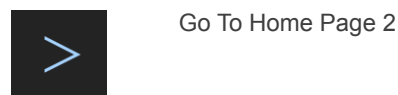
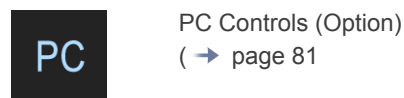
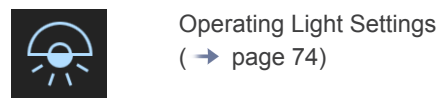
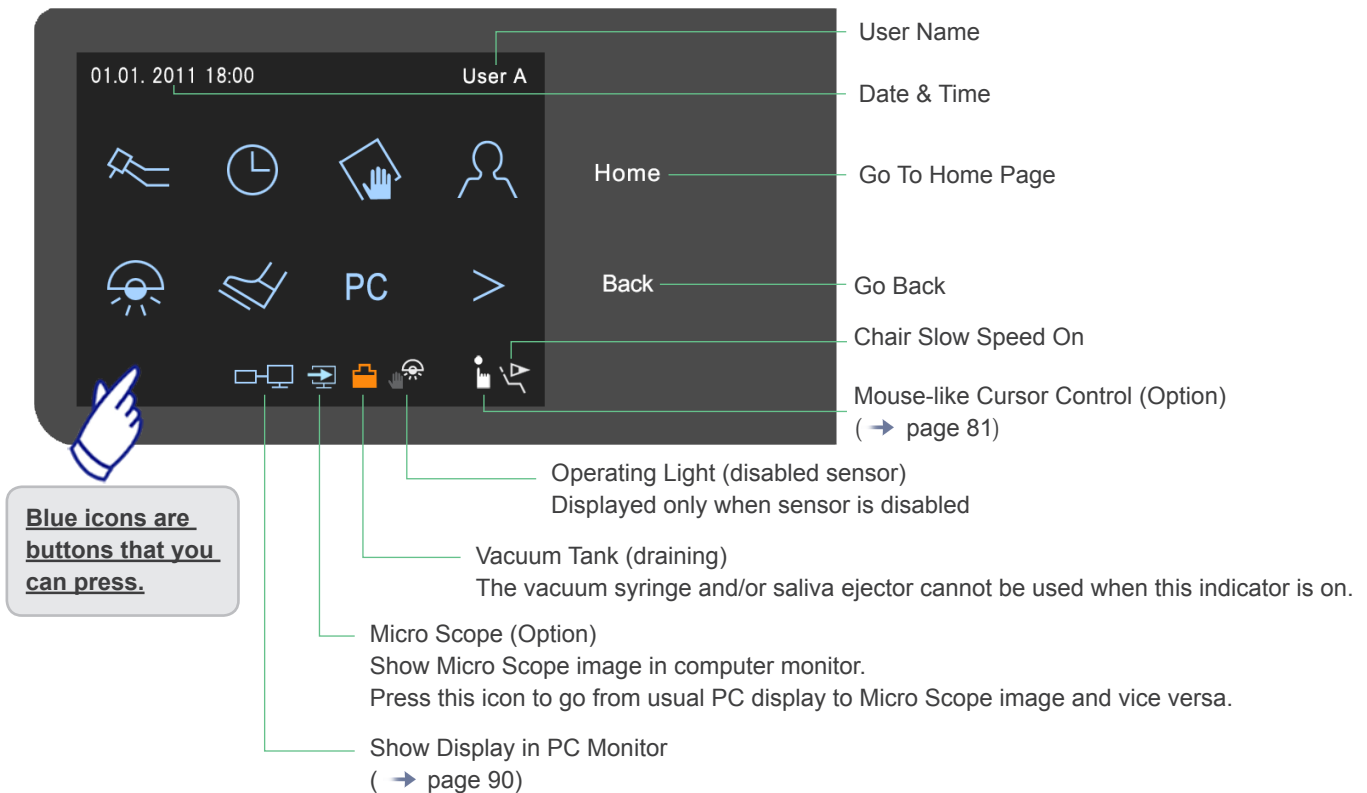

Parts Identification; System Display

■ Home Page 2



Go to Home Page 1



System Display Settings
(→ page 88)



Chair Speed Setting
(→ page 30)



Set Time Lapse for Auto Power Off,
Spray Water Temperature Setting
(→ page 88)



Set Calendar
(→ page 84)



Monitor Settings (brightness etc.) (Option)
(→ page 85)

Usage

* Instruments such as the air turbine handpieces, the micromotor handpiece, and the Luna Vue Light have separate user manuals. Do not fail to read these manuals before using the instruments.

■ Operation Conditions

Temperature: +10°C to +35°C (+50°F to 95°F)

Humidity: 30 % to 75 % (without condensation)

Atmospheric Pressure: 70 kPa to 106 kPa

* If the unit has not been used for some time, make sure it works properly before using it again.

(1) Before Use

Open the Main Water and Air Valves and Turn Power On

1

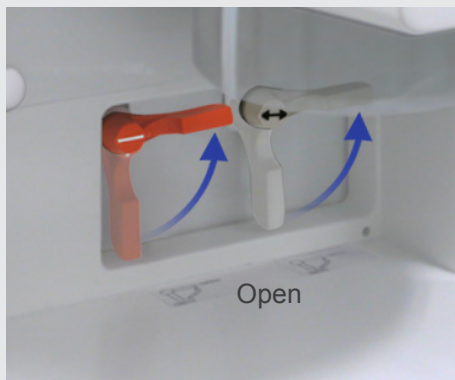

Swing the handles for the main water and air valves up to open them.



2

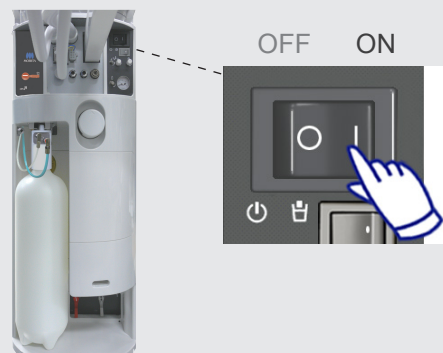

Turn main switch on.

The Home page or some maintenance procedure will appear in the System Display.

* The unit will turn itself off if it is not used for 2 hours (factory setting).



⚠ If the unit has the Optional WEK water decontamination system, an alarm will sound if the main switch is turned on before the water and air valves are opened. In this case, simply turn off the main switch, open the valves and then turn the main switch back on.

⚠ If the power for the Soaric goes off automatically, the i-Dixel computer monitor will also be turned off.

⚠ WARNING

• To avoid the risk of electric shock In case of lightning or the possibility of lightning occurring, stop using the equipment immediately and have the patient move away from it. Open the main circuit breaker and do not touch the equipment or the main power cord.

⚠ CAUTION

• If air leaks or is not properly supplied, the regulator may not be working properly. Contact your local dealer of J. MORITA OFFICE to have the unit inspected.
• Before turning on the main switch, make sure that the switches that move the seat, backrest and other components are NOT turned on; otherwise, the unit might suddenly start to move and cause an injury or accident.

Check System Display

Home Page Appears

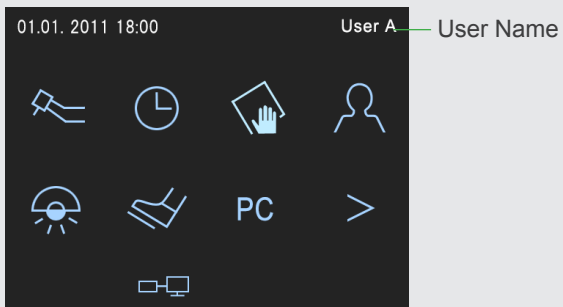

Select the user name and skip to [page 24](#) in this manual.

Maintenance Procedure Page Appears

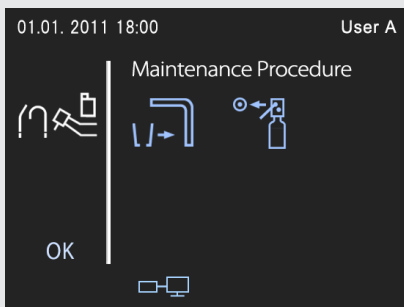

This will appear if you have left cleanser in the water lines using the water bottle cleaning system.

In this case, flush out the cleanser with pure water. See [page 21](#).

Flush Out Cleanser



* Flush out the cleanser in the water lines with clean tap water.

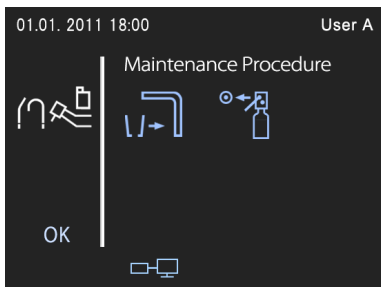

Use the system display to do this.



If the instruments have been returned to their holders, take them out and put them in the flushing device.

1



Set the dummy cup provided on the cup stand and then press OK.

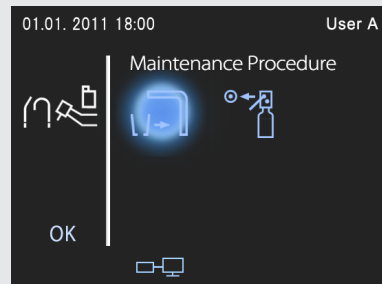

2

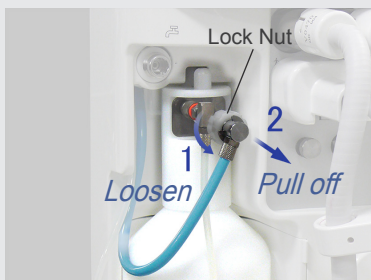

1. Loosen the lock nut.
2. Take the blue water tube off the bottle.



3. Put the blue water tube on the main unit and fasten it with the lock nut.

⚠ Make sure the lock nut is tight enough. Otherwise, water (or cleaner) might not flow properly through the internal lines or water might leak out from the lock nut.

⚠ WARNING

- Do not fail to flush out the cleanser before using the unit for treatment.

⚠ CAUTION

- Make sure the plug is properly and securely connected.

Flush Out Cleanser



⚠ If the blue water tube is hard to put on or take off, coat the O-ring on the lock nut with a little vaseline.

3

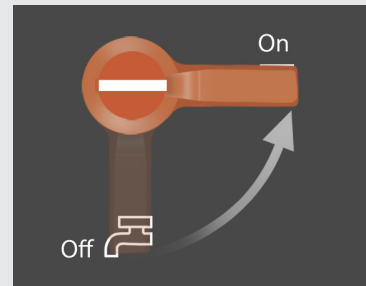

Turn water valve on.

⚠ Do not forget to turn the water valve on after you connect the blue cleanser tube to the main unit.

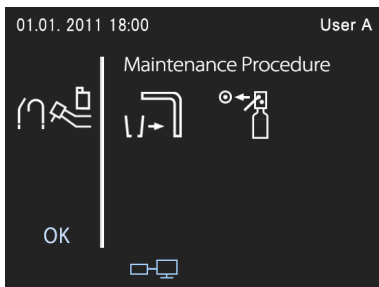

After pressing the button for one of the maintenance procedures, the steps for that procedure will be displayed. After you complete each step, press the icon for that step. It will change from **blue** to **white**. This will help you remember which steps you have completed.

4



Then press OK

5

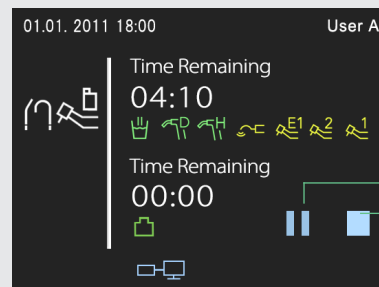
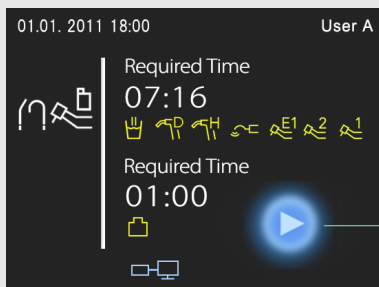

Press the Start button. The time left for completion is displayed.

* If an instrument has been left in its holder, its icon will blink on and off; put the instrument into the flushing device.

* Refer to the next page for stopping the procedure before it is complete.

Before Use

Flush Out Cleanser



6

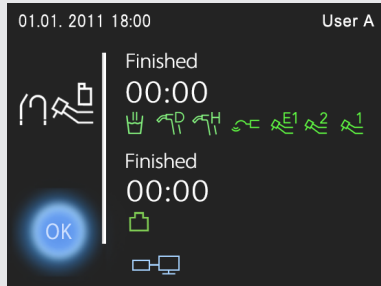

When Finished appears in the display, press OK.

7



Take the dummy cup off the stand and put the instruments back in their holders. Then press OK

ⓘ Before using the threeway syringe or a micromotor attachment, blow air through these instruments to get rid of any water in the lines.

Stopping the Procedure

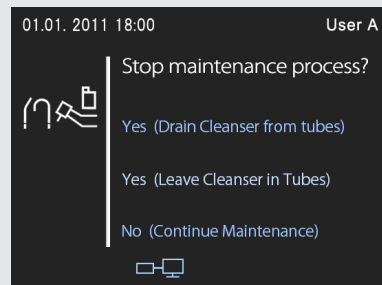
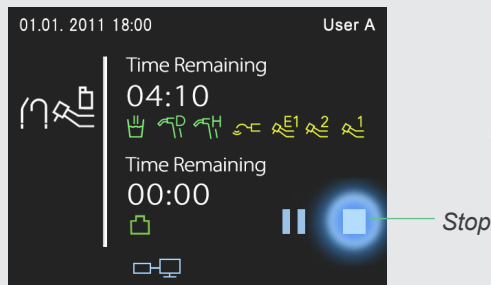

If you press the Stop button, a screen with three choices will appear:

* If you press the button for “Yes (Leave Cleanser in Tubes)”

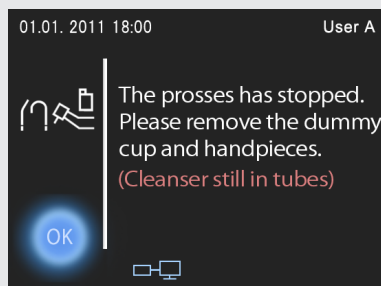

If you press the button for “Yes (Leave Cleanser in Tubes)”, the screen shown here will appear.

Remove the dummy cup and put the instruments back in their holders.

Press OK to return to the Home Page display.

However you must flush the cleanser out of the lines before using the unit for treatment. → See page 126

Select User

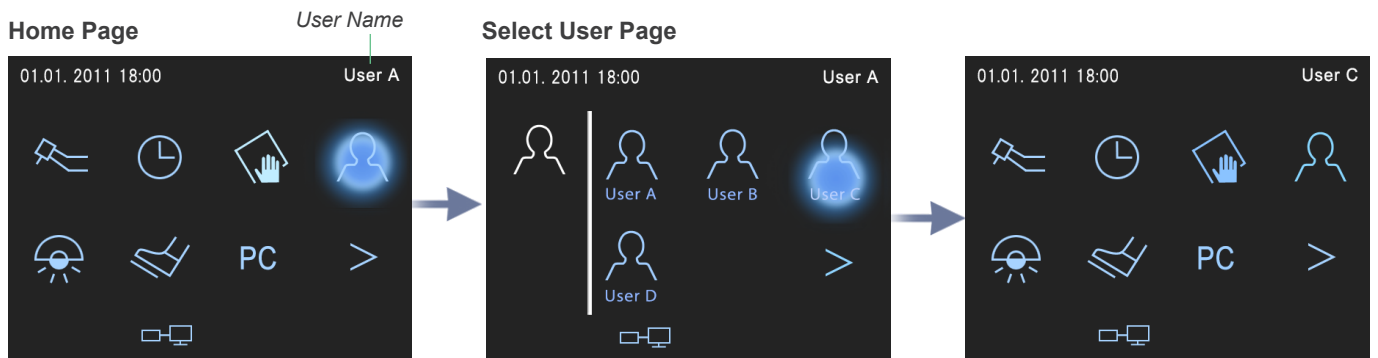

Press the icon in the upper right corner to select or change the user.



ⓘ All settings such as chair positioning etc. will be the ones set for that user.

CAUTION

- Do not fail to check the user name before using the unit for treatment. Otherwise, the various settings for chair positions and instruments may not be the ones you expect.

Check before Using

* To insure safety and normal operation, do not fail to check the following items before using the equipment for actual treatment.

- 1) **Make sure cleanser has been completely flush from the water lines if it had been left in the lines.**
- 2) **Check that all instrument, foot control and chair switches work properly. Connect the instruments and operate them to make sure they run properly.**

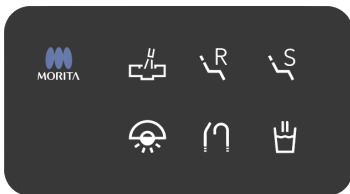

Check indicator lamps on panel

Water Decontamination System

* Refer to the separate user manual for the METASYS Company's WEK.

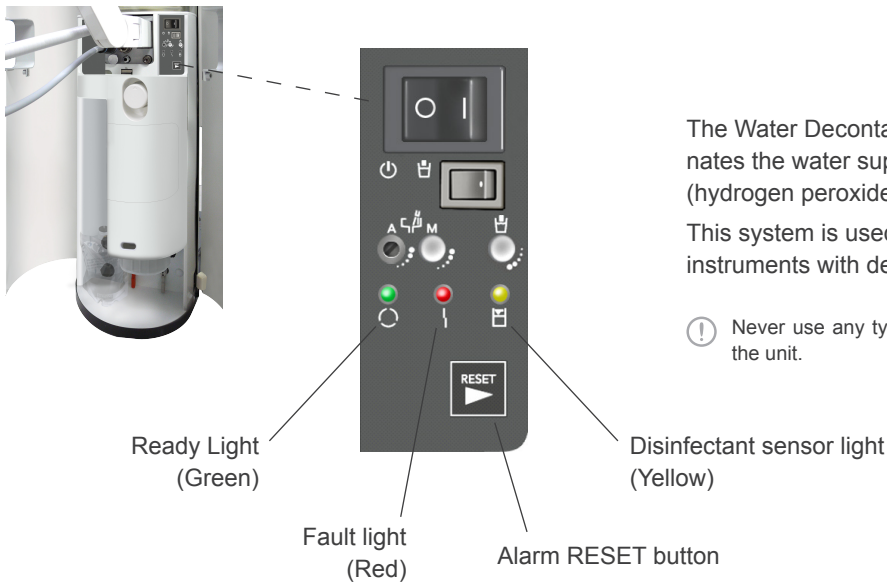

The Water Decontamination System decontaminates the water supply and pipes, using disinfectant (hydrogen peroxide).

This system is used to supply water-fed equipment and instruments with decontaminated water.

⚠ Never use any type of disinfectant except for the type provided with the unit.

Check that green Ready LED for the Water Decontamination System is on.

* If the yellow or red LED lights up, check the following:

* Press the Alarm Reset button to turn the alarm off.

NOTE



If both the green and yellow LEDs light up and the alarm sounds, replace the bag of hydrogen peroxide.



If the green LED is on, the red LED is blinking, and the alarm sounds, press the Alarm Reset button or turn off the main switch to turn the alarm off. Contact your local dealer or repairman. (The detector probe for the mixing container probably needs to be cleaned or replaced.)



If both the green and red LEDs light up and the alarm sounds, press the Alarm Reset button or turn off the main switch to turn the alarm off. Contact your local dealer or repairman. (The pump may be defective or there may be an overflow.)

⚠ WARNING

- Do not get the disinfectant in your eyes or on your hands.
- After decontamination with a more concentrated solution of the disinfectant, reduce the concentration back to the level normally used for treatment.

Check indicator lamps on panel

Amalgam Separator

* Refer to the separate user manual provided by Durr company.

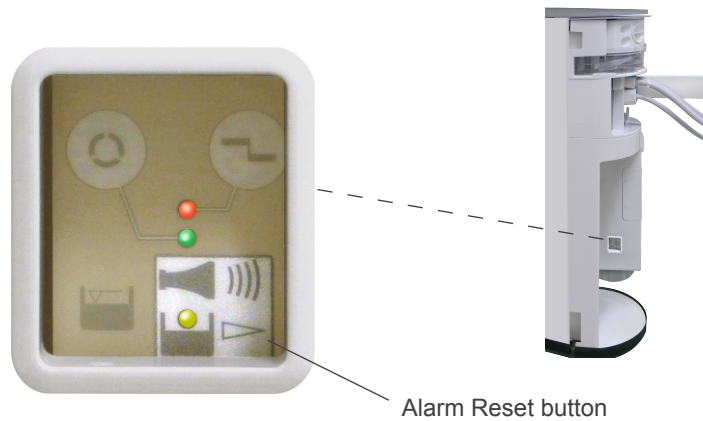





Check that green Ready LED for the Amalgam Separator is on.

* If the orange Fault Light or the yellow Replace Collector Light lights up, refer to the following instructions.

* Press the Alarm Reset button to turn the alarm off.

NOTE

-  Yellow LED lights up, the Green LED lights and there is an audible melody signal:
Amalgam collector is 95 % full.
Change the amalgam collector at a level of 95 %.
-  Yellow LED lights up, Orange LED blinks and there is an audible melody signal:
Amalgam collector is 100 % full.
Replace the collector.
-  Orange LED blinks and there is an audible signal: Collector vessel not in place.
Place the collector in position.
** If this error message appears when the collector is actually in place, then a technical defect is present. Contact your local dealer or repairman.*
-  Orange LED light up, Green LED blinks alternately and there is an audible signal:
Motor defect
Press the Alarm reset button to turn off the audible signal, and hold the key longer than 2 seconds starts the machine again.
** If after pressing the Alarm reset button a number of times, the fault indicator continues to appear then there is a technical defect, Contact your local dealer or repairman.*

(2) Use

Seat and Backrest Movement

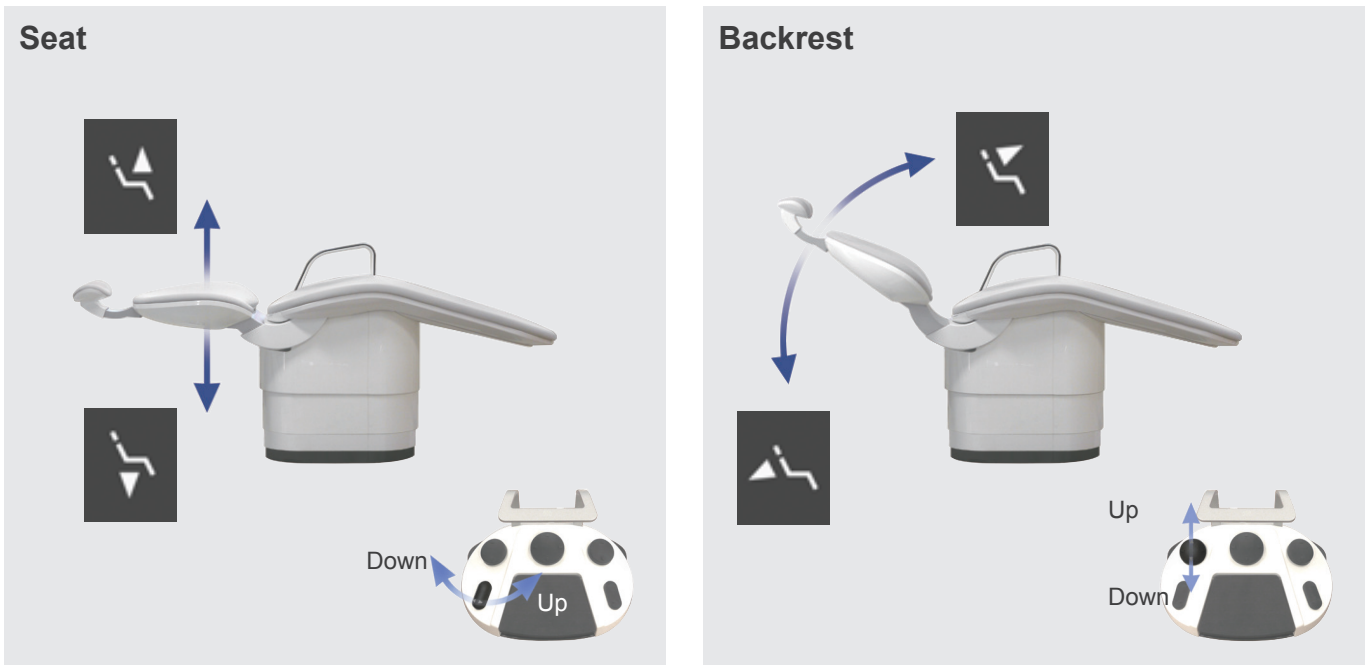

* The chair only moves while you are pressing one of the switches.

* The chair will not move when an air turbine, micromotor or scaler handpiece is in use even if one of the switches is pressed accidentally.



WARNING

- Make sure the basin is in its original position before moving the chair if the chair does not have the optional automatic basin swivel function.

CAUTION

- Take care that the casters on the operating stool do not touch a chair switch on the foot control; this could cause the chair to move and result in an accident.

Seat and Backrest Movement

Arm Rest on Doctor Side (option) and Foot Rest (option) for FT type only



Foot rest comes out as the back rest goes down.

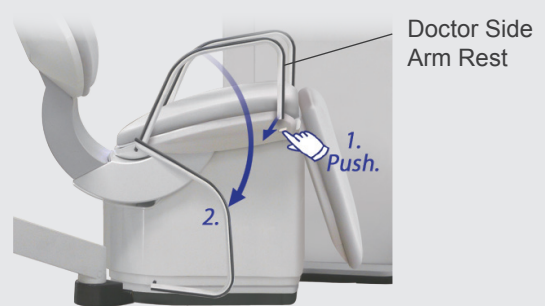

Hold down the switch under the seat and pull the arm out. Then swing it down. Simply put it back to use it again.



Chair-lock Switch



Pressing the Chair-lock switch will prevent the chair from moving during treatment. Even if you mistakenly operate the lever of the foot control, the Auto Position Switches, or the Manual Chair Switches, the chair will not move. Press the switch again to release the lock.



ⓘ You can use the instruments even when the Chair-lock switch is ON.

WARNING

- Use the chair-lock switch to prevent inadvertent chair movement when using a microscope once the microscope has been focused and when measuring or preparing root canals.

CAUTION

- Do not pinch your finger when lowering or raising the arm rest.
- Do not move the chair when the arm rest has been lowered.
- Make sure the arm rest is properly and securely in place.

Seat and Backrest Movement

Chair Slow Speed Switch

Hold down the Chair Slow Speed switch on the operation panel to slow down the chair's movement. Simply hold it down again to return to normal speed.

It is also possible to operate with the foot control switch by changing its settings. (→ see page 80)

- * This is useful to focus a microscope; it is also good for elderly patients.
- * Chair speed depends somewhat on the weight of the patient and ambient conditions such as temperature.

Set Chair Speed

Normal Speed

Slow Speed

slow Fast

To set the speed for the chair's movement, both normal and slow, press the chair speed icon on Home Page 2 of the System Display.

* Slowest speed for normal movement is the same as the fastest speed for slow movement.

CAUTION

- Check the setting for chair speed before using a microscope.

Seat and Backrest Movement

Auto Positioning

Auto Position Switch 1 (R and S)



Auto Position Switch (1, 2, R and S)



<Example: Move chair to position 1>

* To set positions, see section titled "Memorize Auto Positions"

Press Auto Position Switch 1 on the operation panel.

The seat and backrest will automatically move to that position.

Auto Position Switch S: Raise only the backrest for mouth rinsing.
After mouth rinsing, press it again to return the chair to the treatment position.

Auto Position Switch R: Move the chair into position for the patient to get in or out of it.
After the chair has moved, the vacuum tank will be automatically cleaned.

* The settings for switches S (mouth rinsing position) and R (entrance and egress position) are set at the factory.

* The chair can be stopped immediately in case of an emergency in the following ways. Press any switch or the pedal on the foot control. Press any manual or auto positioning switch on the operation panel. (Do not hold a switch down. Otherwise, the switch will activate whatever function it has.)

* The chair will not move when an air turbine, micromotor, or scaler handpiece is in operation.

WARNING

- When using one of the auto switches, make sure the patient is in the proper position as instructed and do not leave the chair.

Seat and Backrest Movement

■ Memorize Auto Positions

There are Three possible positions: 1, 2, and S.

<Example: Set Position 1>

1

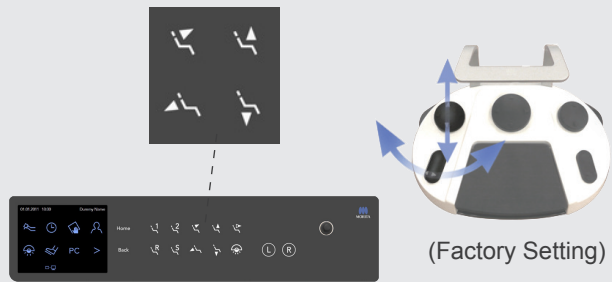

Put the seat and backrest in the desired position.

2

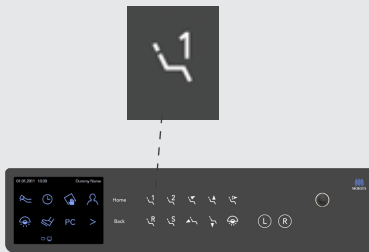

Hold down the Auto Position Switch 1 on the operation panel for about 5 seconds until a beep sounds.

- ⓘ The position will not be memorized if the switch is released before the beep sounds.
- ⓘ If you use the switch on the foot control, the auto position will not be memorized.
- ⓘ Do not change the R position settings.

* If the S position is set so high that the auto swing basin (option) would hit the arm, the basin will not move. In this case, move it manually.

Headrest Height and Angle

Height

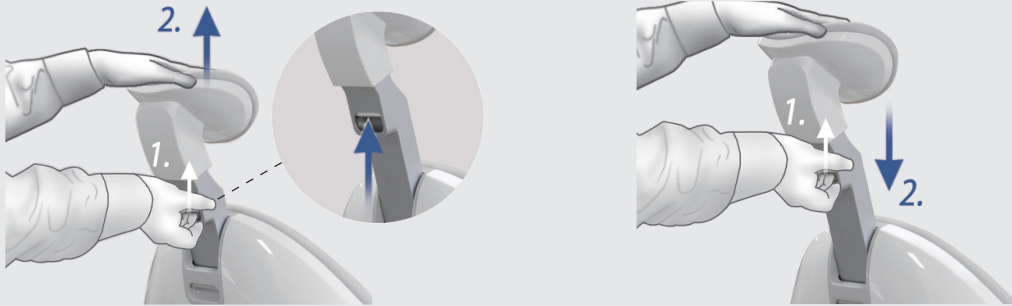

Have the patient lift his head up.
Hold up the catch on the back of the headrest, raise or lower the headrest and then release the catch.



Angle

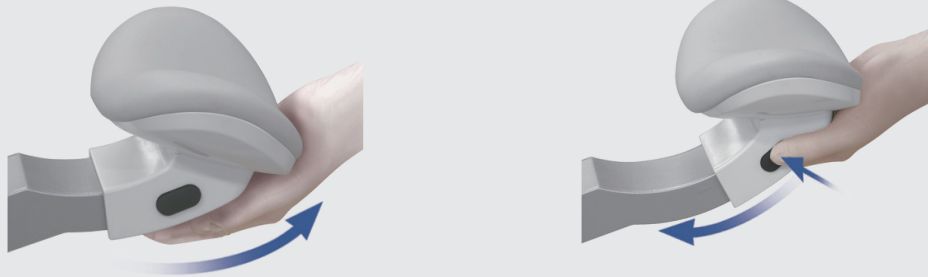

Simply lift the headrest up to raise the angle. (Photo on left.) Hold the headrest with your left hand, hold down the button on the side and lower the headrest. (Photo on right.)
Release the button when it is at the right height.



Backrest Height (option)

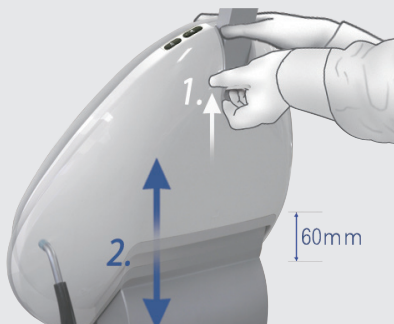

Hold up the catch on the back of the backrest to lower it. To raise the backrest, simply lift it up.

WARNING

- Always support the head rest firmly when adjusting its height or angle. Make sure the headrest is firmly secured after adjusting its height or angle.

Position Adjustment for Motorized Headrest (option)

Height

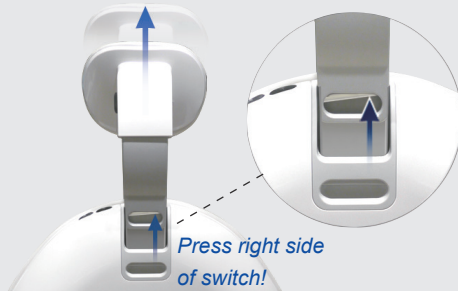

Before adjustment, have the patient lift his head. Push up the right side of the switch to raise the headrest.

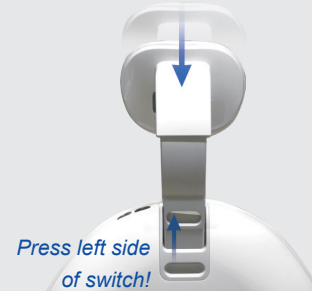

Push up the left side of the switch to lower the headrest. Release the switch to stop the headrest.



Angle

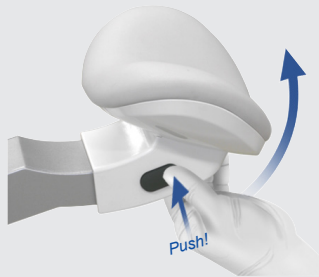

Press the right side of the switch to move headrest up as shown in the photo above.

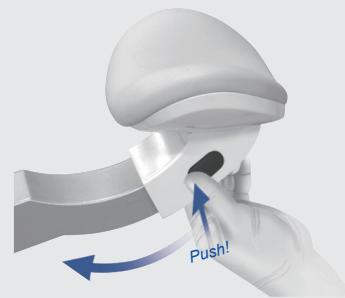

Press the left side of the switch to move headrest down as shown in the photo above. Release the switch to stop the headrest.



Even if you keep holding the switch down, the headrest will temporarily stop at preset positions. These positions are set at the factory.

WARNING

- Always support the head rest firmly when adjusting its height or angle. Make sure the headrest is firmly secured after adjusting its height or angle.

Position Adjustment for Two-axle Headrest (option)

Height

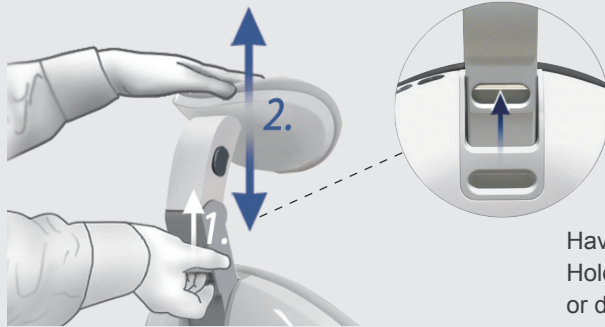

Have the patient lift his head up.
Hold down the slide button and move the headrest up or down to the desired position.
Release the button, to lock the headrest in position.



Angle

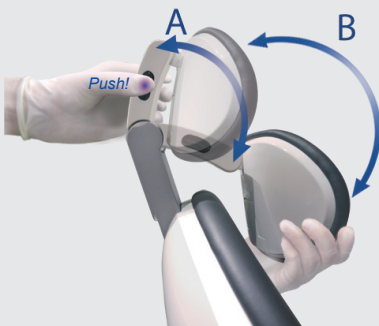

Support the headrest, press down on the center of the release lever, and adjust the angle A and B. Let go of the free lever to lock the headrest in place.



WARNING

- Do not fail to support the headrest while adjusting the angle. The patient could be injured if it suddenly fell down.

CAUTION

- Be careful not to pinch your finger when lowering the headrest.
- Be careful not to pinch your finger when adjusting the angle of the headrest.

Tray

■ Floor-mounted Tray

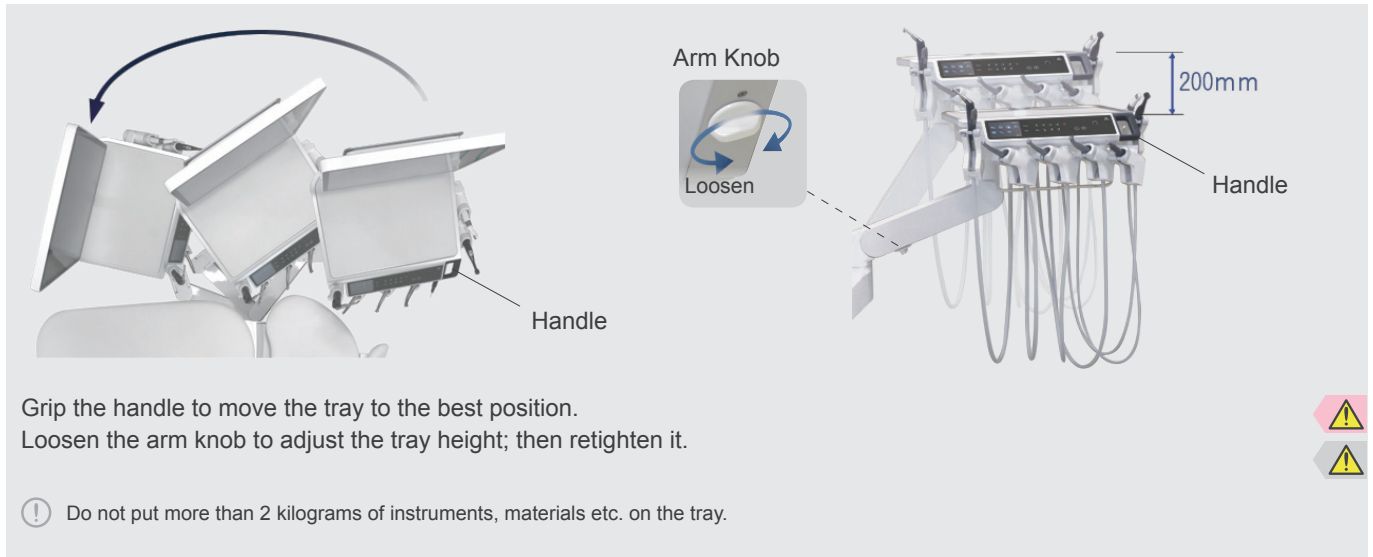

■ Over the Patient Tray

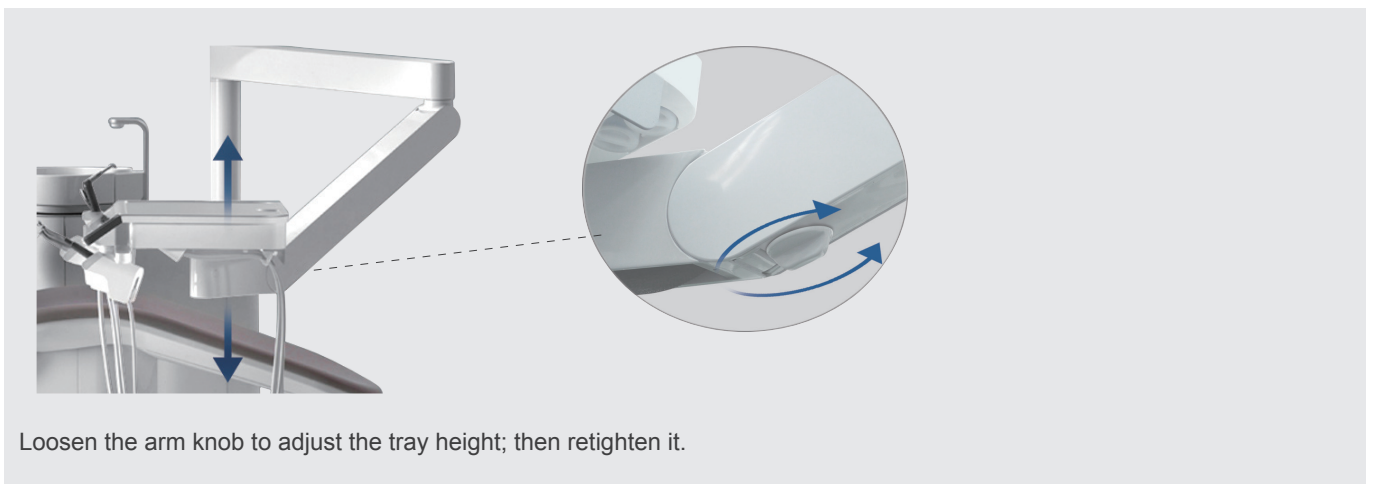

⚠ WARNING

- If you leave a burr in a handpiece, take care that you do not injure the patient or yourself when you remove the handpiece or when you move the tray.

⚠ CAUTION

- Do not place more than 2 kilograms of instruments, materials etc. on the floor-mount tray or more than 1 kilogram on the over-the-patient. The top of the tray could tilt resulting in the spillage of medicines or other accidents.
- If the arm knob is not properly tightened up, the tray could suddenly drop down, resulting in spilled medicine, fallen instruments or other accidents.

Tray

■ Tray Sheet



Spread the silicone sheet on the tray and place the waste cup holder and the medicinal vial holders on the sheet.

- ⚠ If any chemicals (e.g., Creodon, phenol camphor, phenol thymol, formalin cresol, arcrinol, xylocaine, cresol liquid soap, saphoride, iodine glyceriteetc.) are spilled on the tray sheet, wipe them off immediately with ethanol for disinfection (ethanol 70 to 80 vol%). (Otherwise if left for a long time, these chemicals can damage and discolor surfaces.)
- ⚠ Do not put mouse pads etc. on the tray sheet. They may cause discoloration.

Instrument Holder



When an instrument is pulled out, its display will appear in the operation panel.
Put instruments back in their holders after use.

* Whichever instrument was pulled out first always has priority. To use another instrument, put the all other instruments back in their holders.

You can move the assistant's instrument holder in the directions shown by the arrows in the photo to where it is easiest to use.



ⓘ Handle light-equipped handpieces and syringes very carefully. Banging or bumping them could break the LED or disconnect the lamp socket.

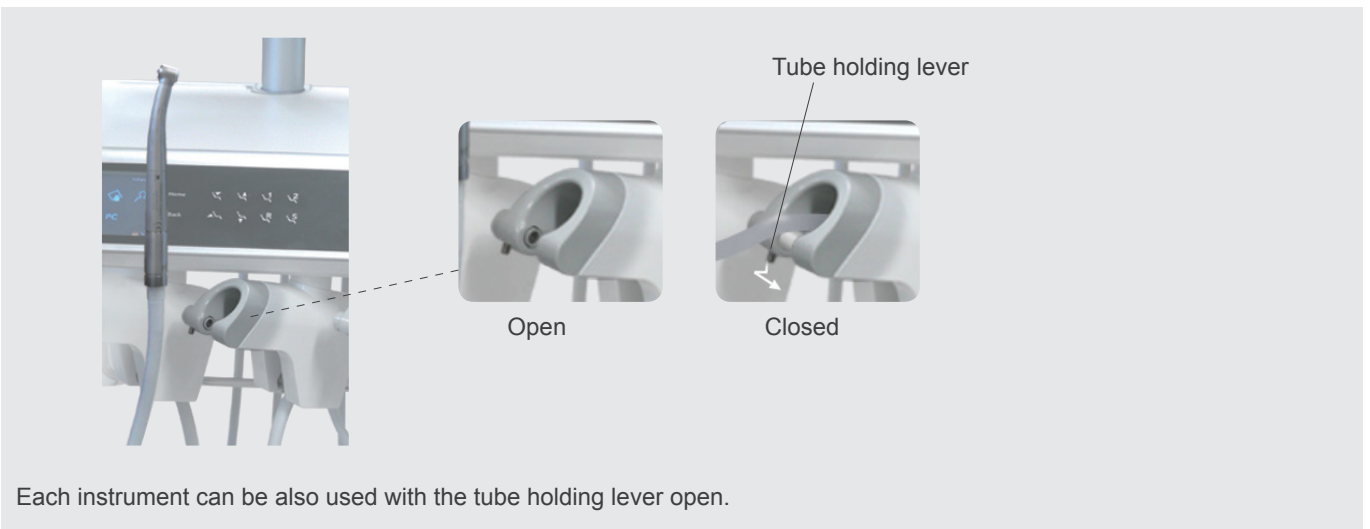

Each instrument can be also used with the tube holding lever open.

WARNING

- Check that the handpiece you are using is displayed in the operation panel. Also check its settings.
- Do not leave burrs, files or tips in handpieces when putting them away. They could injure fingers, hands etc., tear clothes or damage something.

CAUTION

- Make sure that handpieces are put all the way back in their holders. Otherwise, they could fall out or the sensor may not detect that they are present in their holders, and accordingly, the handpieces may start working unexpectedly.
- Do not accidentally hit the chair or the patient when moving the tray.

Water Supply, Drain, and Air Supply Connectors

Connect the water supply tube, drain tube, and air supply tube.

Water Supply Connector



water supply regulating knob

Water Supply Connector

Put on

Insert the water supply tube into the water supply connector until the lever locks into place in the Connector. Turning the water supply regulating knob in the direction of the arrow will increase the amount of water supplied.

⚠ Close the water supply regulating knob after use to avoid the risk of leakage.

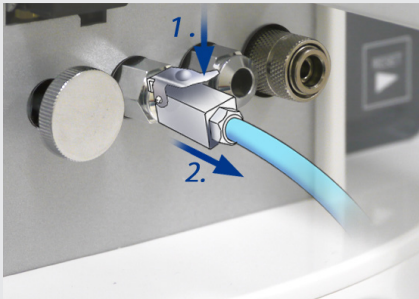

Remove

Pull out the water supply tube while holding the lever down.

Drain Connector

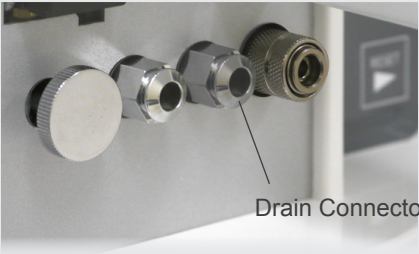

Drain Connector

The drain tube is put on and removed in the same way as the water supply tube.

⚠ When connecting the water supply tube and the drain tube for an agar tray (impression tray), connect the drain tube first.

Water Supply, Drain, and Air Supply Connectors

■ Air Supply Connector



Put on

Insert the air supply tube into the air supply connector.

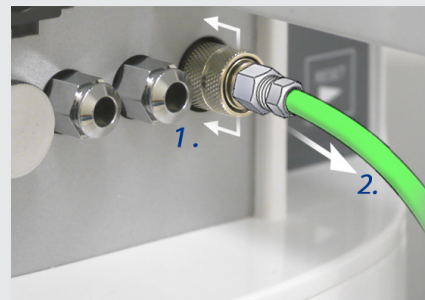

Remove

Slide the outer ring of the air supply connector backward and pull out the air supply tube.

Instruments

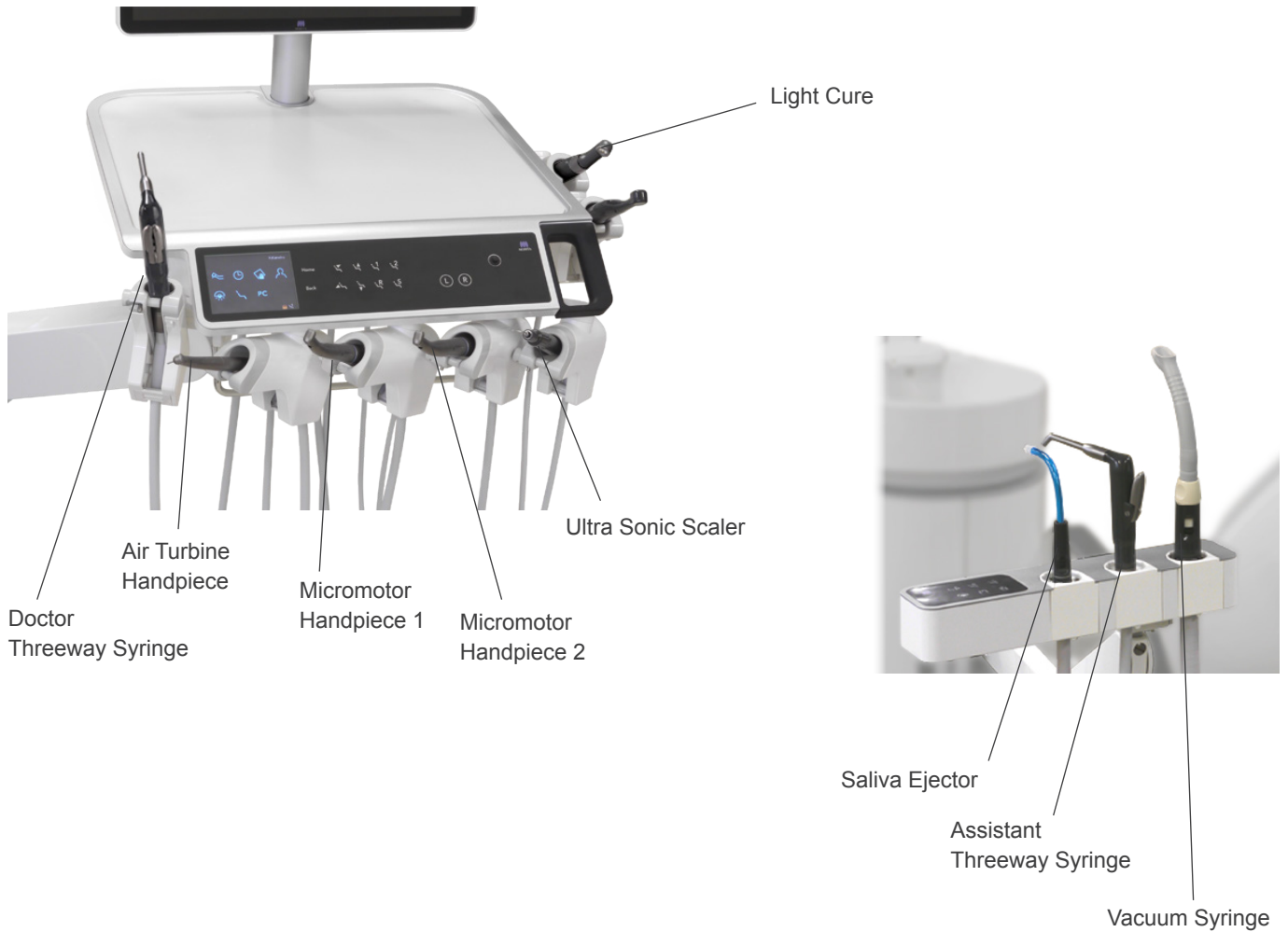

Instrument :

<i>Air Turbine Handpiece</i>	42
<i>Micromotor Handpiece</i>	47
<i>Threeway Syringe</i>	60
<i>Vacuum Syringe</i>	63
<i>Saliva Ejector</i>	65
<i>Ultra Sonic Scaler</i>	66
<i>Implant Motor System</i>	68
<i>Light Cure</i>	69

WARNING

- Connect only handpieces and syringes specified by J. MORITA OFFICE to the main tubes; never connect instruments not specified and authorized by J. MORITA OFFICE. Unauthorized instruments could come off during use and cause an injury.

Air Turbine Handpiece

* Refer to the separate user manual for the hanpiece.

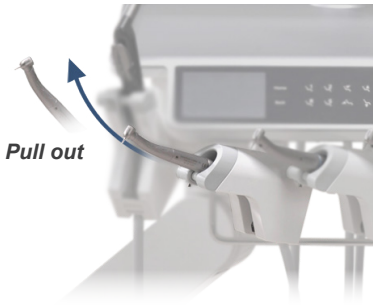

Blue icons are buttons that you can press.

01.01. 2011 18:00 User A

Air Turbine 1 has been selected. This icon changes to yellow when the handpiece is running.

Press this icon to set the brightness for the handpiece light and the timing for spray delivery.

Turn Handpiece Light On and Off

Turn Tube Catch On and Off

Turn Spray On and Off

Select Variable or Constant Speed

Air Turbine Handpiece

■ Use

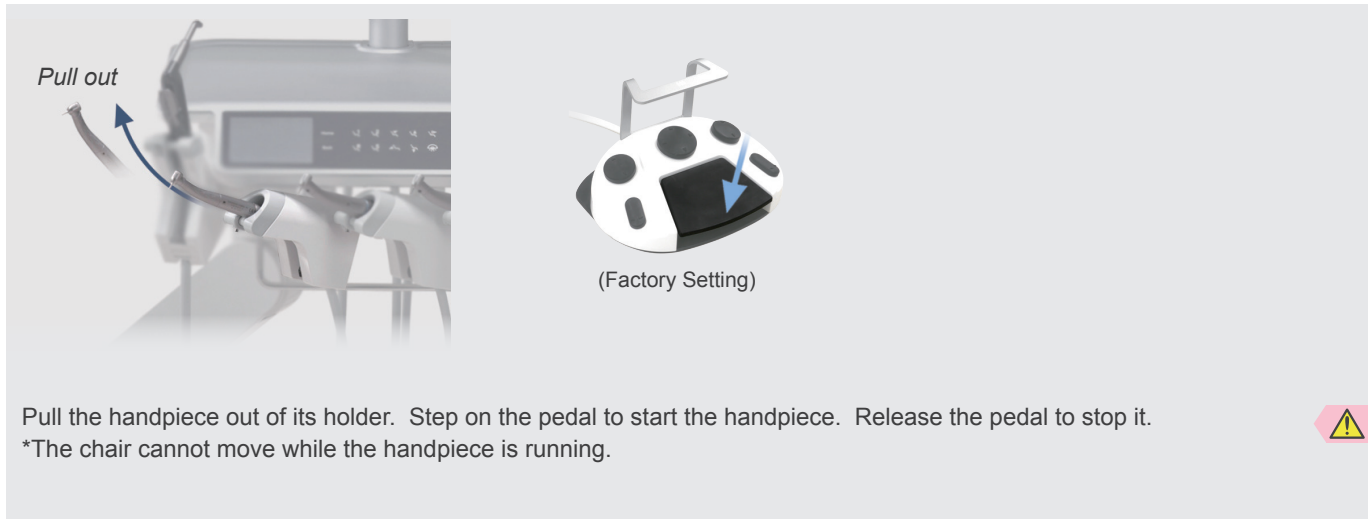

■ AT•AR Clean System

Air is blown through the head for about 10 seconds after the high pedal is released. This prevents cutting debris, saliva etc. from being drawn into the handpiece water and air tubes.

⚠ WARNING

- Always give a handpiece a light tug after connecting it to its tube to make sure it is securely attached. Otherwise air pressure could blow it off its tube and injure the patient.
- Check that the display for handpiece you are using appears in the operation panel. Also check its settings.
- Wait for the handpiece to come to a complete stop before taking it out of or putting it into the oral cavity.

Air Turbine Handpiece

■ Constant (Fixed) or Variable Speed

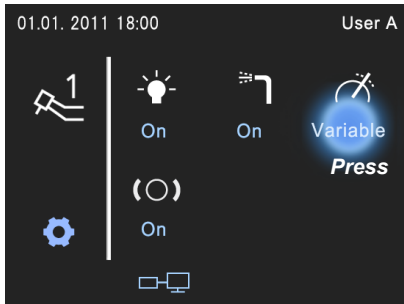

Select constant or variable speed by pressing the button in the System Display.

* This cannot be done while the handpiece is actually running.

■ Handpiece Light On, Off and Brightness

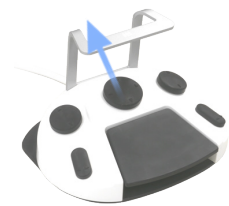
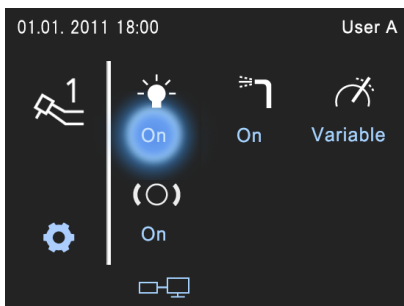

(Factory Setting)

Turn the light on and off with the button in the System Display or with the switch on the Foot Control.

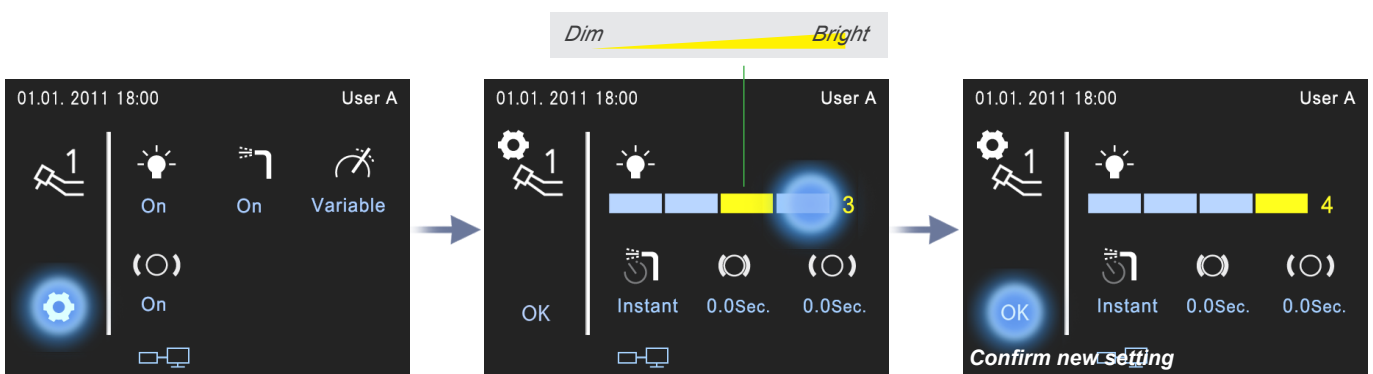

To adjust the brightness, press the gear-shaped icon in the lower left corner of the System Display. Select the brightness level and then press OK.

ⓘ The brightness of the light cannot be adjusted when using Morita's CP4-LD or CP4-W-LD coupling for the handpiece.

Air Turbine Handpiece

Turn Spray On and Off and Adjust Flow Volume



Turn the spray on and off with the button in the System Display or with the switch on the Foot Control.



The spray adjustment knobs are located underneath the tray.

Set Timing for Spray Delivery

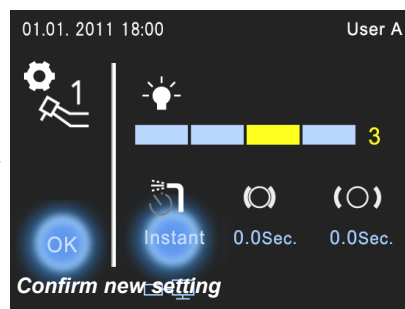
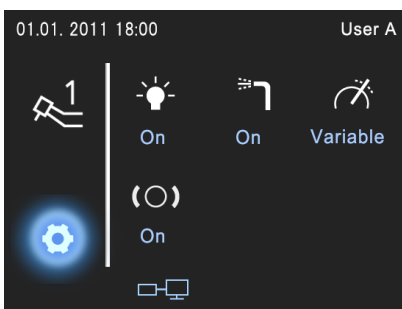

To adjust the spray timing, press the gear-shaped icon in the lower left corner of the System Display.

Instant: Spray emitted as soon as pedal is depressed.

Delay: Spray is emitted when pedal is depressed slightly more after the handpiece has already started to run.

CAUTION

- Using the handpiece without spray or with very little spray could cause the treatment area to heat up.

Air Turbine Handpiece

■ Handpiece Tube Catch

When the tube catch is turned on, it grips the tube for the air turbine and micromotor handpieces at the place where it comes out to reduce the stress its weight can exert on the dentist's wrist.

Turn the Tube Catch On or Off



(Common) (Separate)

Turning the catch on or off for handpiece no. 1 will turn it on or off for the all the others as well. However, the catch for handpiece no. 2 can be turned on and off separately.

Turn the tube catch on and off by pressing the button in the System Display.

Tube Catch Grip and Release Timing

Changing this for one handpiece will change it for all the other handpieces as well. Timing cannot be set separately for each handpiece.

Tube Grip Delay

Tube Release Delay

* Same as for tube release delay.

- Tube Grip Delay: Set time for catch to grip tube after pedal is depressed.
- Tube Release Delay: Set time for catch release after pedal is let up.

Micromotor Handpiece

* Refer to the separate user manual for the micromotor handpiece and the attachment.

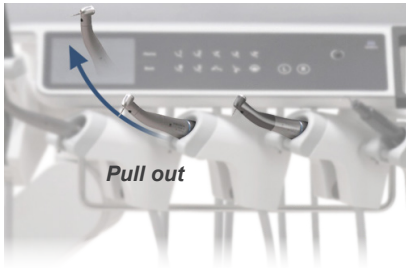
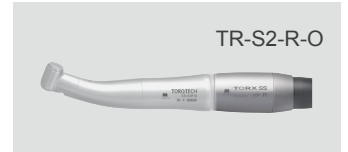

Blue icons are buttons that you can press.

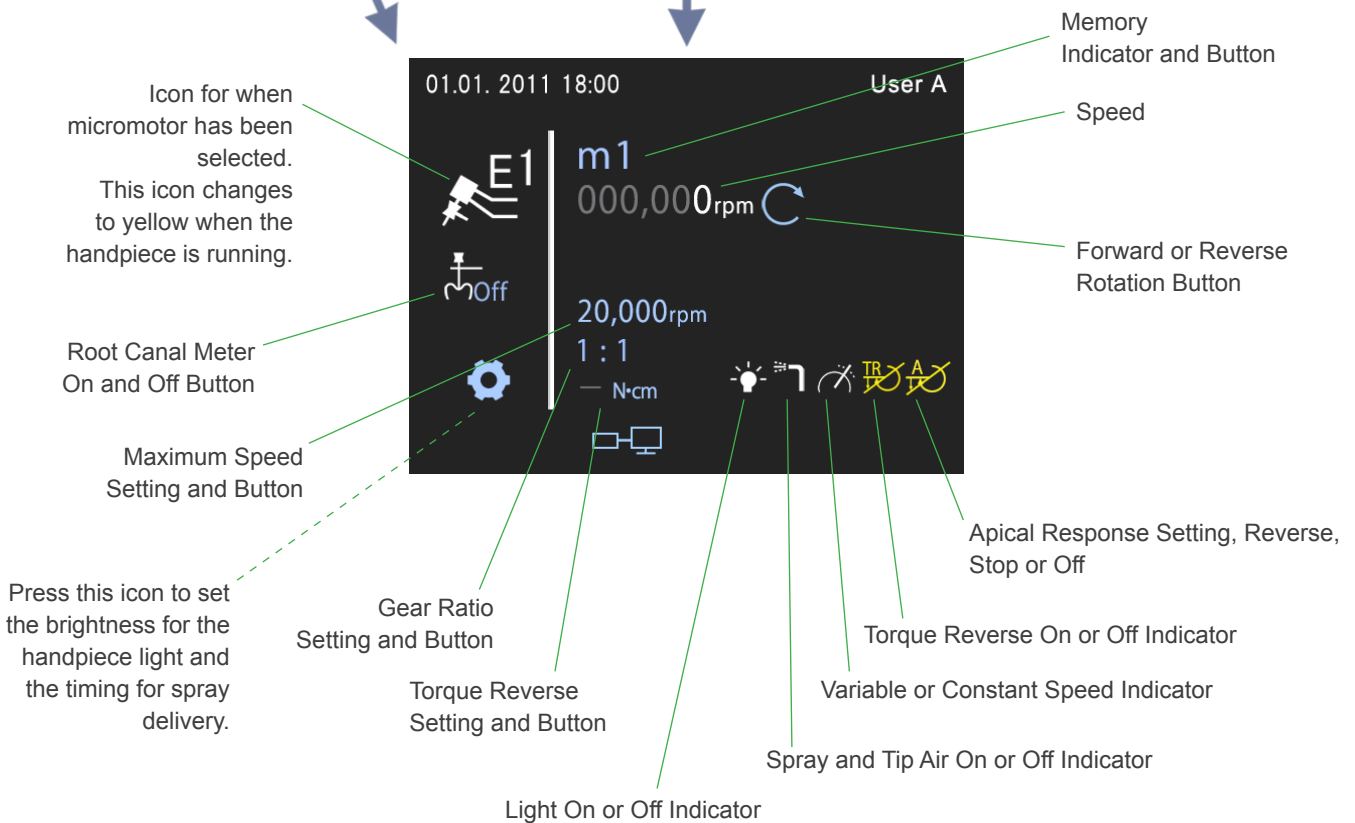

- ⓘ Maximum speed refers to the burr rotation speed not the motor speed.
- ⓘ When the CA-10RC-ENDO contra angle is attached, the handpiece light and spray are turned off. Also the gear-shaped icon for Additional Settings does not appear.

Micromotor Handpiece

■ Use

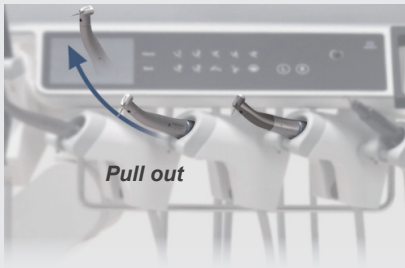

Pull the handpiece out of its holder. Step on the pedal to start the handpiece. Release the pedal to stop it.

* The chair cannot move while the handpiece is running.



■ Gear Ratio Settings

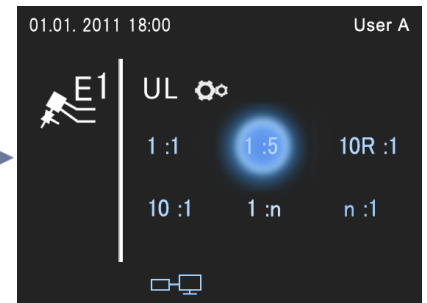
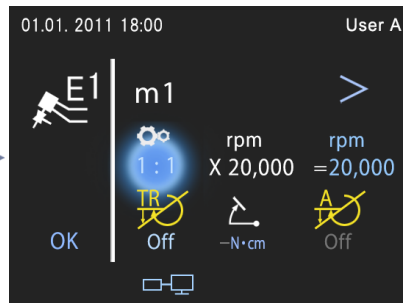
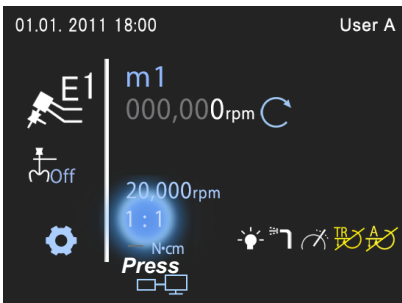

Enter the gear ratio for the attachment being used.



⚠ WARNING

- Always give a handpiece a light tug after connecting it to its tube to make sure it is securely attached. Otherwise air pressure could blow it off its tube and injure the patient.
- Check that the display for handpiece you are using appears in the operation panel. Also check its settings.
- Wait for the handpiece to come to a complete stop before taking it out of or putting it into the oral cavity.
- If you fail to enter the gear ratio for the attachment correctly, the running speed and the maximum speed shown in the display will not be correct.

⚠ CAUTION

- Follow manufacturers' recommendations concerning rotation speed for burs, points and files.

Micromotor Handpiece

Handpiece Light On, Off and Brightness

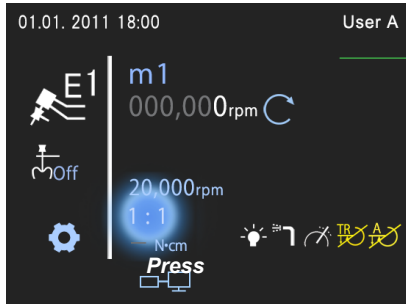

* When the main micromotor display is on, turn the light on and off with the switch on the Foot Control.



(Factory Setting)

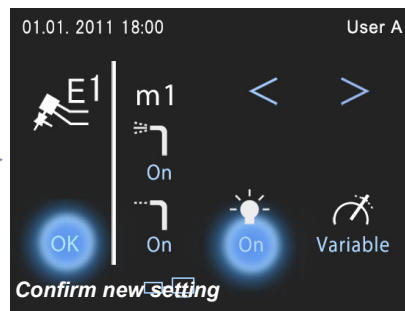
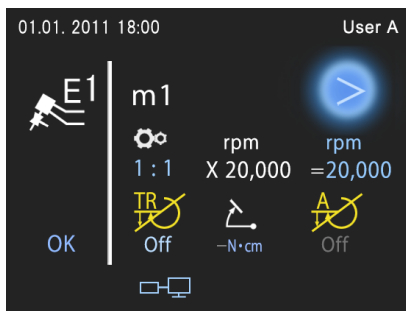

Turn the light on and off with the button in the System Display.

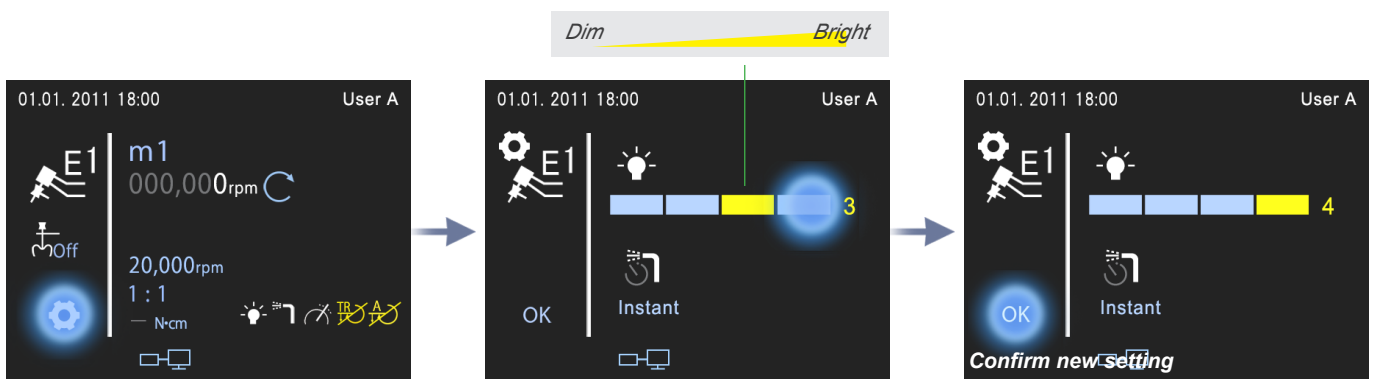

To adjust the brightness, press the gear-shaped icon in the lower left corner of the System Display. Select the brightness level and then press OK.

Micromotor Handpiece

Handpiece Spray On, Off and Flow Volume

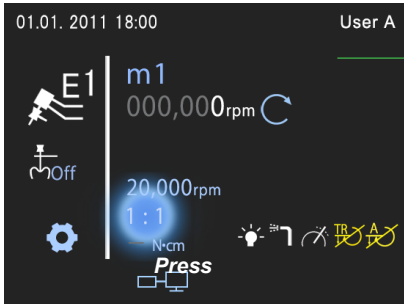

* When the main micromotor display is on, turn the spray on and off with the switch on the Foot Control.



(Factory Setting)

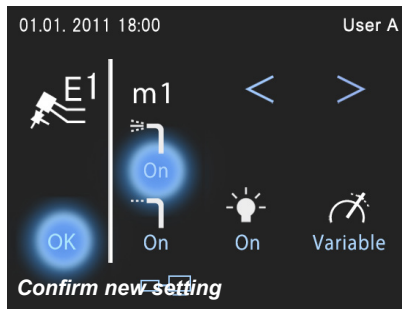
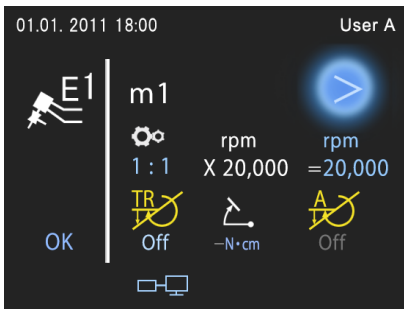

Turn the spray on and off with the button in the System Display.



The spray adjustment knob is located underneath the tray.
Turn the knob in the direction shown by the arrow to increase the flow.

CAUTION

•Using the handpiece without spray or with very little spray could cause the treatment area to heat up.

Micromotor Handpiece

Tip Air On and Off

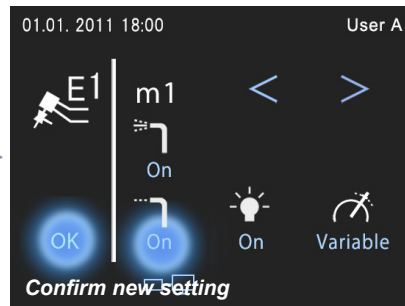
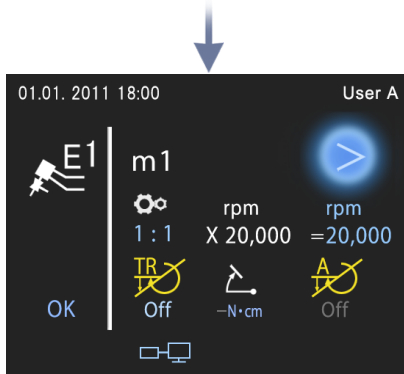

Spray Timing

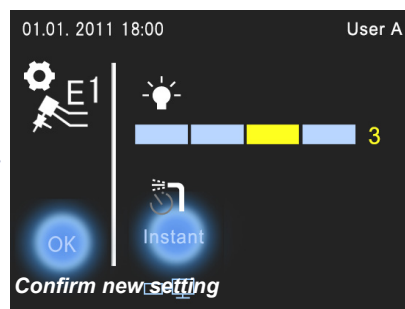
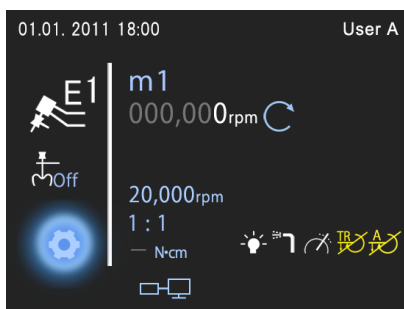

To adjust the spray timing, press the gear-shaped icon in the lower left corner of the System Display.

Instant: Spray emitted as soon as pedal is depressed.

Delay: Spray is emitted when pedal is depressed slightly more after the handpiece has already started to run.

Micromotor Handpiece

Select Forward or Reverse Rotation

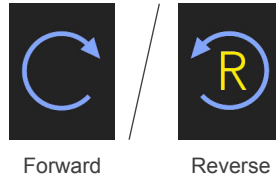

Press the button in the System Display.

⚠ Do not press this button when the motor is actually running.



Memory

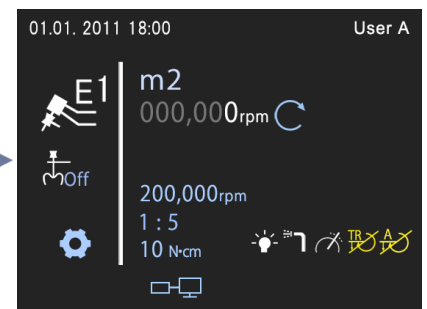
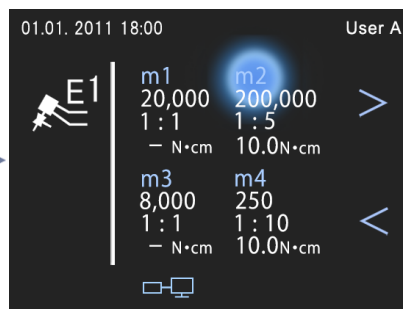
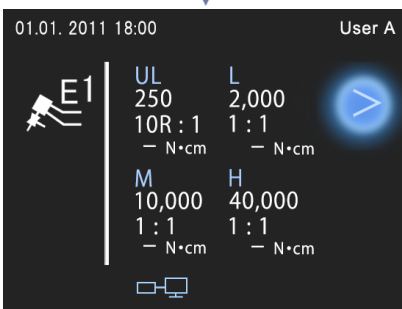
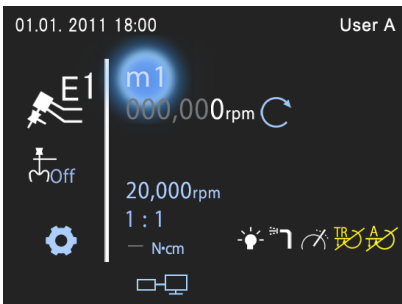

Select UL, L, M, or H, or select any memory from m1 to m6.

⚠ CAUTION

- Visually check the rotation direction before using the handpiece.
- The forward and reverse rotation setting cannot be memorized.

Micromotor Handpiece

Select Constant (Fixed) or Variable Speed

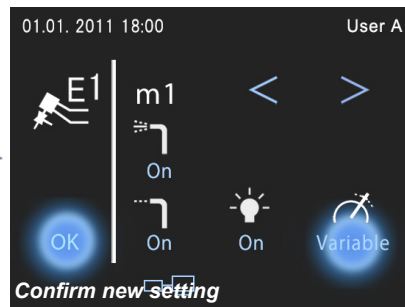
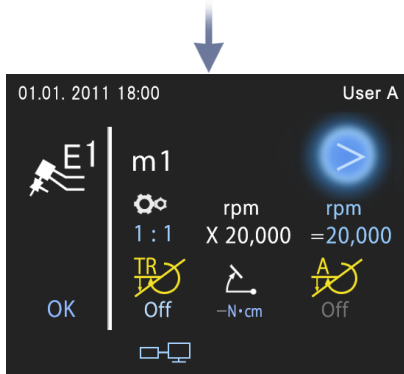
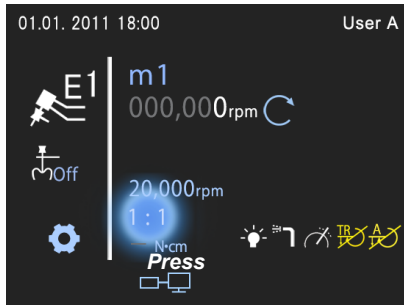

Use the System Display to select constant or variable speed.

* The settings cannot be changed while the motor is running.

⚠ Variable speed cannot be selected when the torque reverse or the apical response reverse or stop) is turned on.

Micromotor Handpiece

■ Gear Ratio Settings

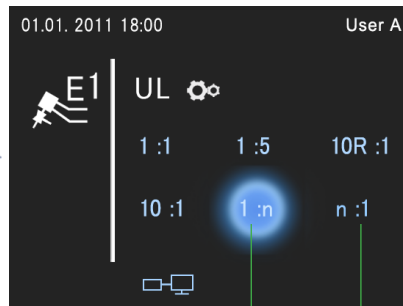
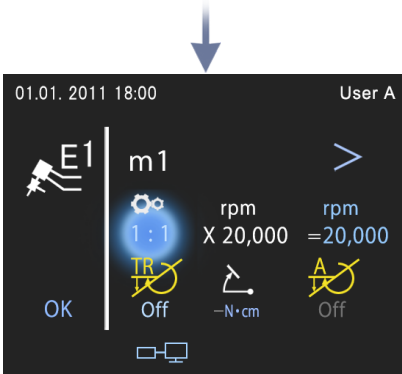
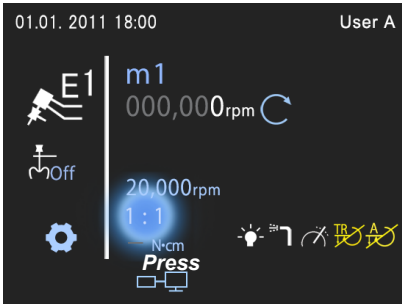

* This is the same to set the speed reduction ratio.

ⓘ The speed up ratio can be set as high as 1:10 and speed reduction can be set as low as 99.9:1.

■ Speed Range Settings

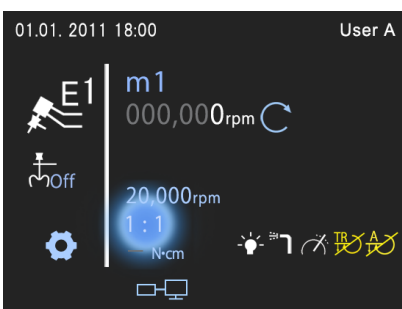

- ⓘ The speed range for the endodontic contra angle CA-10RC-ENDO can only be set from 10 to 2,000.
- ⓘ Speed cannot be set higher than 2,000 if the torque reverse or the apical response (reverse or stop) is turned on.
- ⓘ Make sure gear ratio is set correctly.

⚠ WARNING

- If you fail to enter the gear ratio for the attachment correctly, the running speed and the maximum speed shown in the display will not be correct.

Micromotor Handpiece

Torque Reverse On and Off

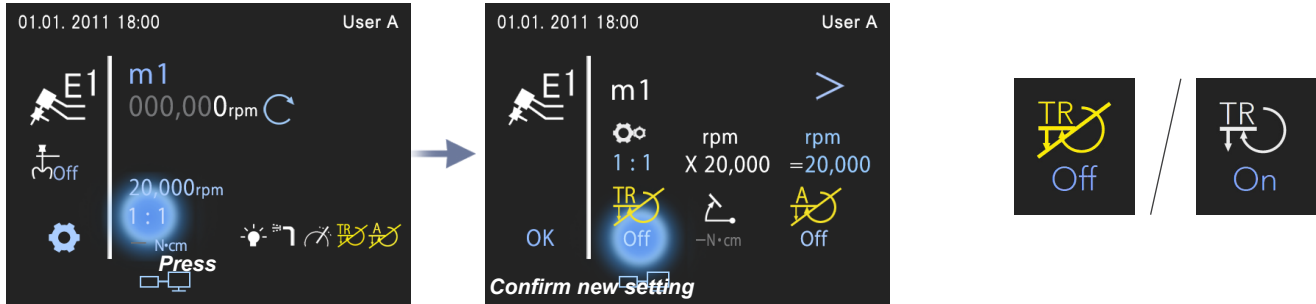

The file will automatically reverse its rotation if the load exceeds the set value. This reduces the risk of the file jamming or breaking.

ⓘ The torque reverse cannot be turned on if the gear ratio is set for speed up or if the speed reduction setting is lower than 10:1.

Torque Reverse Setting

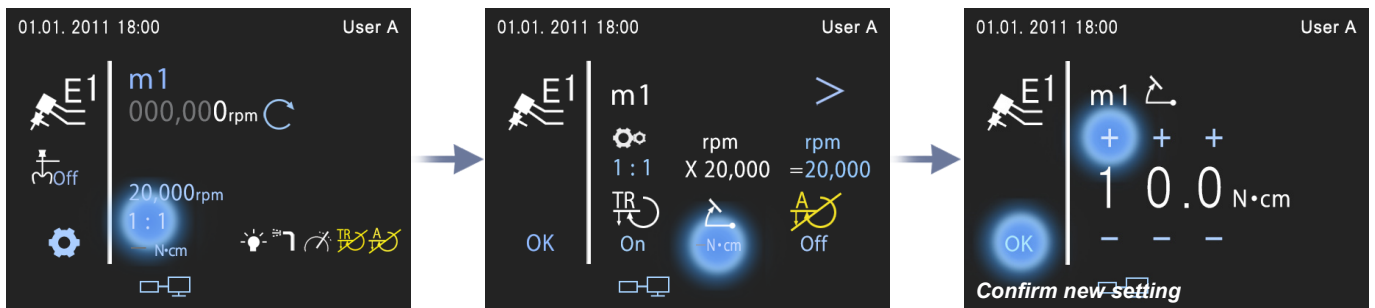

ⓘ Setting can be changed only when torque reverse is turned on.

⚠ WARNING

- The actual load that triggers the torque reverse depends somewhat on the attachment being used as well as the setting. Users should start with a low setting and increase it only after seeing how it works.
- Nickel-Titanium files break rather easily and should be used with great care.
- Torque reverse values are calibrated for TorqTech attachments. Values for other attachments may be somewhat different.
- If the torque reverse settings seems to be too strong or too weak, change it.

⚠ CAUTION

- If the motor or the contra angle is old and somewhat worn out, the torque reverse might be triggered as soon as the motor starts to run. In this case, raise the value for torque reverse high enough so that the motor will not go into reverse immediately and then add the amount of load you wish to use to trigger the torque reverse.

Micromotor Handpiece

Alarm Sound for Torque Reverse

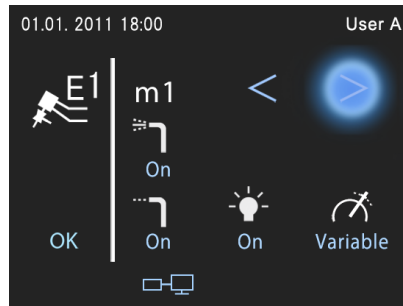
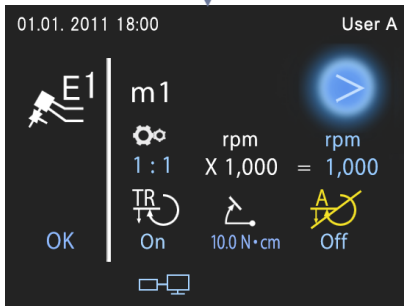
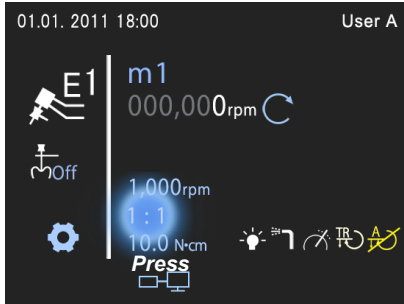

Micromotor Handpiece

- * The root canal meter can be turned on and off if the chair is equipped with root canal measurement capability and you are using the TR-S2-R-O.
- * The TR-S2-R-O can measure root canals.
- * If the unit is equipped with the optional canal measurement capability, MORITA's speed-reduction CA-10RC-ENDO contra angle attachment can be used for endodontic treatment, and it will have Apical Stop and Apical Reverse capability.
- * Refer to the separate user manual for the micromotor handpiece, the attachment and the root canal measurement device.

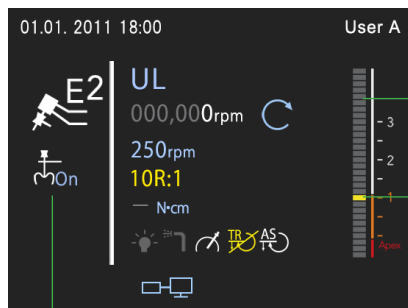
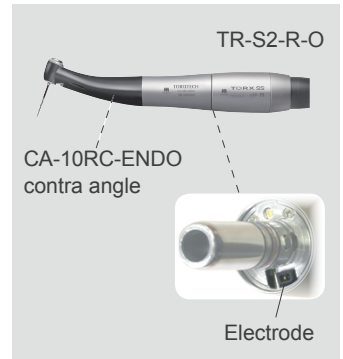

Root Canal Meter
(only appears when turned on)

Flash Bar

Root Canal Meter On and Off Button

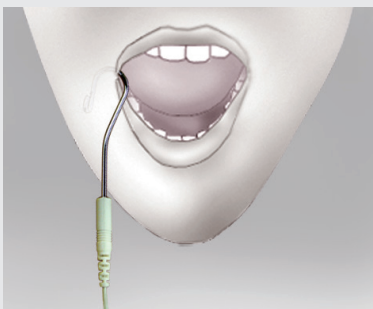

If you use Apical Stop and Apical Reverse setting with the TR-S2-R-O, hook the contrary electrode in the corner of the patient's mouth and line up the connector for the probe cord with its jack on the shoulder and plug it straight in.

Micromotor Handpiece

Flash Bar Setting

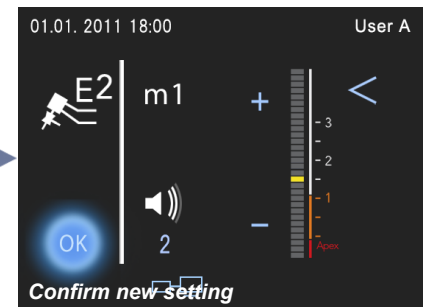
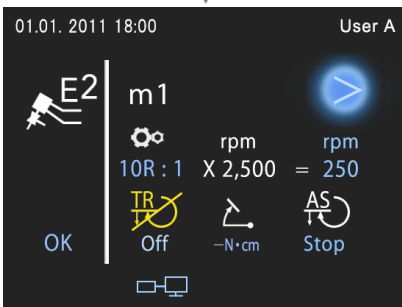
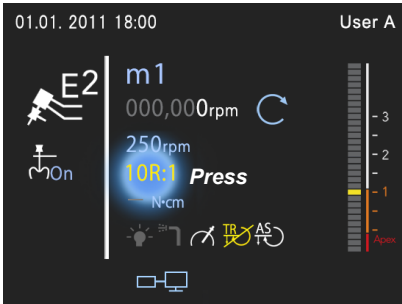

* Set anywhere from 2 to Apex.

Apical Response

* Only for the combination of the TR-S2-R-O and contra angle with canal measurement capability.

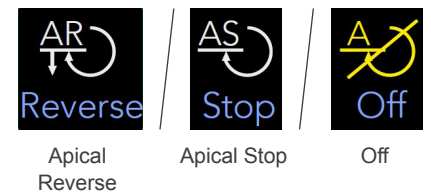
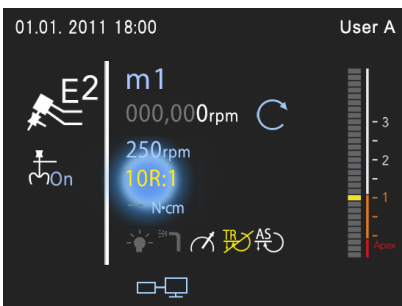

Apical Reverse: File reverses rotation when it reaches the Flash Bar.

Apical Stop: File stops when it reaches the Flash Bar.

ⓘ Refer to the separate user manual for the Root ZX mini U (Built-in Model for Soaric) for instructions on measuring canals.

Micromotor Handpiece

Apical Reverse and Apical Stop Beeper Volume

* Only for the combination of the TR-S2-R-O and contra angle with canal measurement capability.

The process is shown in three steps:

- The main menu displays '10R:1 Press'.
- The settings menu shows '10R:1' with 'TR' and 'AS' options.
- The volume adjustment screen shows a volume slider and 'OK' and '2' buttons.

Volume levels are indicated by speaker icons: 1, 2, and Off.

ⓘ Changing the volume of the beeper for apical reverse or stop will also change the volume of the beeper for torque reverse.

Threeway Syringe

■ Use

Without Light

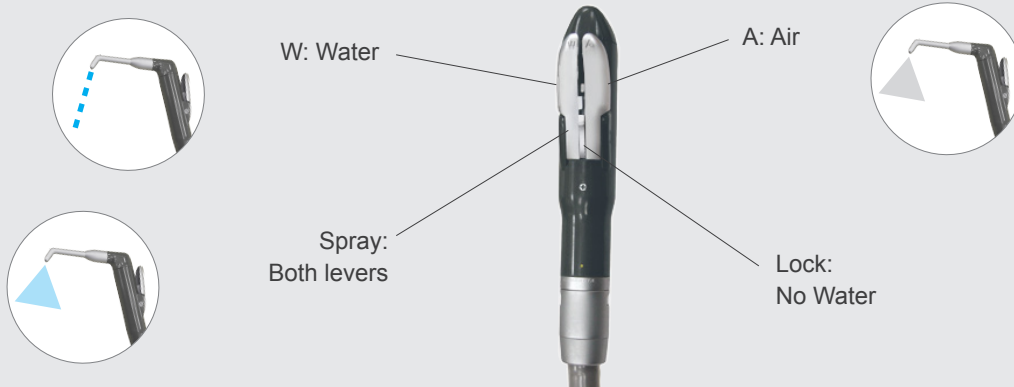

With Light (Option)

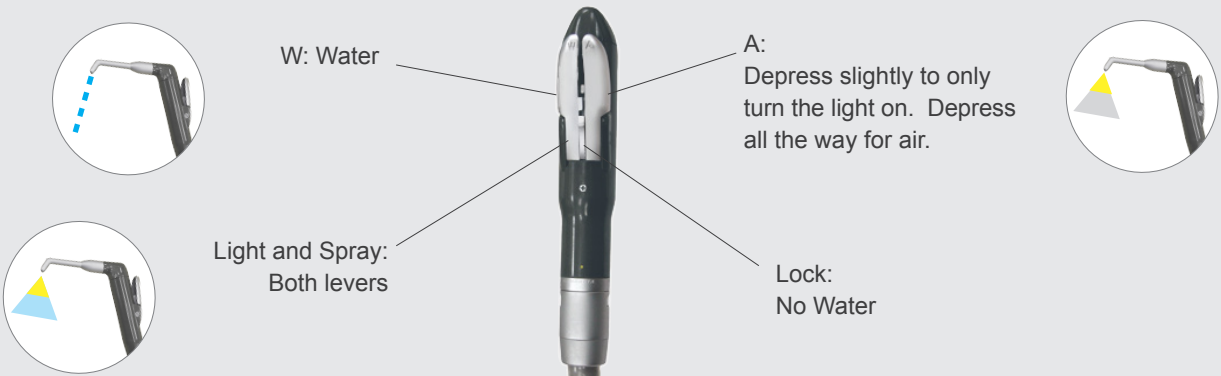

* Always lock the water lever before putting the syringe away to prevent leaking.

Threeway Syringe

■ Removing and Inserting the Nozzle

Without Light

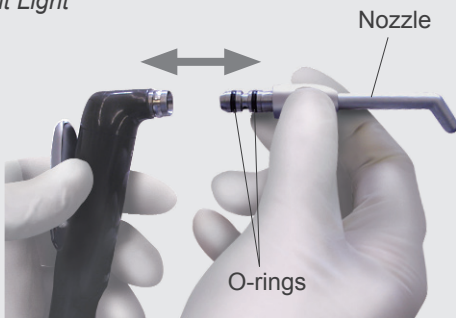

With Light

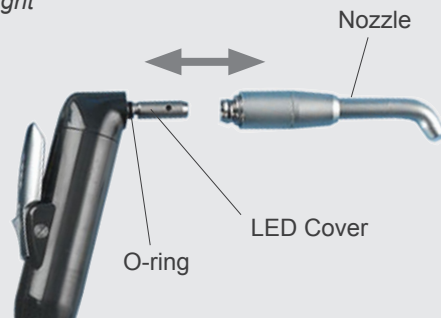

Push the nozzle into the syringe or pull it out.



- ⚠ A little water may come out of the threeway syringe when the air lever is pressed right after the nozzle has been attached. Press the air lever 2 or 3 times to expel all the water.
- ⚠ Coat the nozzle's O-rings with vaseline if it is hard to attach and remove.

■ Putting On the Syringe Case

Without Light

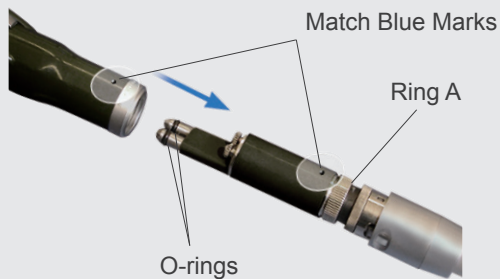

Match the blue marks on the case and body, and push them until they click together. Make sure the syringe case is securely connected.



- ⚠ Make sure the Ring A in the photo is securely tightened up.
- ⚠ Coat the O-rings with vaseline if it gets hard to take the case off and put it back on.

With Light



Match the yellow marks on the syringe and tube connector and push them together until they click. Make sure the syringe is securely connected.



⚠ CAUTION

- Make sure there is an audible click when putting the nozzle on the threeway syringe and that the nozzle is securely fixed to the syringe.
- Remember that the LED and its cover are extremely hot right after the LED has been turned off. Do not touch these parts; they could cause a burn.
- Make sure the threeway syringe case and body are securely attached to each other. Otherwise, the case could slip off when you take it out of its holder.
- If the nozzle gets plugged up with debris, it could be blown off the end of the syringe during use and injure someone.

Threeway Syringe

■ Taking Off the Syringe Case

Without Light

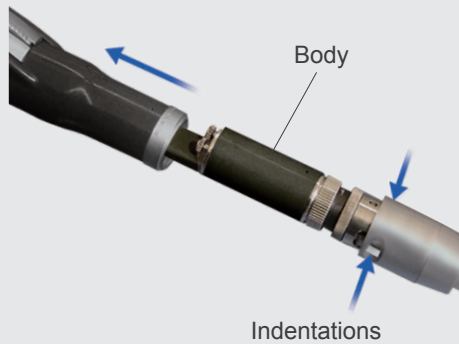

With Light

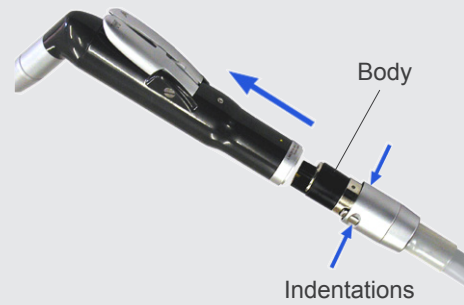

Press down on the indented part of the syringe tube connector and pull the syringe case off the body.

■ Turn Light On or Off

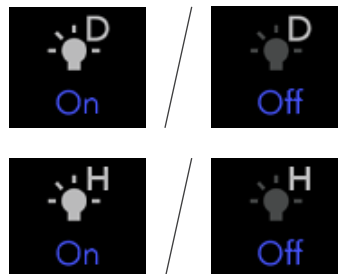
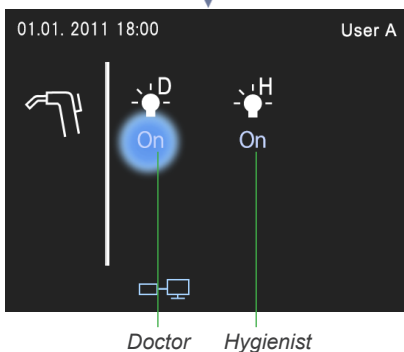

Pull out the syringe and turn the light on or off using the System Display.



⚠ CAUTION

- If you use just the light for too long, the nozzle could heat up and cause a burn. If the nozzle gets too hot, blow air through it for at least 30 seconds.

Vacuum Syringe

■ Use

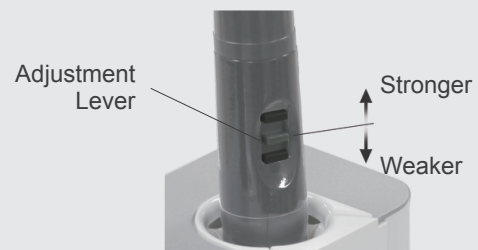

The strength of the vacuum can be adjusted with the lever on the syringe.

The vacuum syringe begins to operate when it is pulled out of its syringe holder, and stops a few seconds after it is returned to its holder.

It can also be turned on and off with the vacuum switch on the assistant side.

It is also possible to operate with the foot control switch by changing its settings. (→ see page 80)

* When the syringe is used continuously and sucks in matter faster that it can drain out of the tank, the tank will fill up and the float switch will shut off the vacuum. If this happens, put the vacuum syringe in the its holder and wait until the tank has drained.

■ Vacuum Tips



Turn the adapter and slide it in (or pull it out) and then slide the vacuum tip in (or pull it out).

⚠ Coat the O-ring inside the vacuum syringe with a little vaseline if the vacuum tip is hard to put in and take out.

Vacuum Syringe

■ Putting on and taking off the syringe body (screw type)

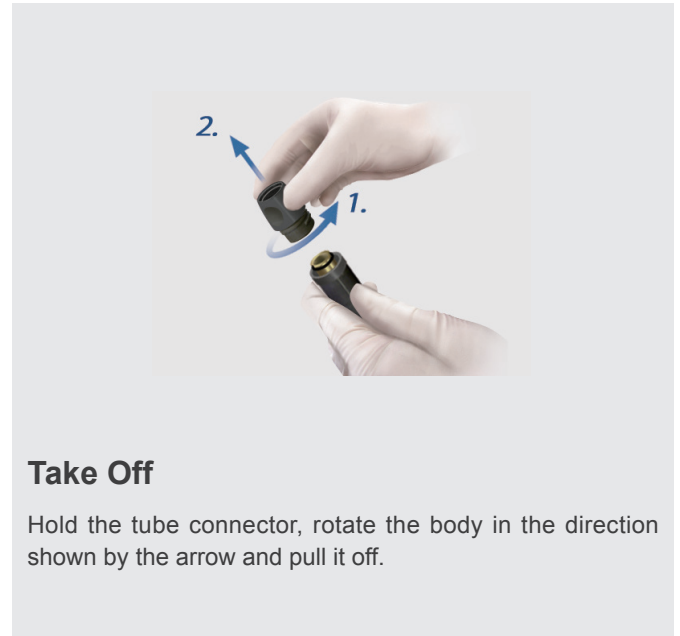
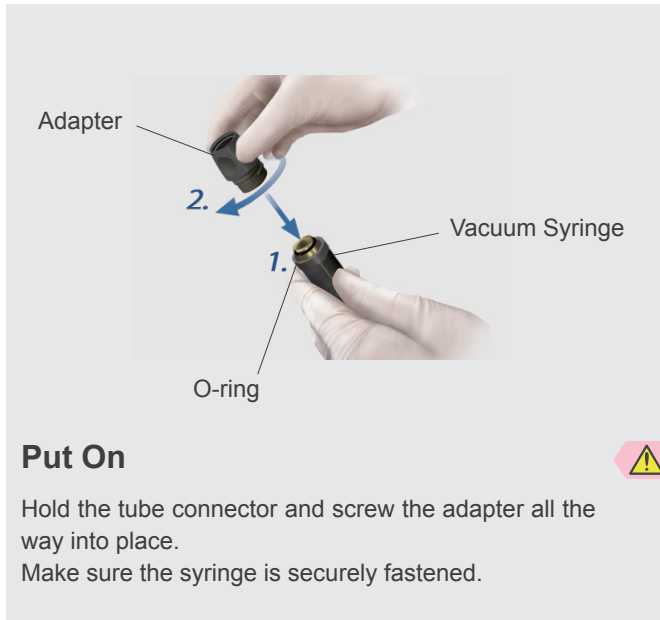

⚠ Always turn the adapter to take it off and put it on. Turning the tube connector could damage it.

WARNING

- Make sure the syringe body is securely attached to its tube; otherwise it might come off when you pull it out.

Saliva Ejector (Option)

■ Use



The diagram shows the saliva ejector in its holder on the left. A blue arrow points upwards from the ejector tip. On the right, a close-up of the adjustment lever is shown with labels 'Adjustment Lever', 'Stronger' (upward arrow), and 'Weaker' (downward arrow). Below the holder is a control panel with icons for various functions, including a hand icon pointing to the ejector switch.

Adjustment Lever

Stronger

Weaker

The strength of the vacuum can be adjusted with the lever on the syringe.

The ejector starts when it is taken off its holder and stops when it is put back.

It is also possible to press the Ejector Switch to operate it when it is off its holder.

■ Ejector Tip and Body

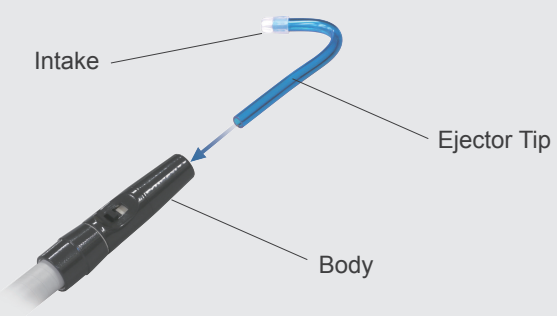

The diagram shows the ejector tip and body assembly. Labels include 'Intake' at the top of the blue tube, 'Ejector Tip' at the curved end, and 'Body' at the black handle.

Intake

Ejector Tip

Body

Simply slide the tip into the body or pull it out.

⚠ Make sure the tube and ejector body are properly and securely connected.

⚠ WARNING

- Use a new ejector tip for each patient.

Ultra Sonic Scaler (built-in model) (Option)

* Refer to the separate user manual for the Solfy F (Built-in Model for Soaric).

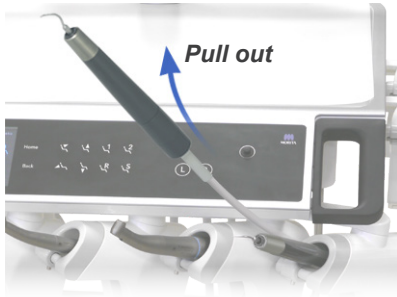

Blue icons are buttons that you can press.

Vibration Mode (Normal, Soft, Off)
Current selection mode is displayed.
This icon changes to yellow when the scaler is in use.

Press this icon to change vibration mode and light brightness.

Turn Spray On and Off

Turn Handpiece Light On and Off

Power Mode
Boost: Crown removal
Scaling: Scaling treatment
Endo: Endodontic treatment
Perio: Periodontal treatment

Power Recommendation	
Boost	21 – 25
Scaling	11 – 20
Endo	6 – 10
Perio	1 – 5

ⓘ For detailed information about scaler tip attachment, refer to the accompanying booklet: Tip Guide.

Ultra Sonic Scaler (built-in model) (Option)

■ Use

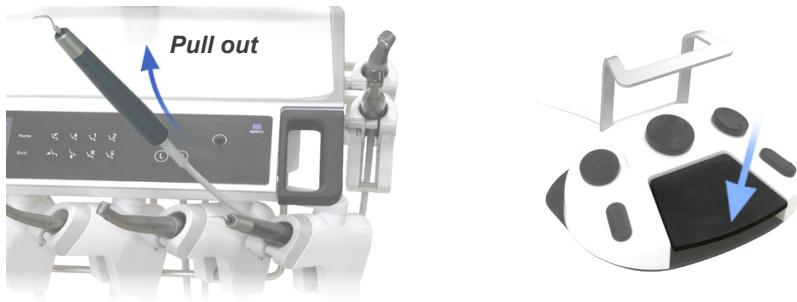

Step on the pedal on the foot control to vibrate the scaler tip. Release the pedal to stop.

* The chair cannot move while stepping on the pedal (the scaler is in operation).



ⓘ Check that the handpiece is connected to the tube thoroughly and make sure the scaler tip is tighten up properly before vibrating the scaler.

WARNING

- Check that the system display is for the scaler and also check its settings.
- Wait for the scaler tip to stop vibrating before putting it into or taking it out of the patient's oral cavity.

Implant Motor System [Bien-Air: MX-i and MX-i LED Series] (Built-in model) (Option)

* Refer to the separate user manual for the Implant Motor System (Soaric Built-in Model).

Implant Motor System



LED Light Cure (built-in model) (Option)

* Refer to the separate user manual for the Pencure 2000 (Built-in Model for Soaric).

■ Battery Charging

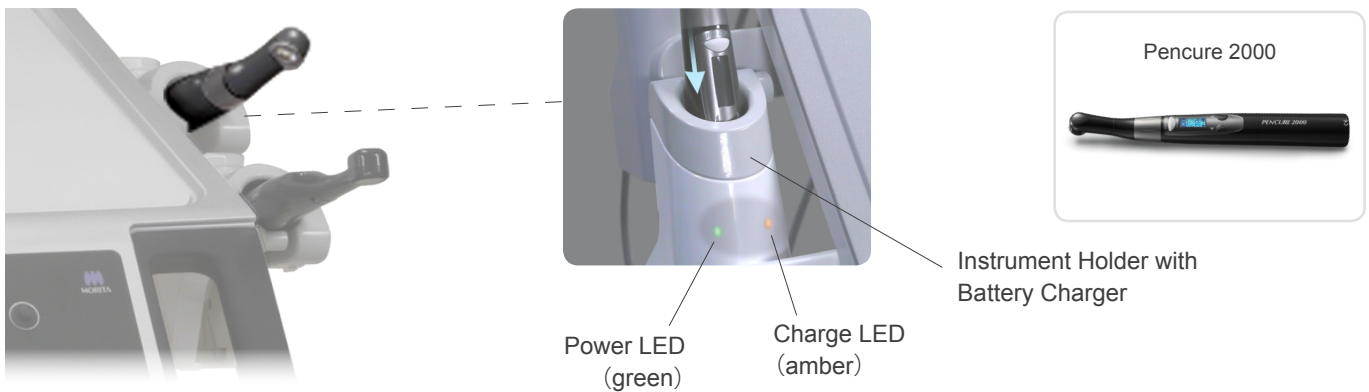

After use, put the handpiece back in its holder and its battery will be charged. The amber charge LED will light up.

* If the power LED is red, the battery will not be charged. See if there is debris, dust, metal fragments etc. on the end of the handpiece or the inside of its holder. If so clean the handpiece and its holder by wiping them with a piece of gauze dampened with ethanol.

■ Use

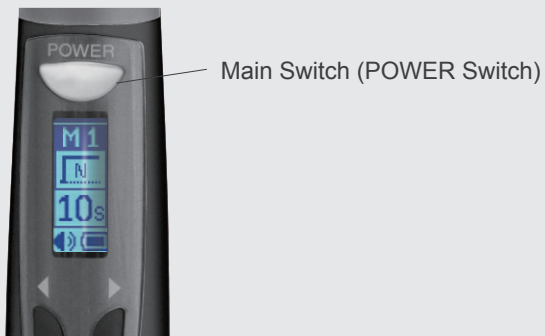

Turn on the Main switch. The Standby Display will appear.

Root Canal Measurement Device (built-in model) (Option)

* Refer to the separate user manual for the Root ZX mini U (Built-in Model for Soaric).



Blue icons are buttons that you can press.

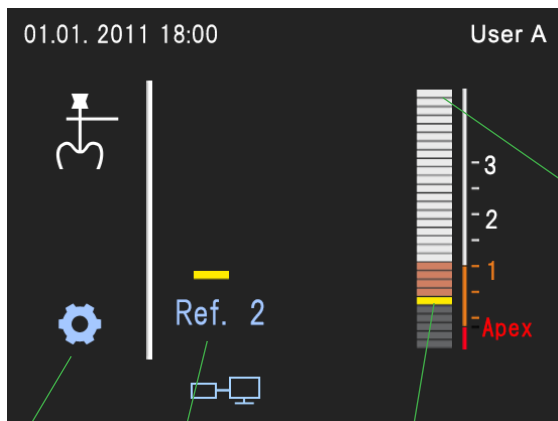

Press this to change settings for the beeper volume and the reference numbers.

Reference Nos.
Press this to select reference number 1, 2, or 3.

Flash Bar
Use this to estimate the working length of the canal.
Set it anywhere from 2 to Apex.

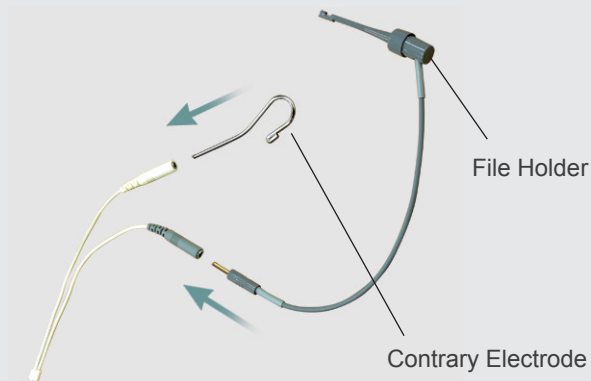
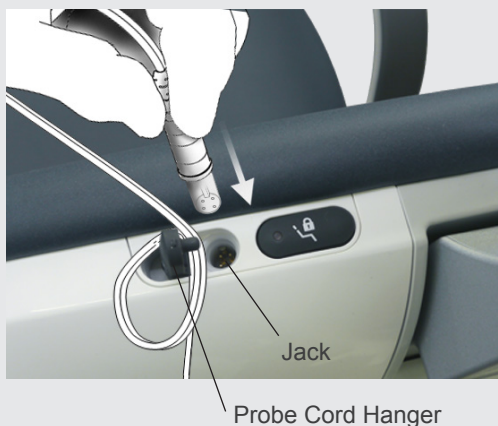

Line up the connector for the probe cord with its jack on the shoulder and plug it straight in.

⚠ When the root canal measurement device is in use, you cannot operate the chair and the mouse-like cursor control (option).

Basin

■ Basin Swing Range (For Auto Swing Basin (option))

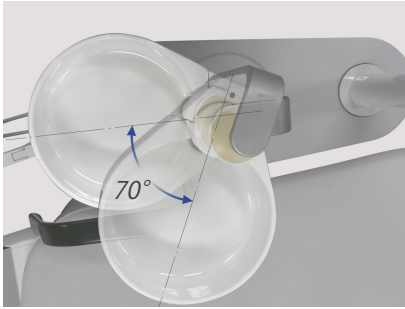

The basin swing range is 70 degrees.



When you press auto position switch S, the backrest will come up into the mouth rinsing position. At the same time, the basin will swing over towards the patient. The basin will return to its original position when you press switch S again.



⚠ Do not grab or hold onto the fountain; this could damage it and result in leaking or an accident.

⚠ CAUTION

- Make sure the patient is not holding or touching the basin before you raise the backrest.
- Replace the basin immediately if it is cracked or chipped.
- Do not drop anything on the basin.

Basin

■ Cup Filler

Auto Cup-filler

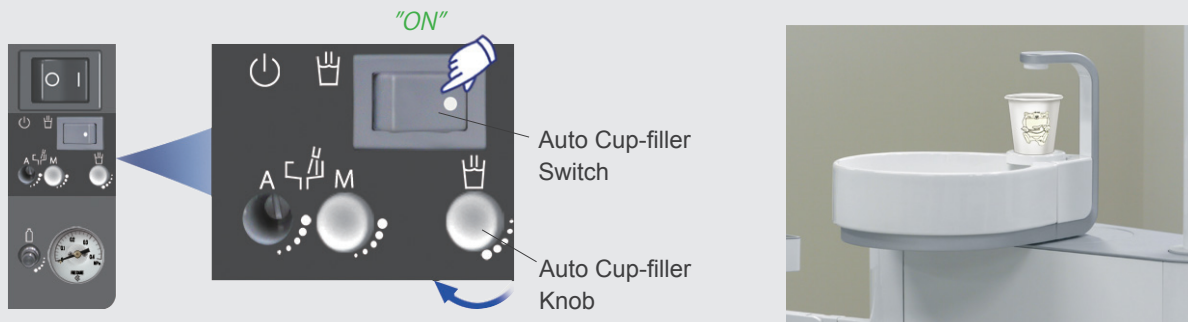

Turn on the Auto Cup-filler Switch.

A cup will be automatically filled with water when it is placed on its stand.

- Adjust the amount of water the auto filler delivers with the Auto Cup-filler Knob. Turn the knob in the direction shown by arrow in the photo above to increase the amount.
- When the Auto Cup-filler is used, the basin is rinsed for 15 seconds after the cup is filled.

* Paper cups may also be used. (Use the same type as those originally provided.) Transparent or partially transparent cups and cups of a different size may NOT be detected by the light sensor and, as a result, may not be filled with water.

* If a full cup of water is left in place and the main switch is turned off and on again, a little water will flow into the cup until the water level is detected.

Manual Cup Filling



Turn off the Auto Cup-filler Switch.

Put a cup on its stand and then press the Cup Filler Switch on the assistant's side. Water will fill the cup as long as the cup filler switch is being held down.

Basin

Basin Rinsing

Auto Rinsing

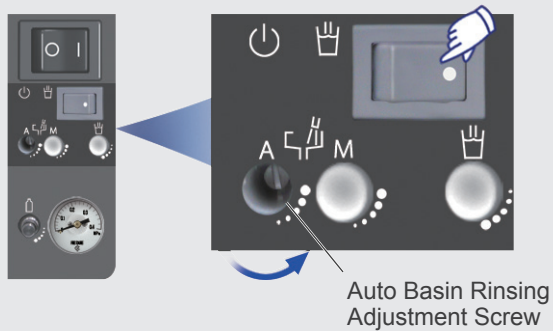

When the Auto Cup-filler is used, the basin is rinsed for 15 seconds after the cup is filled.

Turn the Auto Basin Rinsing Adjustment Screw in the direction shown by arrow in the photo above with a screwdriver to increase the amount.



When the Basin Rinsing Switch on the assistant's side is pressed, the basin is rinsed for 15 seconds. Press the switch again to turn the rinsing off manually.

* When the switch is being held down more than 2 seconds, the basin is rinsed until the switch will be released.

Manual Rinsing

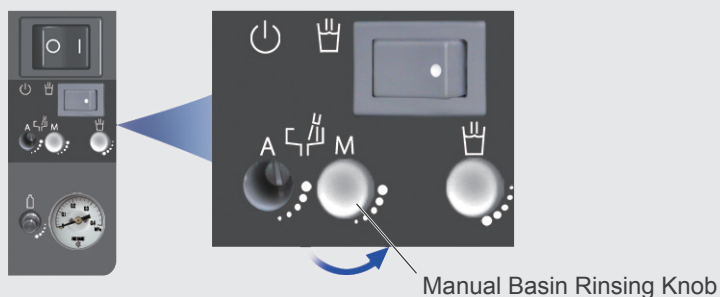

Turn the Manual Basin Rinsing Knob in the direction shown by arrow in the photo above to rinse the basin.

Operating Light

* Refer to the separate instruction manual provided for this instrument.

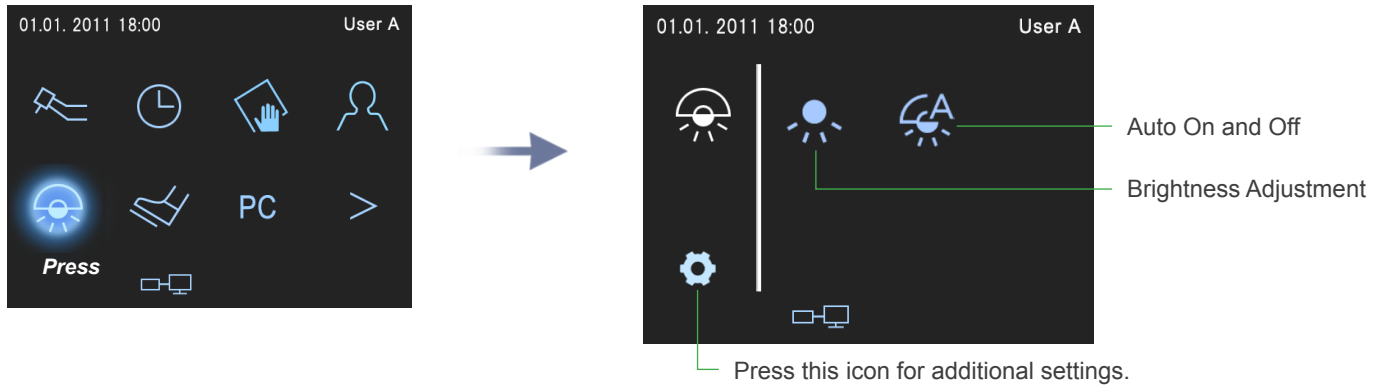

■ Use



Hold your hand in front of the sensor to turn the light on and off.

You can also turn it on and off with a switch on the foot control or the switches on the operation panels.

ⓘ If the sensor for the operating light has been disabled in the settings panel, the light can be turned on and off with its switch in the operation panel or the one on the foot control.

Operating Light

Brightness Adjustment

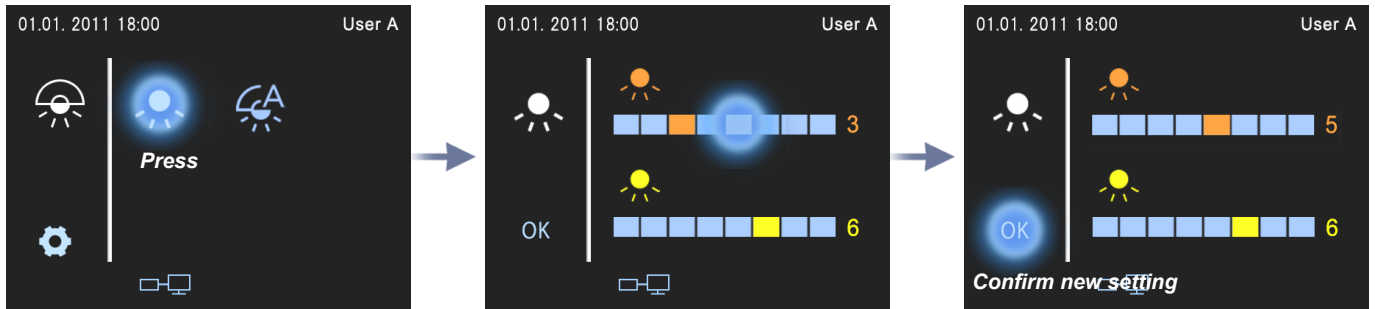

Set the brightness by touching the screen.

Two brightness levels can be memorized. Use the less bright level to keep from polymerizing (hardening) resins.

Hold down the switch on either one of the operation panels until a beep sounds to switch from one brightness level to the other.

Auto Light On and Off

This turns the light on and off automatically when the auto positioning switch are pressed.



Auto On: Lights up when auto position switch is pressed.

Auto Off: Goes out when auto position switch is pressed.

Deactive: Disabled. Turn light on and off manually.

Sensor Settings

The sensor turns the operating light on and off when you wave your hand in front of it. It can be disabled with a switch on the settings panel. It is also possible to operate with the foot control switch. (→ see page 80)



(3) System Display Home Page Icons

Timer

■ Start Timer

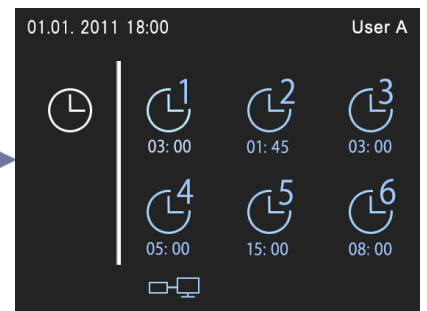
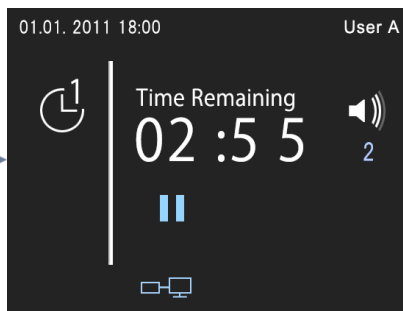
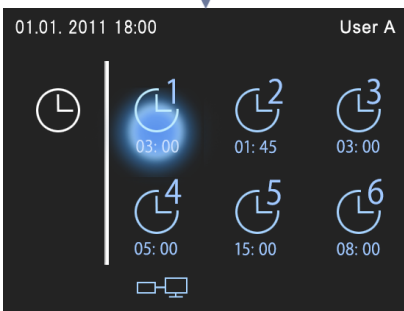
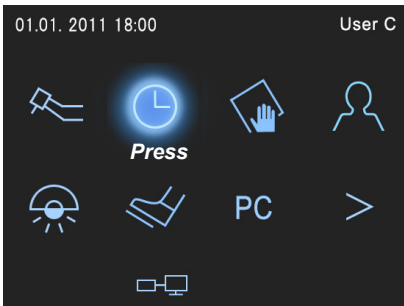

Alarm sounds when time is up.

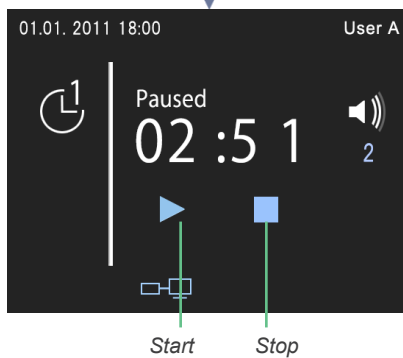

Press Stop to go back to the Start Timer display.
Press Home to go to the Home Page.

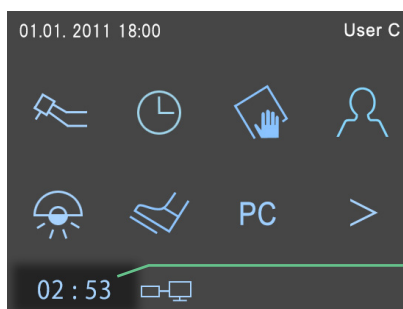

If you go to the Home Page, the countdown timer will appear in the lower left corner.

Timer

■ Set the timer

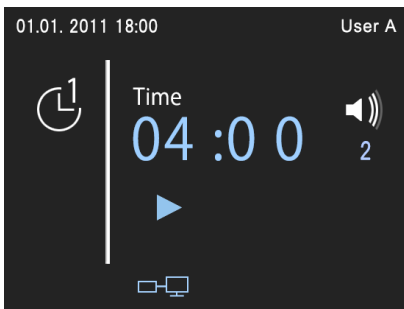

■ Set Alarm Volume

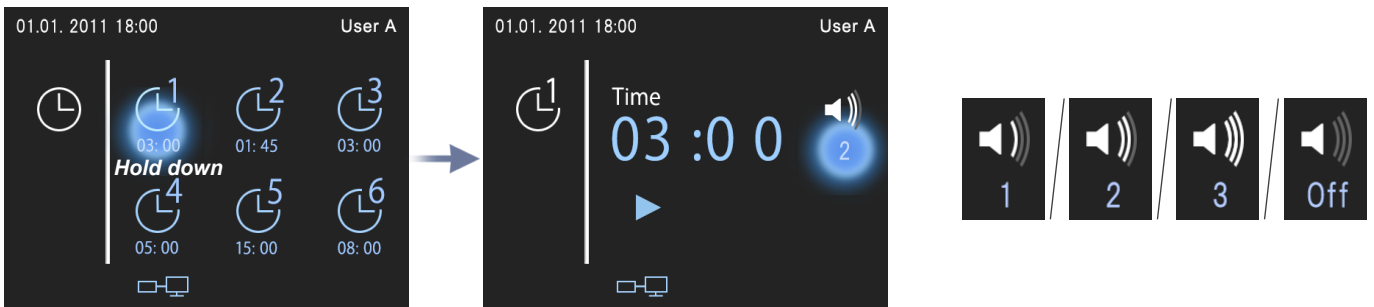

Maintenance

Turn the automatic tank rinsing function on or off. When turned on, the vacuum tank will be automatically rinsed out when the power is turned on and when the R Position switch is pressed.

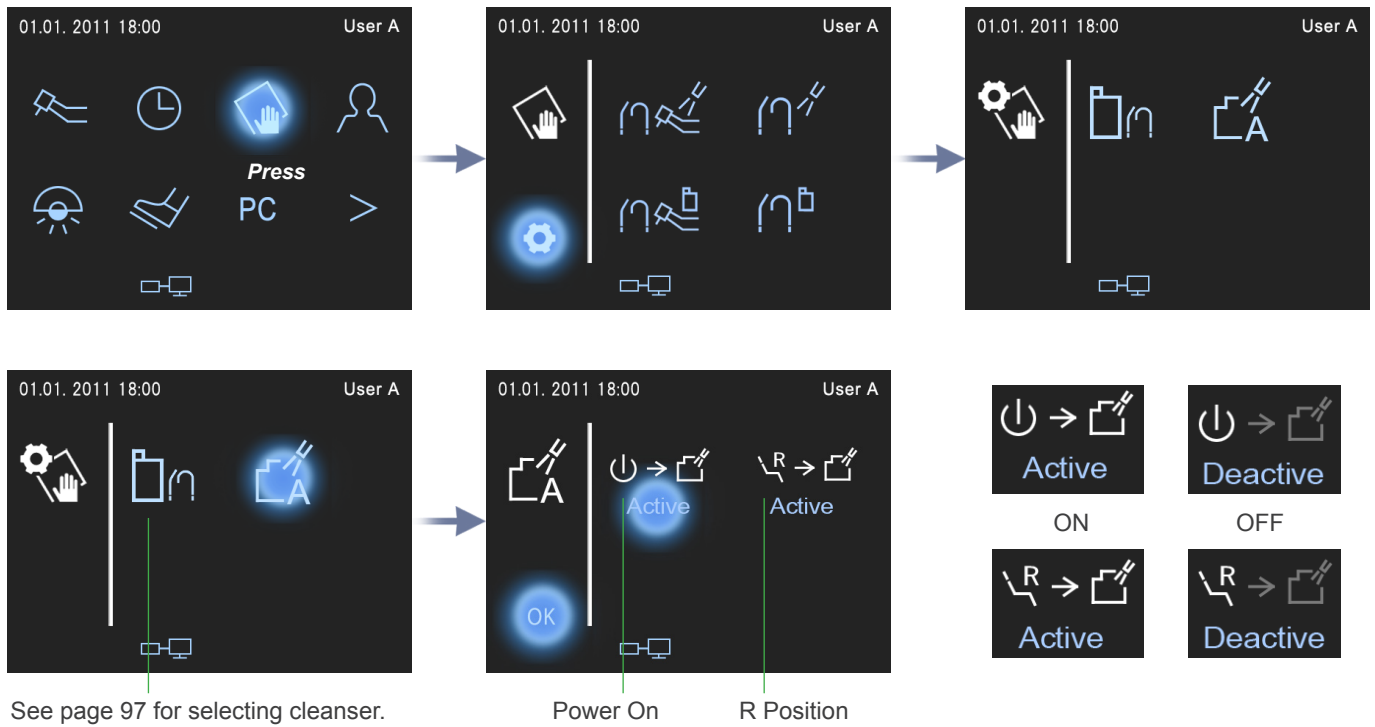

User Registration

Change user name.

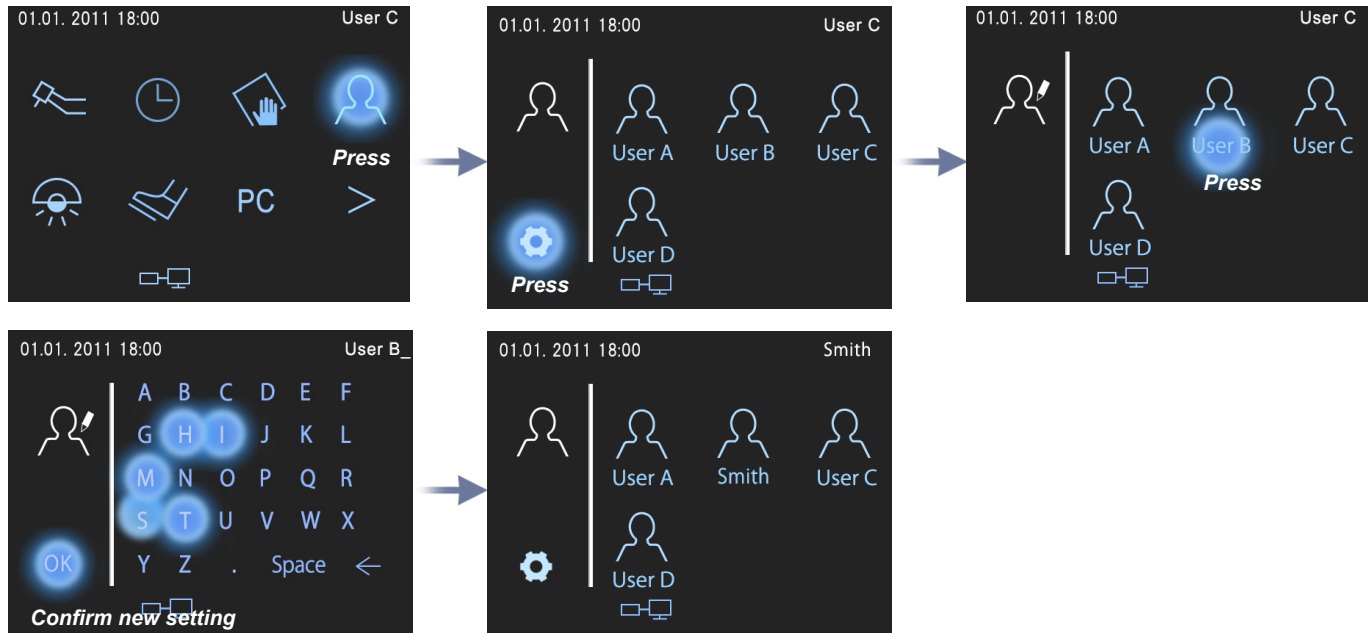

Foot Control Switch Settings

The functions for some of the switches on the foot control can be changed.

* In the System Display, only blue icons are active switches that can be pressed.

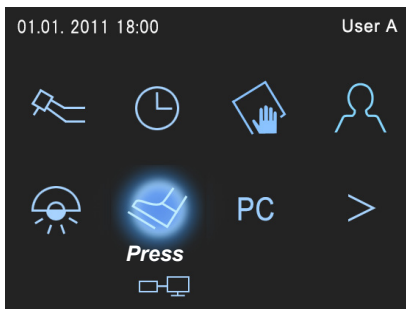

Press the icon for additional settings.

Press the switch for which you want to change functions.

Icon List (1)

Manual Positioning Switches

Auto Position Switches

Instrument Light

Instrument Spray

Micromotor Memory and Scaler Power

Icon List (2)

Micromotor Forward / Reverse Rotation Switch

Chair Speed Switch

Motorized Headrest (Option)

Vacuum and Saliva Ejector Switch

Operating Light Sensor On/Off Switch

Operating Light

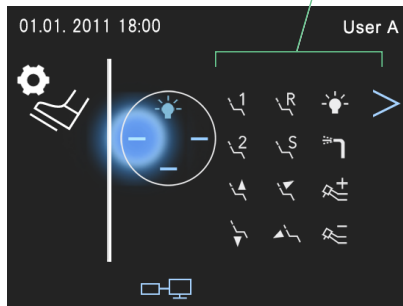

Press one of the icon symbols.

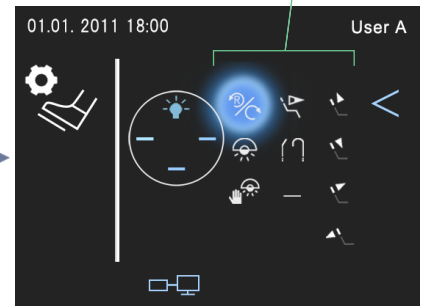

Press one of the blue icons in the list (1 and 2) to select it as the new function for the switch.



Press OK.

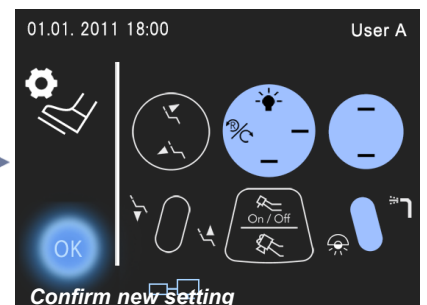

Confirm that the change you wanted has been made and then click OK.

⚠ Auto Position Switches, Micromotor Forward / Reverse Rotation Switch, and Chair Speed Switch must be held down for a while before the chair starts to move.

PC Controls (Option)

The i-Dixel application can be navigated with the mouse-like cursor control on the Soaric operation panel or with the foot control as long as the i-Dixel computer has the MID (Soaric transmission) driver installed and is connected to the Soaric.

ⓘ To use the mouse-like cursor control on the Soaric operation panel or the foot control to navigate the i-Dixel application, first start up the i-Dixel application ; then turn on the Soaric and press the PC button on the Home Page for the System Display.

* Also refer to the instruction manuals for the i-Dixel application.

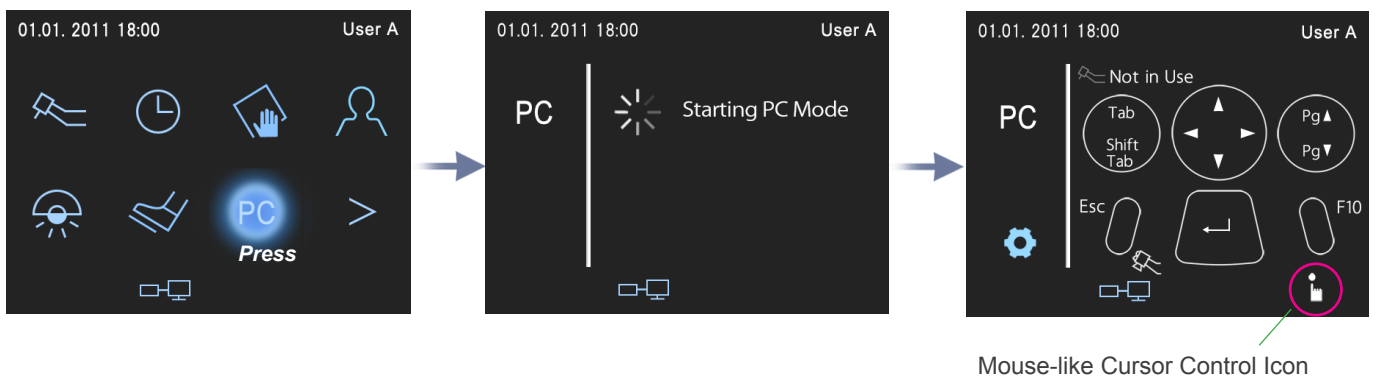

■ The mouse-like cursor control on the Soaric operation panel

When the Soaric's PC button is pressed, the mouse-like cursor control icon will appear in the bottom part of the System Display. The mouse-like cursor control can be used like a mouse while the icon is displaying.

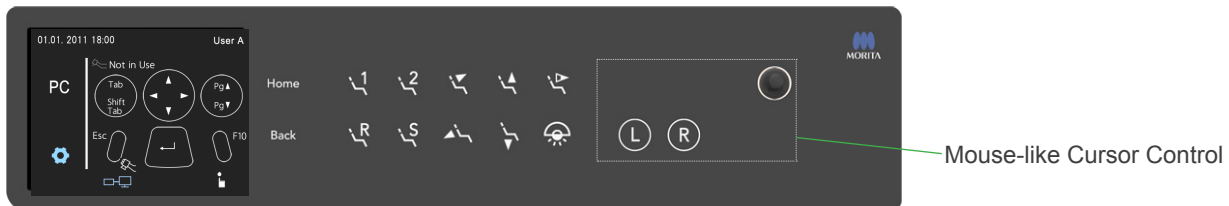

The L and R buttons are the same as the left and right buttons on a mouse and the joystick can be used to move the cursor.

PC Controls (Option)

■ Foot Control

The switches and pedal on the foot control can be used like keys on a keyboard as shown below.

ⓘ A conventional keyboard can also be connected.

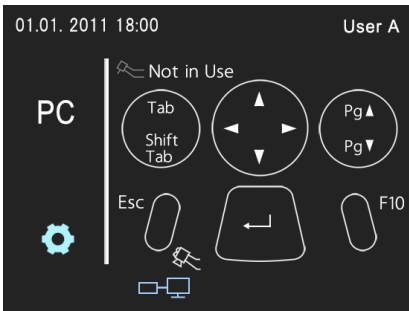

You cannot press the icons on this screen to navigate the computer application.

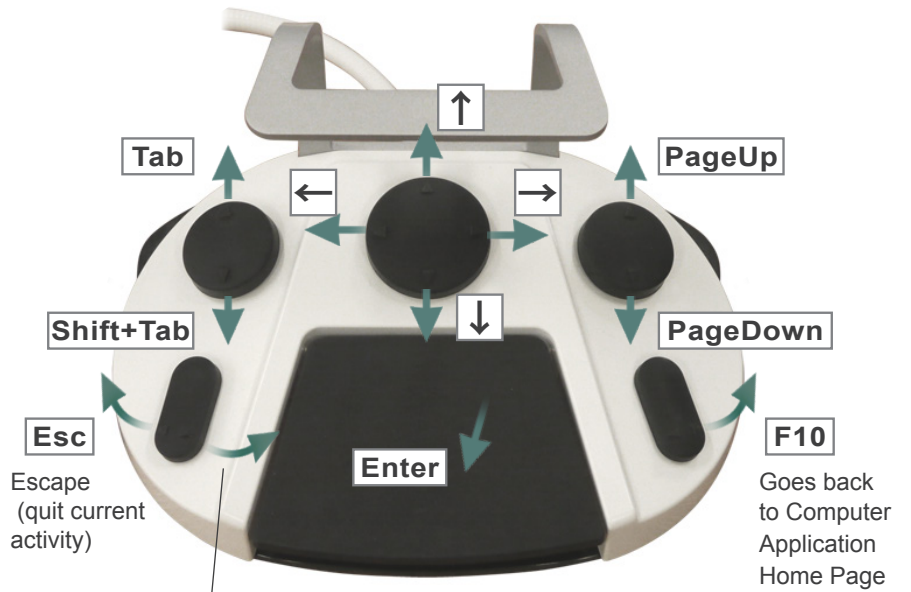

* Make a still image with the Penviewer (option).

- ⓘ Selected button is framed by yellow dotted line.
- ⓘ Yellow dotted line frame appears only in i-Dixel computer is connected to the Soaric and computer network.

- ⓘ Selected button is framed by yellow dotted line.
- ⓘ Some items cannot be selected using the Page Up and Page Down switches. If so, use the joystick on the operation panel instead.

PC Controls (Option)

Examples

<Select and display an image in the 2D Viewer.>

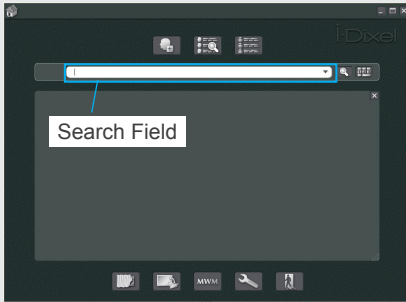

1. Display the patient list.

- ① Use the Tab or Shift-Tab switch to move the cursor to the Search Field.
- ② Press the pedal (Enter) to display the patient list.

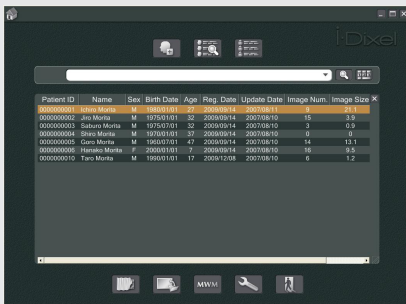

2. Select a Patient.

- ① Use the up or down arrow to select a patient.
- ② Press the pedal (Enter) to display the image list.

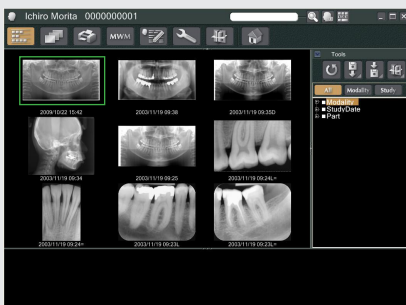

3. Select an image and display it with the 2D Viewer.

- ① Press the Page Up or Page Down switch until a green frame appears around an image.
- ② Use the arrows (up, down, right or left) to move the green frame and select the desired image.
- ③ Press the pedal (Enter) to display the image in the 2D Viewer.

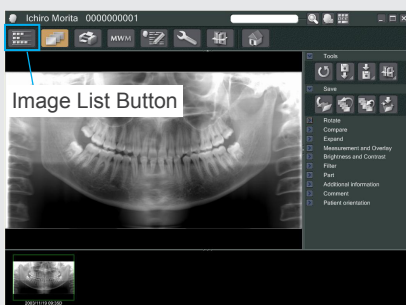

4. Go Back to the Image List.

- ① Select the Image List Button.
- ② [Press the pedal (Enter) to go back to the Image List.

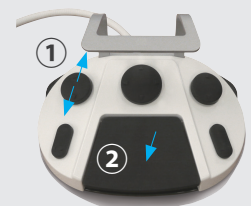

Set Calendar

Set the current date and time that appear in the top left of the system display.

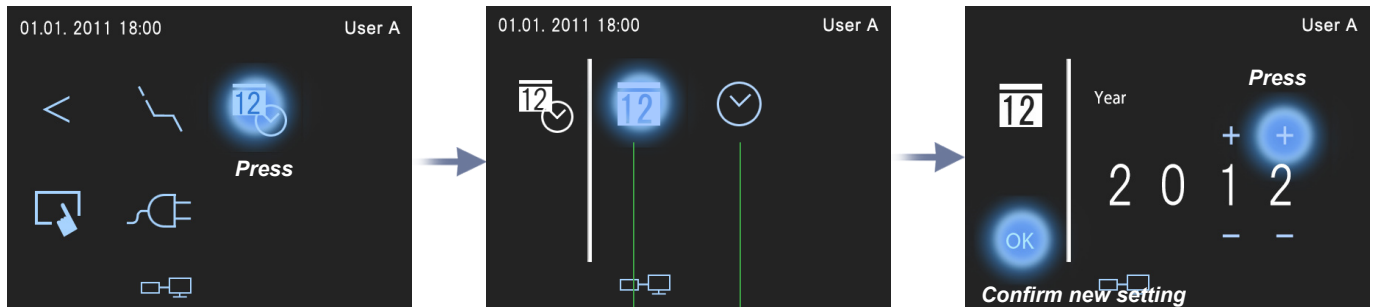

Set the year.

Then press "OK" to shift setting to the month and day.

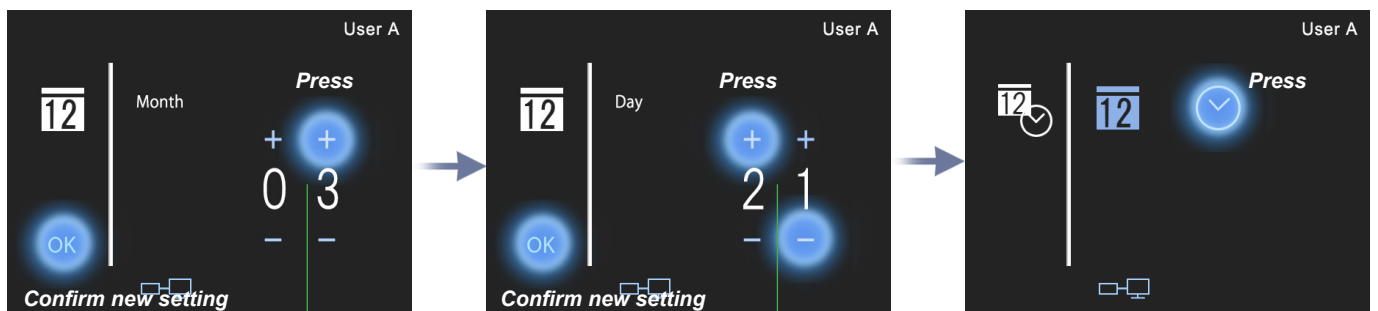

Set the month and day.

Month

Day

Set the time.

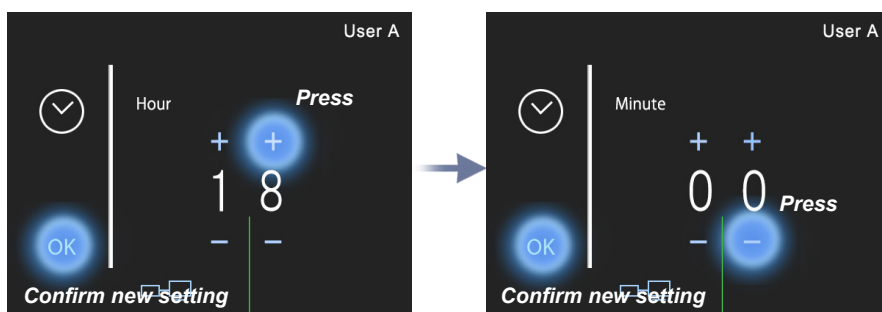

Hour

Minute

Monitor Settings (brightness etc.) (Option)

Adjust the monitor brightness

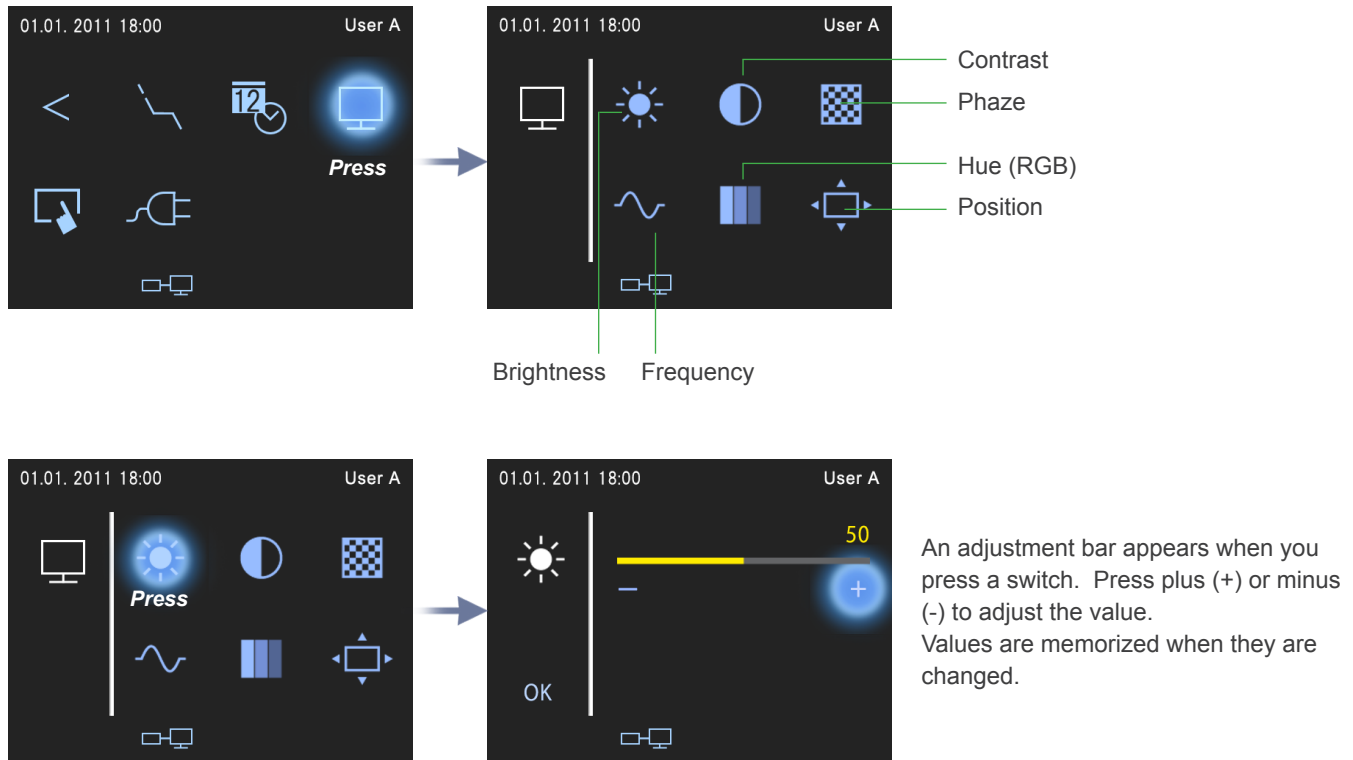

* The computer monitor can be adjusted only if it is set for SXGA (1280 × 1024) mode. Only the monitor brightness can be adjusted if it is set for VGA (640 × 480), SVGA (800 × 600), or XGA (1024 × 768). Also the computer monitor will temporarily go black if it is set for any mode other than SXGA, VGA, SVGA, or XGA. ^(*)

* The frequency setting for the monitor can be 60 or 75 Hz. If the setting is changed, all monitor settings except for brightness will go back to their default values.

* Color depends somewhat on monitor. Adjust the Hue (RGB) to your taste.

^(*) When the computer monitor turns into blackout after you accidentally adjusted other than monitor brightness setting, then cycle the main switch to recover.

When the monitor is switching over to the microscope image. (Option)

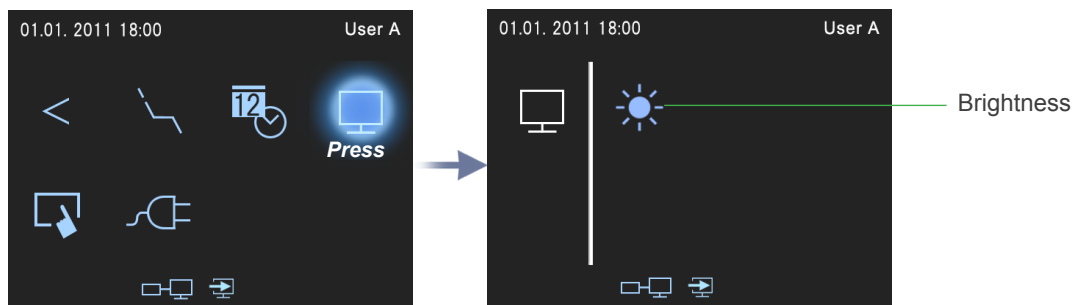

Only the monitor brightness can be adjusted. The other adjustments of the monitor can be performed by the microscope.

Monitor Settings (brightness etc.) (Option)

■ Brightness

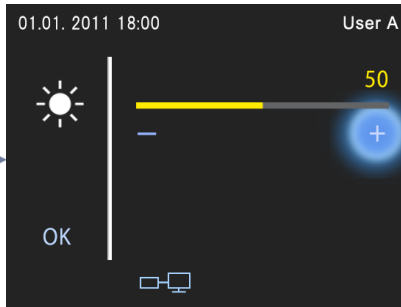
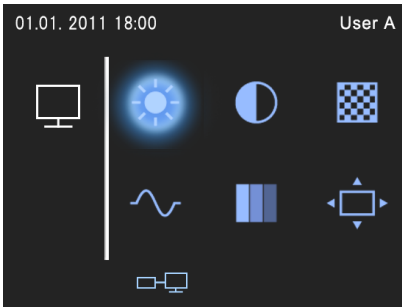

Press plus (+) for brighter or minus (-) for dimmer.

■ Contrast

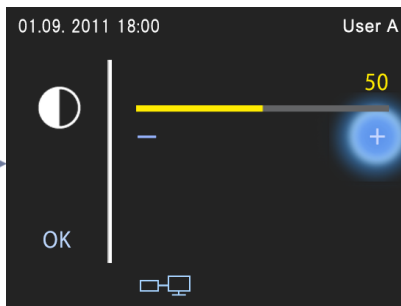

Press plus (+) for more contrast or minus (-) for less contrast.

■ Phase

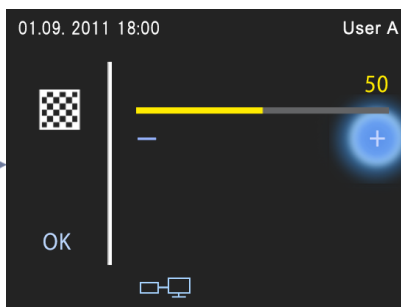
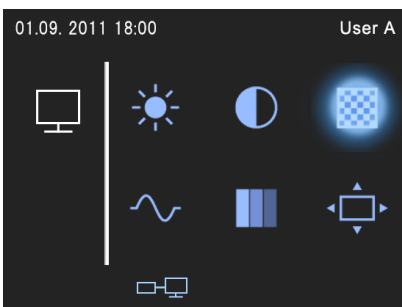

Adjust the phase if the display lacks sharpness or letters appear fuzzy. Press plus (+) or minus (-) to adjust.

■ Frequency

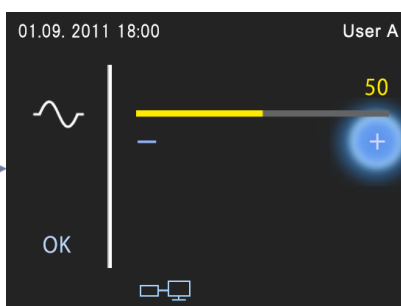

Adjust the frequency if letters flicker horizontally or if colors are not correctly aligned. Press plus (+) or minus (-) to eliminate interference.

Monitor Settings (brightness etc.) (Option)

Hue (RGB)

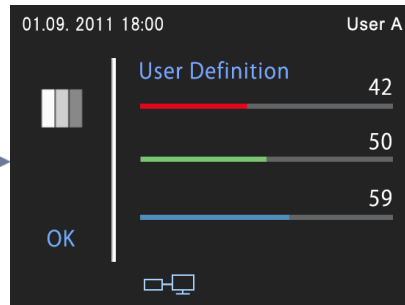
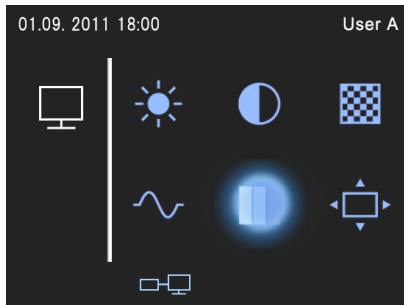

Select and adjust any of the color bars. Press plus (+) for darker or minus (-) for lighter.

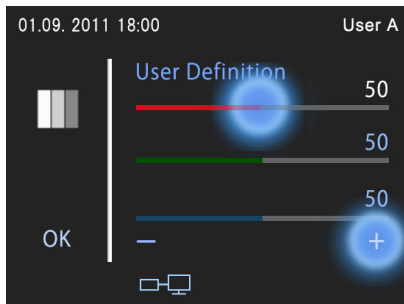

The red bar brightens up when selected to show that it can now be adjusted.

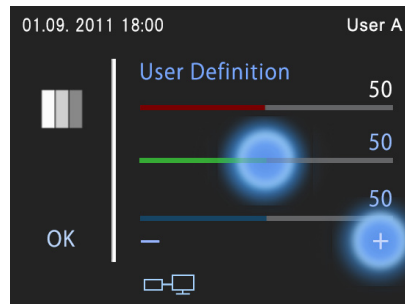

The green bar brightens up when selected to show that it can now be adjusted.

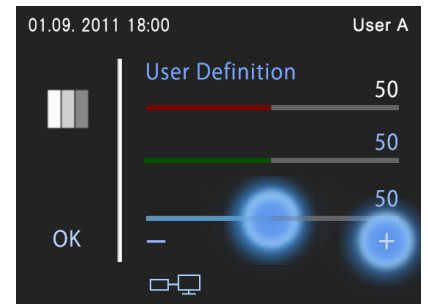

The blue bar brightens up when selected to show that it can now be adjusted.

Position

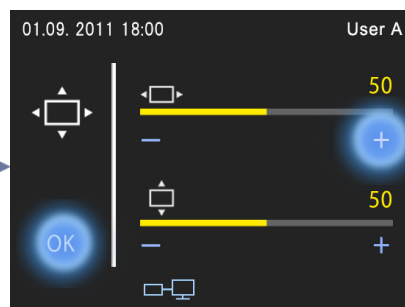

Adjust the position vertically or horizontally. For horizontal adjustment, press plus (+) to move right or minus (-) to move left. For vertical adjustment, press plus (+) to move up or minus (-) to move down.

System Display Settings

Adjust Beep Volume



Auto Power Off, Spray Water Temperature Settings

Set Time Lapse for Auto Power Off

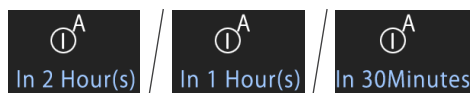
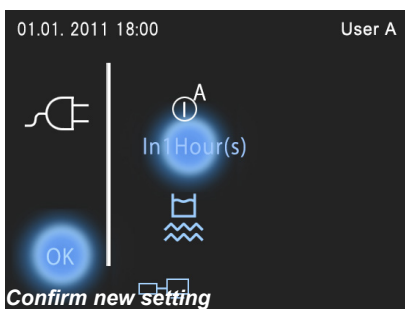
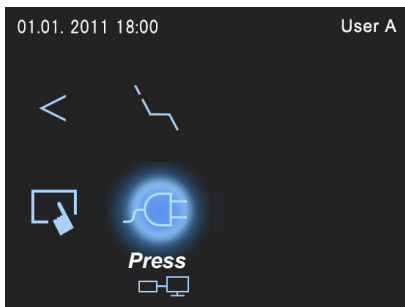

Auto Power Off, Spray Water Temperature Settings

■ Spray Water Temperature Setting

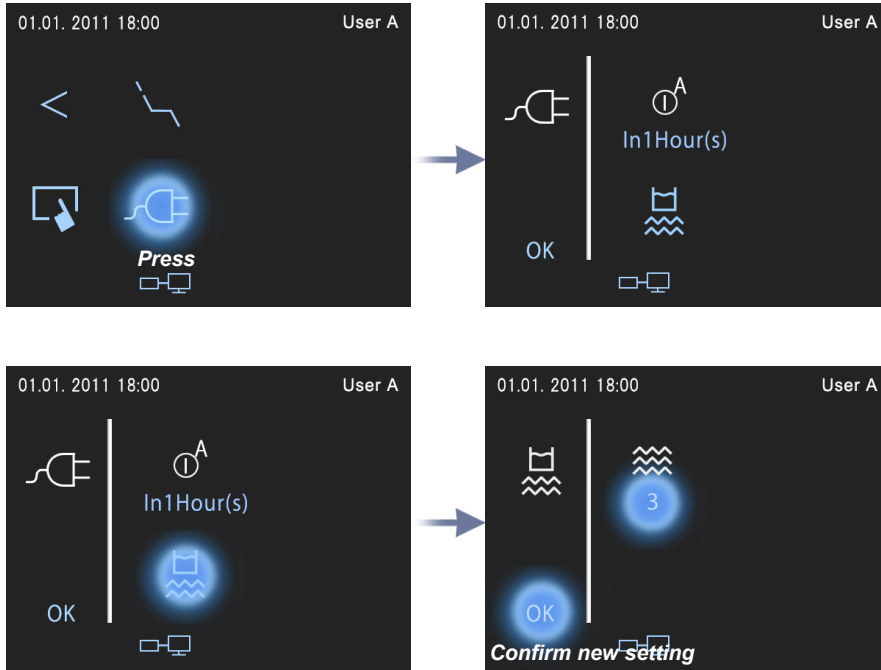

System Display Overlay in Monitor

The System Display can be enlarged and shown in the computer monitor.
You can adjust its size and display it on top of the i-Dixel application display.

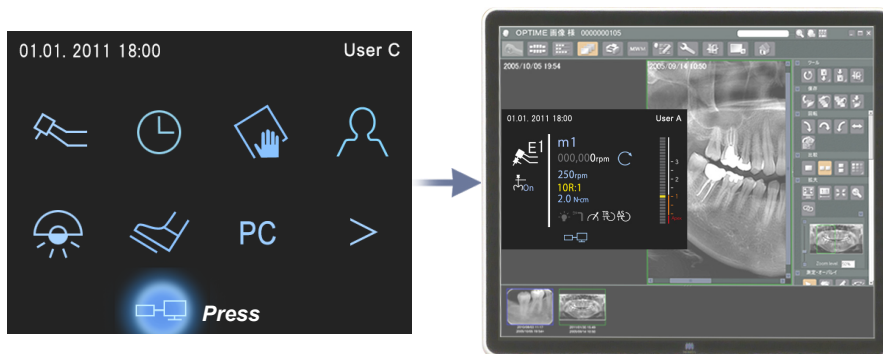

Press the switch to enlarge and show the system display in the computer monitor.
Press the switch again to quit.

Hold down the switch for about 3 seconds to change the window position and size in the order shown below.

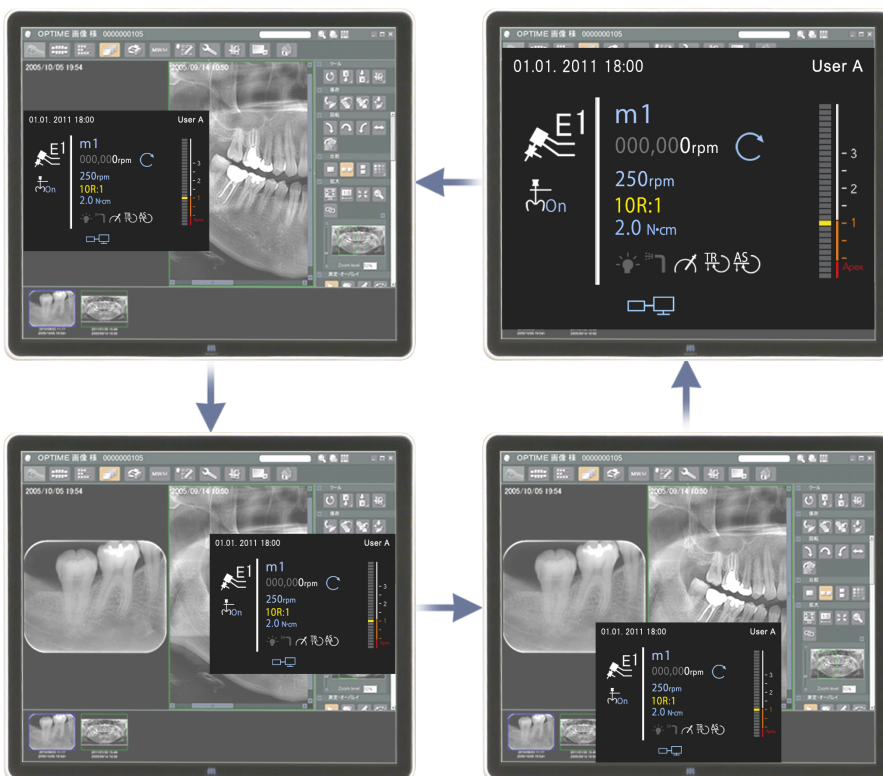

* The system display will appear on top of the application display in the monitor only if the computer is set to use the SXGA (1280 × 1024) mode.

For other display modes such as VGA (640 × 480), SVGA (800 × 600), and XGA (1024 × 768) where the computer only uses part of the monitor screen, the system display can appear in the computer monitor, but it will completely replace the previous monitor display.

(3) After Use

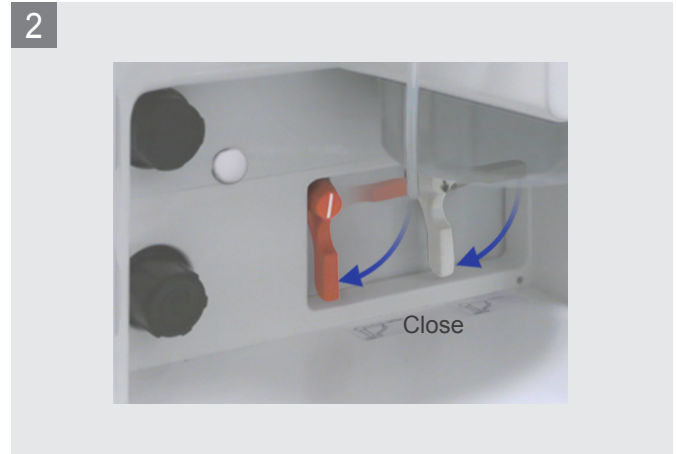
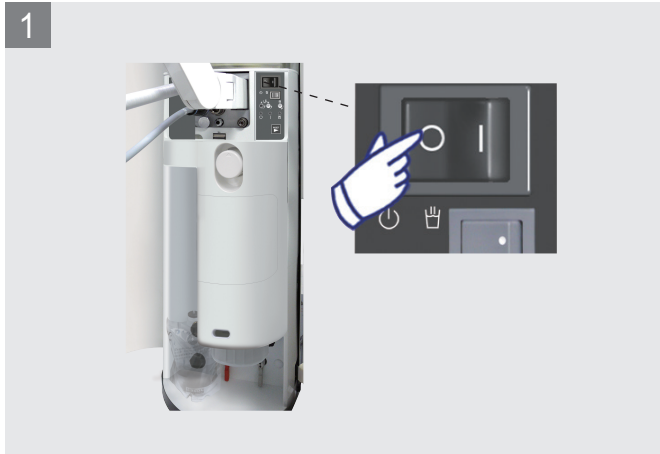

Do not fail to turn off the main switch and close the main air and water valves after each day's use.



- ⚠ In very cold weather the water in the lines could freeze and burst the lines.
To prevent this, expel the water from the lines with the three-way syringes, air turbines, micromotor, and scaler after turning off the main switch and closing the main water and air valves.

⚠ WARNING

- Lower the chair as far as it goes and turn off the main switch after each use to avoid the risk of fires or burns due to overheating as well as water leakage.
- Close the main water valve after each use to avoid the risk of water leakage.

Sterilization, Replacement Parts, and Storage

(1) Sterilization

Autoclavable Components and Instruments

Recommended: 135° C (275° F) for at least 5 minutes inside a sterilization pouch.
Minimum drying time after sterilization: 10 or 20 minutes, depending on the item.

- Air Turbine Handpieces^{*1}
- Micromotor Attachments^{*1}
- Micromotor Motor Cover^{*1}
- Threeway Syringe (nozzle, case and cap) (→ see next page)
- Vacuum Syringe (syringe body, adaptor and vacuum tip)
- Ultra Sonic Scaler (Handpiece and Tip)^{*1*3}
- Waste Cup Holder
- Medicinal Vial Holder
- Tray Handle (→ next page)
- Tray Sheet (Roll sheet up for autoclaving)^{*2}
- Instrument Holders^{*2} (→ see page 94)
- Operating Light Handles^{*1*2}
- Implant Motor^{*4}

^{*1}: Refer to separate user manuals.

^{*2}: Minimum drying time after sterilization: 20 minutes.

^{*3}: For scalers made by other companys, refer to the user manual provided by the manufacturer.

^{*4}: For implant motors made by other companys, refer to the user manual provided by the manufacturer.

- ⚠ Autoclaving and drying temperatures must never exceed 135° C/ 275° F.
- ⚠ Clean everything thoroughly before autoclaving. Any chemical or foreign debris left on instruments could cause them to malfunction or could cause discoloration.
- ⚠ Oils and chemicals can deform or discolor plastics and resins during autoclaving; instruments and utensils which are used with chemicals or oils should be autoclaved separately from others. Plastic items can also be deformed by the heat; avoid this by putting them on a piece of gauze and take care that they do not directly contact the tray or other metals parts of the autoclave.



After Use



Sterilization

WARNING

- To prevent the spread of serious, life-threatening infections such as HIV and hepatitis B, the above components must be autoclaved after the completion of each patient.

CAUTION

- Do not sterilize in any way other than autoclave.
- The instrument is extremely hot immediately after autoclaving; do not touch it for at least 10 minutes.

Autoclavable Components and Instruments

■ Threeway Syringe

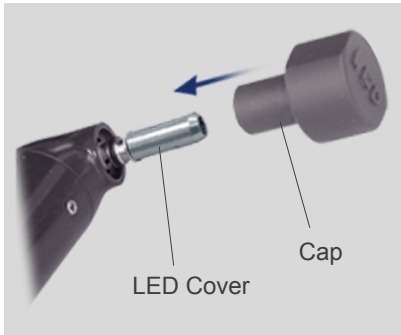

Put the cap on the LED cover before autoclaving.



■ Tray Handle



Pull it out to remove.

■ Instrument Holders

Assistant Instrument Holder

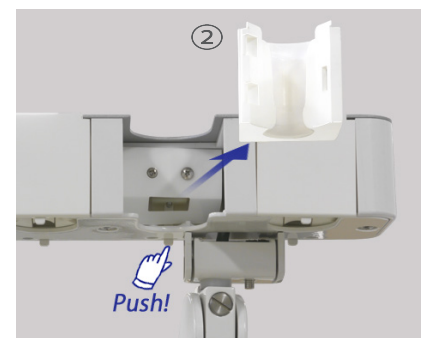
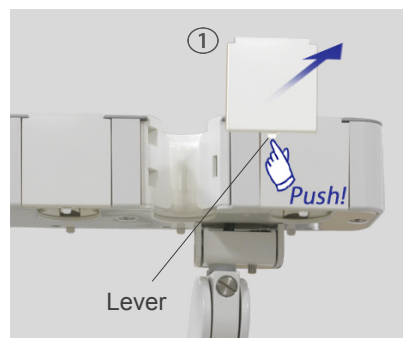
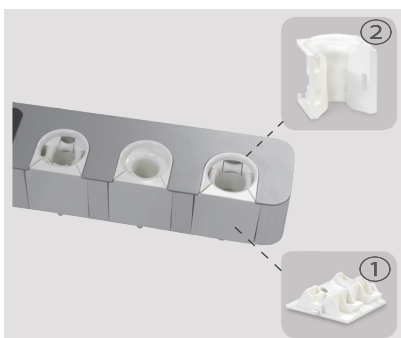

Remove it by pulling while pressing the lever.

ⓘ To attach it, push it in securely until it clicks into place.

⚠ CAUTION

Autoclaving can degrade the LED; put the cap on the LED cover before autoclaving.

Autoclavable Components and Instruments

■ Instrument Holders

Floor-mounted Tray



How to remove

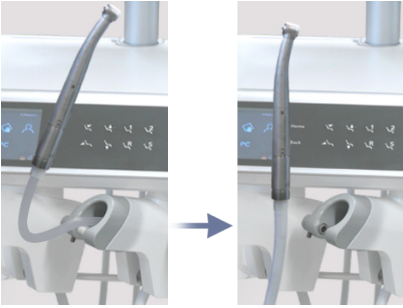

Open the tube holding lever and remove the main tube.

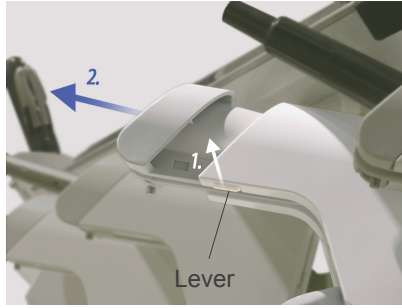

Pull it out while sliding the lever.

How to attach

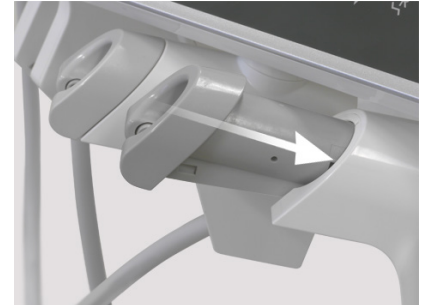

Attach it by reversing the procedure to remove it.

Components Disinfected by Wiping with Ethanol

Clean outside surfaces including the seat only with Ethanol for Disinfection (Ethanol 70 to 80 vol%)



- Headrest, Seat, Backrest, Leg Support
- Headrest Cover
- Main Tubes
- Base-mounted Tray
- Assistant Auxiliary Tray
- Large Tray
- Smaller size Tray
- Front Cover for Operating Light (refer to separate user's manual)
- Tray Switch Panel
- Housing and Enamel Surfaces
- Monitor (option)
- Bottle for Flushing System
- Foot control

- ⓘ Clean outside surfaces including the seat only with Ethanol for Disinfection (Ethanol 70 to 80 vol%) or a neutral detergent. Alkaline and acidic cleaners or any of the chemicals listed below can cause cracking, discoloration, and other damage. Do not use aldehydes, cresols, hypochlorite, quaternary ammonium salt etc. (Check contents charts and cautionary notes on containers.)
- ⓘ Use only Ethanol for Disinfection (Ethanol 70 to 80 vol%) to disinfect the instrument. And use Ethanol for Disinfection (Ethanol 70 to 80 vol%) to immediately wipe off any chemicals that are accidentally spilled on the seat etc.
- ⓘ Do not directly spray Ethanol for Disinfection (Ethanol 70 to 80 vol%), neutral detergent or water on the unit. Make sure no liquid seeps inside; this could cause mechanical or other malfunctions.
- ⓘ Do not use ozone water to clean the unit or its drain and vacuum lines. Ozone water could cause rusting inside the lines and other damage to the unit.
- ⓘ Do not disinfect the clinic with ozone gas or ultraviolet light. This could damage plastic and rubber components.
- ⓘ When cleaning the floor around the chair, take care not to get water or solutions used for floor waxing on the foot control.
- ⓘ Do not press down on the operation panel too hard when cleaning it.

WARNING

- Turn off the main switch before disinfecting components and surfaces with Ethanol for Disinfection (Ethanol 70 vol% to 80 vol%) to avoid the risk of electric shocks, burns, or accidentally pressing any switches that could move the chair unit unexpectedly and result in injuring the patient.

Regular Maintenance

* Perform maintenance at the specified intervals or more frequently if necessary.

* Always wear surgical gloves when performing maintenance.

■ Everyday

Between Patients

- Vacuum System Rinsing (tubes and tank)..... 99

After Use

- Clean vacuum filter..... 102
- Clean basin..... 103
- Vacuum System and Water Line Decontamination with the cleanser bottle system..... 104

■ Once a Week

- Vacuum System and Water Line Decontamination with water decontamination system..... 112
- Clean basin..... 118

■ Once a Month

- Clean flushing device..... 119
- Clean basin drain filter and trap..... 120
- Clean air turbine oil collection case..... 121
- Clean spittoon valve..... 121

■ Every Six Months

- Clean vacuum tank..... 122

■ Once a Year

- Replace bacteria filters and cases..... 124

■ Whenever the water or vacuum lines might be contaminated

- Vacuum System and Water Line Rinsing..... 126
- Vacuum System Decontamination..... 129

Regular Maintenance: Maintenance Display

■ Maintenance Display

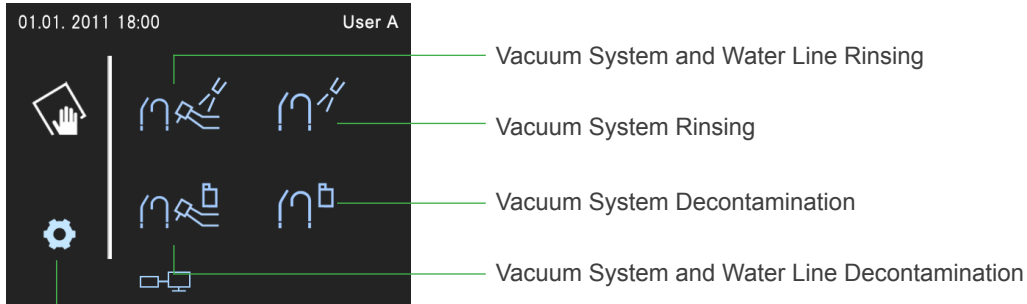

Press this to select either cleanser or water.



See page 78 for automatic tank rinsing.

ⓘ Select "Cleanser" for Water Decontamination System or Cleanser Bottle System and for Vacuum System Decontamination.

Regular Maintenance: Maintenance Display

■ Maintenance Procedure Display

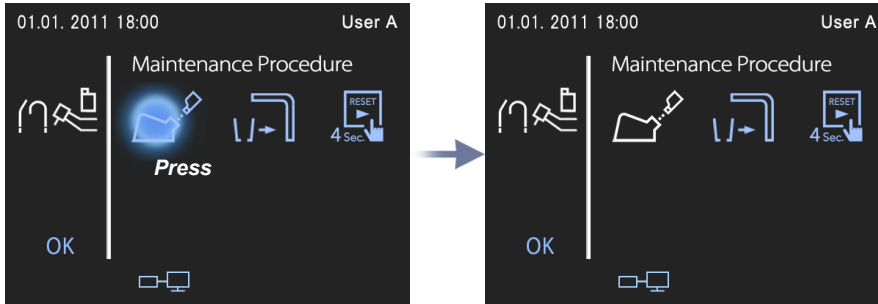

After pressing the button for one of the maintenance procedures, the steps for that procedure will be displayed. After you complete each step, press the icon for that step. It will change from **blue** to **white**. This will help you remember which steps you have completed.

■ Display during Maintenance

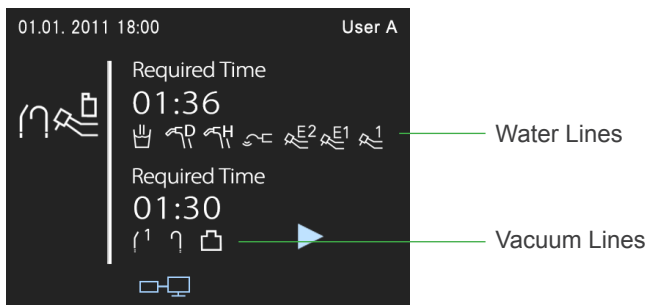

The icons for the various instruments change color.

- Gray: The instrument tube is still in its holder.
- White: The instrument has been taken out of its holder.
- Yellow: Cleanser is in the water or vacuum line.
- Green: The cleanser has been flushed out.

Regular Maintenance: Between Patients

■ Vacuum System Rinsing

Rinse the vacuum system tubes and tank.
Debris in the vacuum tubes will weaken the vacuum.

1

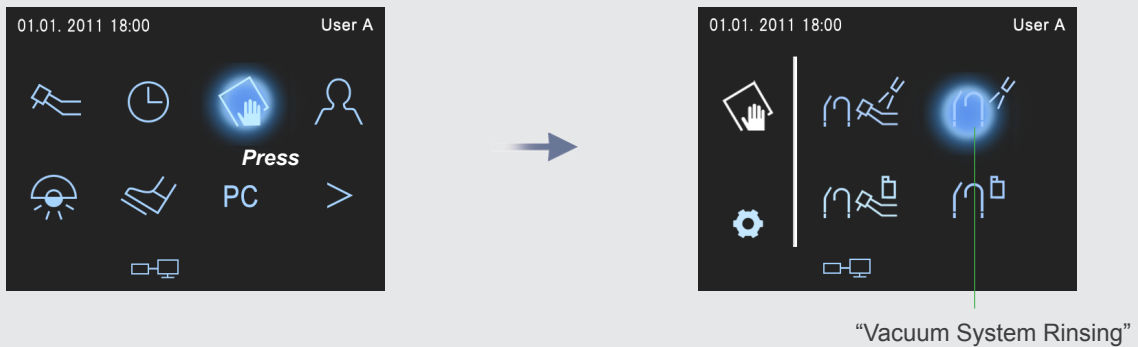

Press the maintenance button. Then press the vacuum system rinsing button.

2

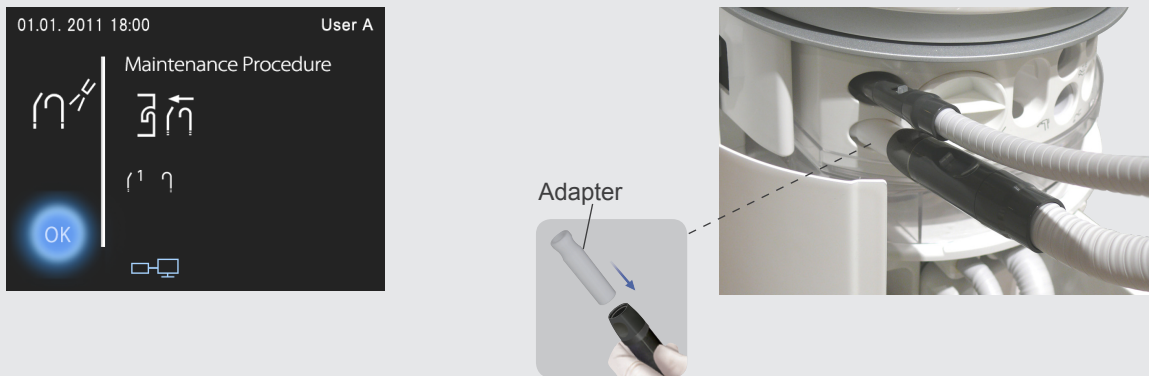

Take out the vacuum syringe. Connect the rinsing adapter provided to the adapter on the end of the vacuum syringe. Put the vacuum syringe into the flushing device.

Take off the ejector tip and put the ejector tube into the flushing device.

Press OK.

* Only the tubes put into the flushing device will be rinsed. If no tubes are put in, then only the vacuum tank will be rinsed.

Regular Maintenance: Between Patients

3



Press the Start icon. The clock will start its count down to show how long before the procedure has been completed.
* If you wish to stop the procedure, refer to the instructions for this on the next page.

4

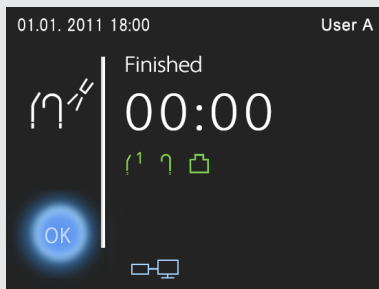

Press OK when the procedure has been completed.

5



Put the instruments back in their holders and close the maintenance cover. Then press OK.

Regular Maintenance: Between Patients

Stop Maintenance Procedure

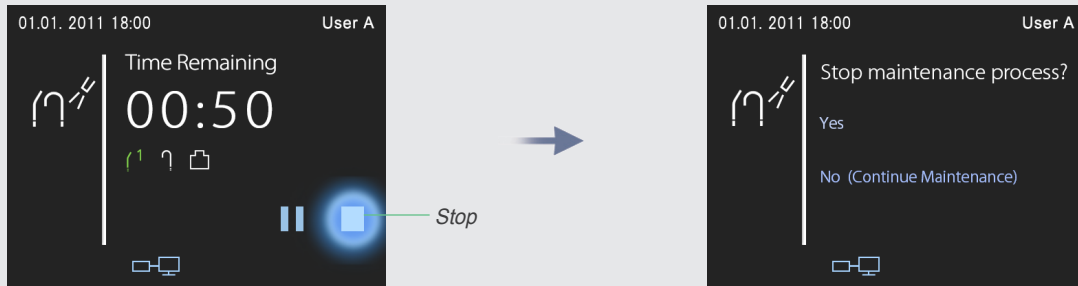

The display shown above appears if you stop the procedure.
Press Yes or No and then press OK to go to the Home Page.

Regular Maintenance: After Use

■ Vacuum Filter

1

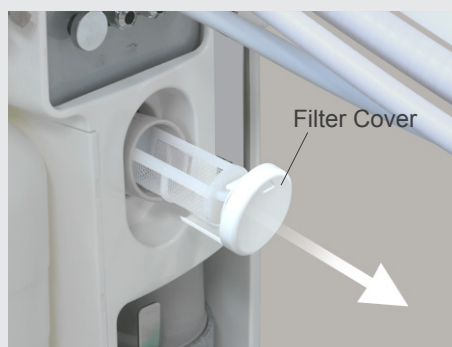
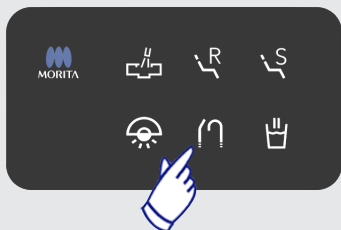

Press the vacuum switch on the assistant side to remove all the water left in the filter. Wait 5 seconds and then press the switch again to turn the vacuum off. Finally turn off the main switch. Open the maintenance cover and pull off the filter cover.



ⓘ Have a towel or something ready to catch any contaminated water that drips from the filter or any debris that falls out.

2

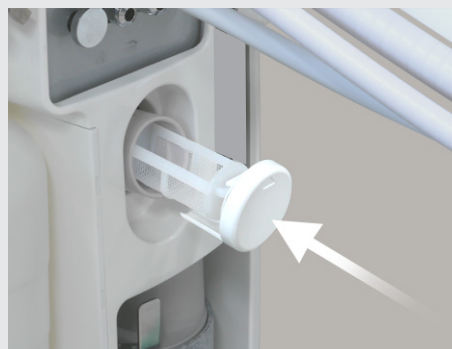
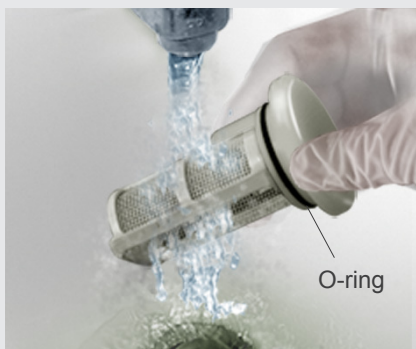

Wash the filter in running water. Push the filter all the way back into its original position.

- ⓘ Coat the O-ring with Vaseline or some similar substance before putting the filter back.
- ⓘ The vacuum will lose power or leak if the filter cover is not fit in as tightly as possible.

! WARNING

- Turn off the main switch while cleaning the vacuum filter to avoid the risk of electric shocks or burns.

Regular Maintenance: After Use



Basin

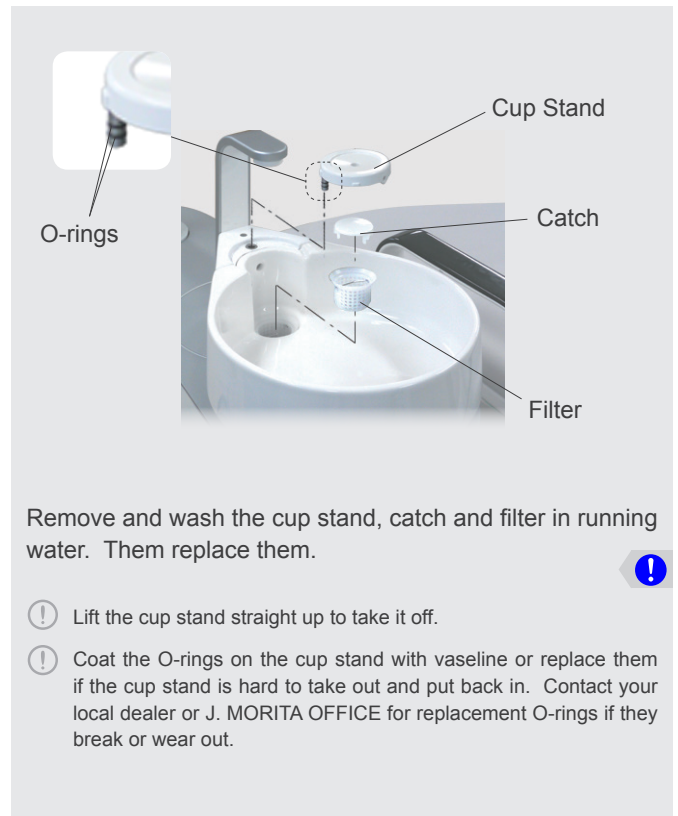
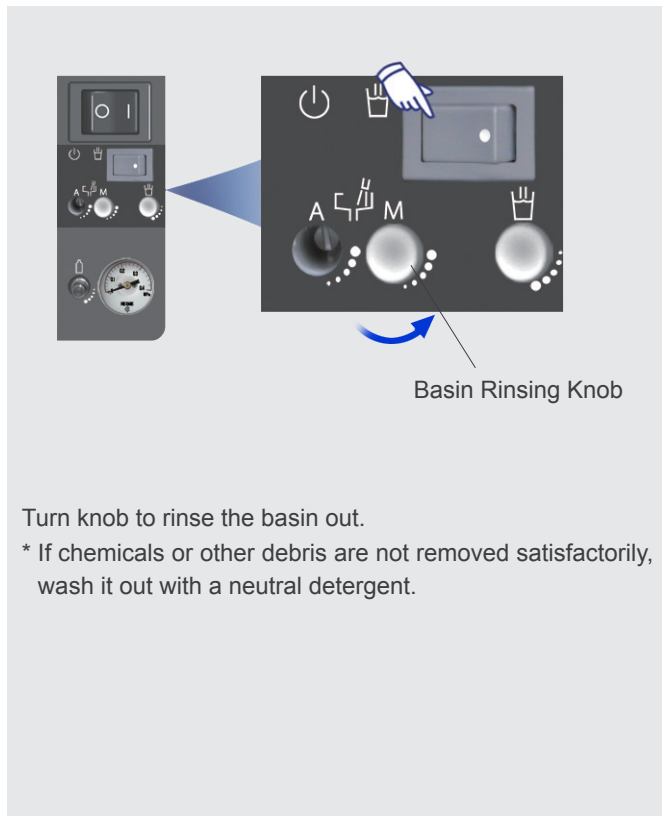

⚠ Do not grab or hold onto the water spout; this could damage it and result in water leakage or other malfunctions.



⚠ If you run too much water to the basin at once, water may spill from the overflow hole. If water is spilled, wipe it off thoroughly from the basin stand and basin unit covers.

* The overflow hole is for discharging the drain water from the unit and preventing the drain water from mixing with the clean water supply line when the drainage line is clogged.

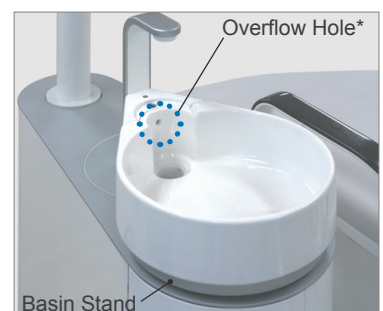

! WARNING

- Turn off the main switch before removing the basin bowl and cup stand to avoid the risk of electric shocks or fires. Be sure to reinstall the basin bowl and cup stand before turning the unit back on.

Regular Maintenance: After Use



■ Cleanser Bottle System

The Water Bottle System uses the bottle to supply disinfectant to water lines. This system decontaminates the water and vacuum lines. Disinfectant is left in the lines when the unit is not being used to keep the lines clean and antiseptic. This should be the last thing you do at the end of the day.

1



Grip this part firmly to swivel the instrument holder.

Raise the backrest and move the tray towards the backrest.
Swivel the instrument holders in the direction shown by the arrows in the photo.

2

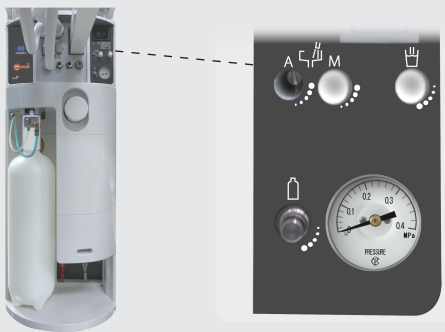

Make sure the pressure is 0.0 MPa.

WARNING

- Do not fail to flush the cleanser out of the lines before using the unit for treatment. Never use the unit before flushing the cleanser out.

Regular Maintenance: After Use



3

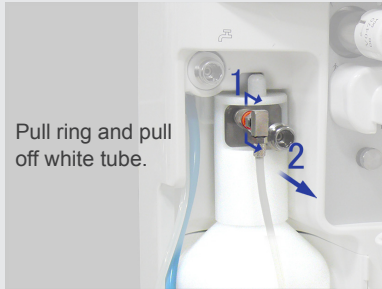

Pull ring and pull off white tube.

Take the white air tube off the top of the bottle.

4

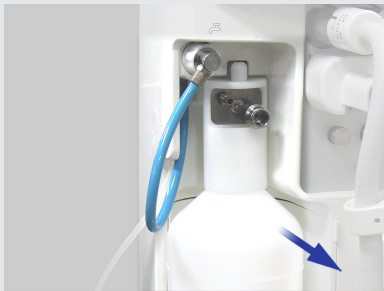

Pull the bottle out and take off the cap.

* Empty out any cleanser left in it.

Put 50 ml of cleanser in the bottle and then fill it up with tap water. This will make a solution concentration of 500 ppm.

* Refer to the instructions on the original container for the cleanser.



5

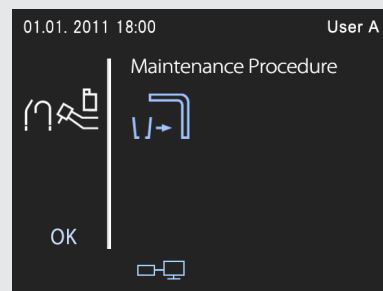
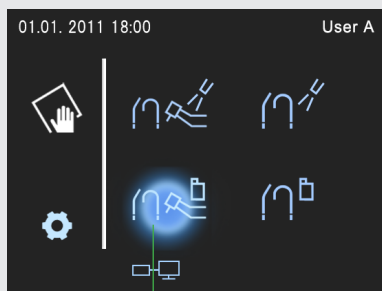

"Vacuum System and Water Line Decontamination"

Press the icon for the Vacuum System and Water Line Decontamination on the System Display.

Perform the steps for the procedure that appear in the display.

CAUTION

- Make sure the cap is on tight. The unit may malfunction if it comes off during use.
- Do not pinch or crimp the air and cleanser tubes that are connected to the cap.
- Make sure the tubes are properly connected.

Regular Maintenance: After Use



6

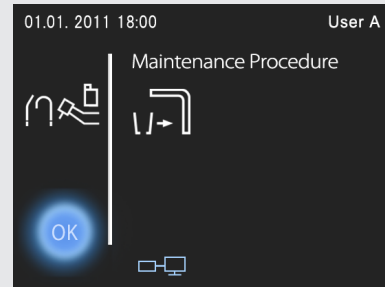

Put a dummy cup on the cup stand and press OK.

7

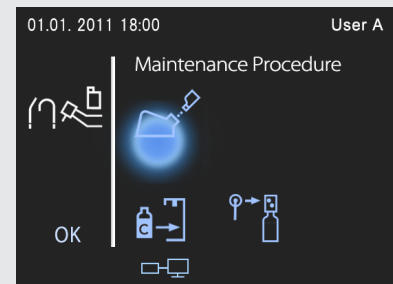

Make a liter of diluted Orotol Plus solution and pour about half in the basin.
* Refer to the separate user manual for the Durr Company's Orotol Plus.

8

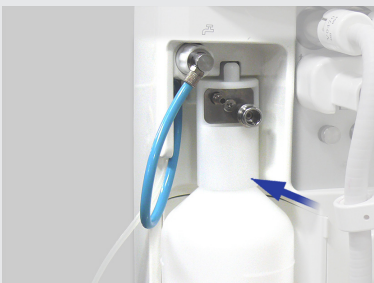

Put the cap back on the bottle and put the bottle back in place.

9

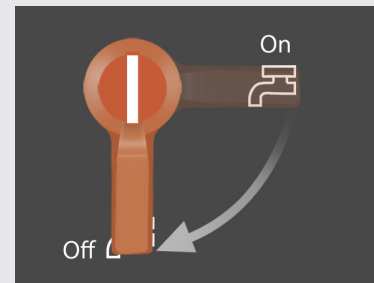

Turn the water valve off.

Regular Maintenance: After Use



10



1. Loosen the lock nut.
2. Take the blue water tube off the main unit.

⚠ Make sure the water valve is closed before taking off the blue water tube. If the tube is taken off or put on while the valve is open, water will leak out from the lock nut.



3. Put the blue water tube on the bottle and fasten it with the lock nut.

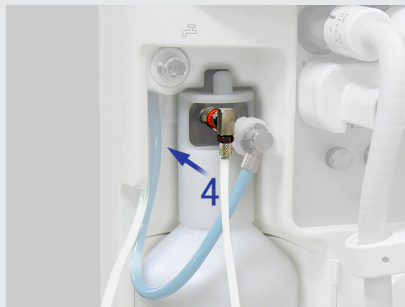

4. Connect the white air tube to its original position.



⚠ If the blue water tube is hard to put on or take off, coat the O-ring on the lock nut with a little vaseline.

11



Press OK.
Perform the next steps of the procedure that appear in the display.

CAUTION

- Make sure the tube is properly and securely connected.

Regular Maintenance: After Use



12

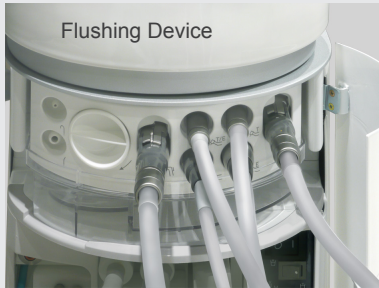

Put the instrument tubes into the flushing device.

[Doctor's instruments]



Threeway Syringe:

Take off the nozzle, put it in the flushing device and fix the water lever in the down position.



E1 or E2 Micromotor:

Take the attachment off the micromotor and put it in the flushing device.



Scaler:

Take the handpiece off its tube and put the tube in the flushing device.



1 or 2 Air Turbine:

Take the handpiece off its tube and put the tube in the flushing device.

[Assistant Instruments]



Threeway Syringe:

Take off the nozzle, put it in the flushing device and fix the water lever in the down position.

- ⓘ If the tubes can't reach the flushing device, reposition the tray so that they do (refer to step 1).
- ⓘ After inserting the instruments into the flushing device, do not move the tray or tubes or bump into them.
- ⓘ Do not take an instrument out of the flushing device after pressing "OK".

13



Put on adapter.



Pull out the tubes for the vacuum and saliva ejector. Take off the vacuum tip and the ejector tip. Put the tubes into the container for the Orotol Plus solution.

Press OK after the tubes have all been put in place

- ⓘ Do not pull out the tubes from the containers of the flushing device and the Orotol Plus solution after you have pressed OK.

Regular Maintenance: After Use



14



Check that the pressure is between 0.18 and 20.0 MPa.

[Adjusting the Pressure]

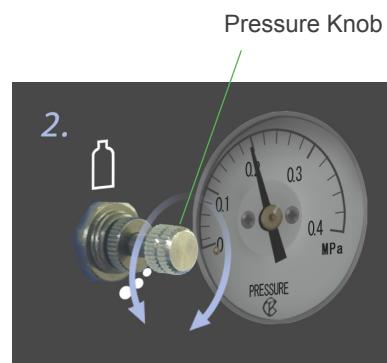
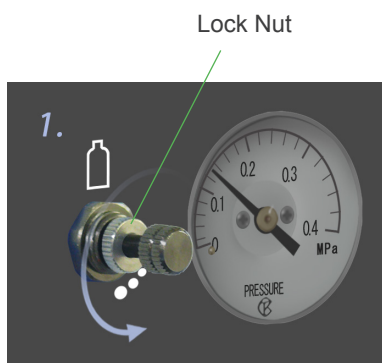

Loosen the lock nut and turn the pressure knob until the pressure gauge reads between 0.18 and 20.0 MPa. Then retighten the lock nut.

15

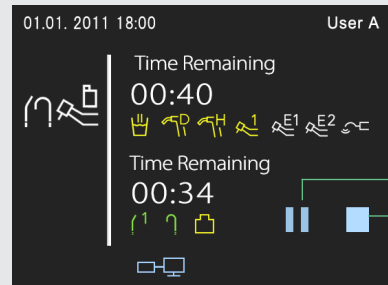
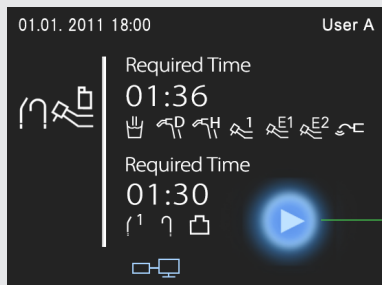

Press the Start icon. The clock will start its count down to show how long before the procedure has been completed.

* If you wish to stop the procedure, refer to the instructions for this on page 111.

⚠ While the procedure is running, check that water is going into the cup and the level of the cleanser in the bottle drops.

Regular Maintenance: After Use



16

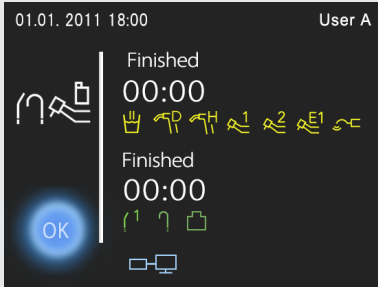

Press OK when the procedure has been completed.

17



Put all the instruments and tubes back in their holders. Press OK.

18

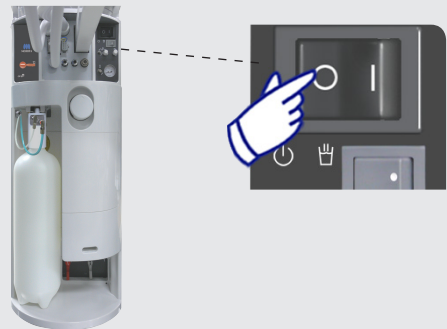
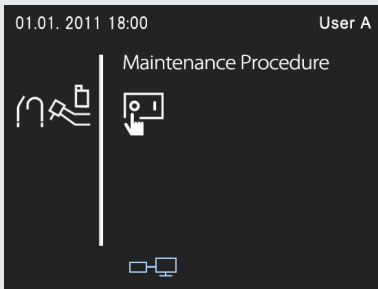

Turn the chair unit off and check that the pressure drops to 0.0 MPa.

19

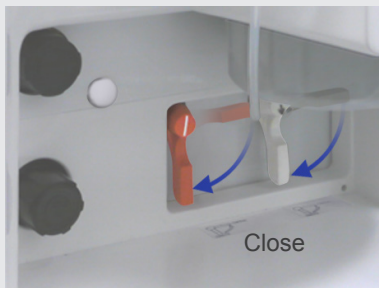

Empty out the bottle and close the main air and water valves.

Leave the cleanser solutions in the water and vacuum lines until the next time you use the unit.

⚠ Do not fail to empty out any cleaning liquid left in the bottle at the water lines have been flushed out. Otherwise, the cleaning fluid could cause mold to grow or pollute the water lines.



Stop Maintenance Procedure

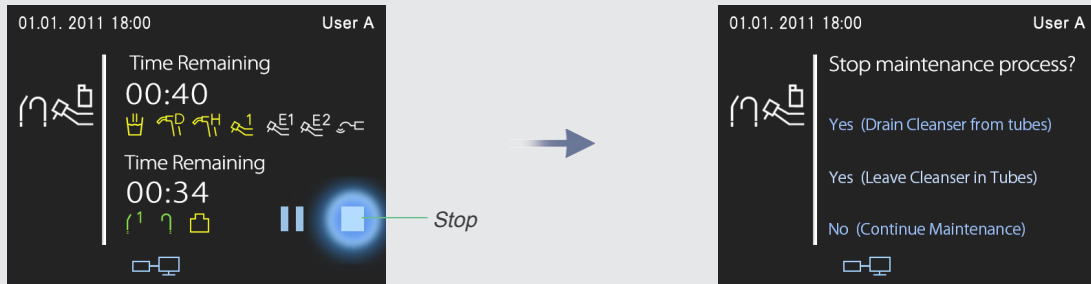

The display shown above appears if you stop the procedure.
Press one of choices.

For “Yes (Leave Cleanser in Tubes)”

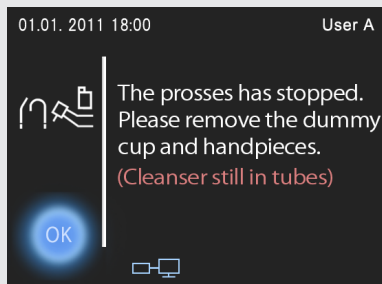

If you press “Yes (Leave Cleanser in Tubes),” follow the instructions that will appear (remove dummy cup and instruments) and then press OK to go to the Home Page.

Do not fail to rinse out the water and vacuum lines before using the unit. See page 21.

Regular Maintenance: Once a Week



Water Decontamination System

* Refer to the separate user manual for METASYS Company's WEK.

The Water Decontamination System decontaminates the water supply and pipes, using disinfectant (hydrogen peroxide). This system is used to supply water-fed equipment and instruments with decontaminated water.

1



Grip this part firmly to swivel the instrument holder.

Raise the backrest and move the tray towards the backrest.
Swivel the instrument holders in the direction shown by the arrows in the photo.

2

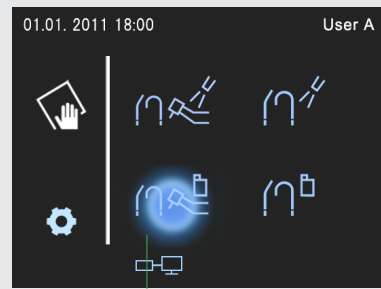
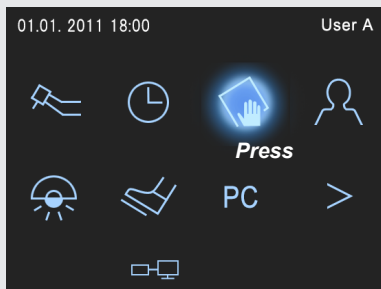

"Vacuum System and Water Line Decontamination"

Press the icon for the Vacuum System and Water Line Decontamination on the System Display.

Regular Maintenance: Once a Week



3



Make a liter of diluted Orotol Plus solution and pour about half in the basin.
* Refer to the separate user manual for the DURR Company's Orotol Plus.

4

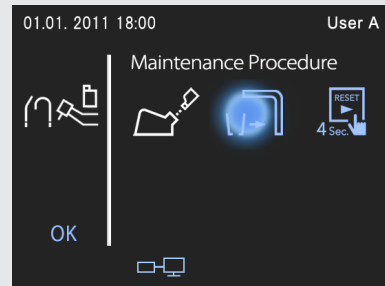

Put a dummy cup on the cup stand.

Regular Maintenance: Once a Week



5

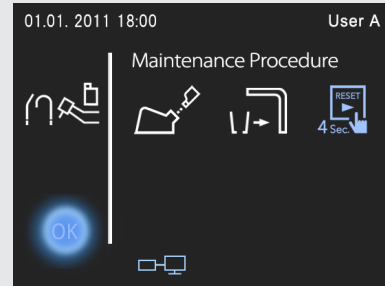
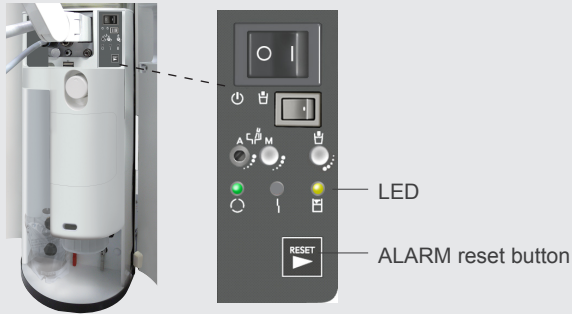

Hold down the Alarm Reset button for about 4 seconds.
Check that the green Ready LED is blinking and that the Disinfectant sensor LED is on.
Press OK.

6

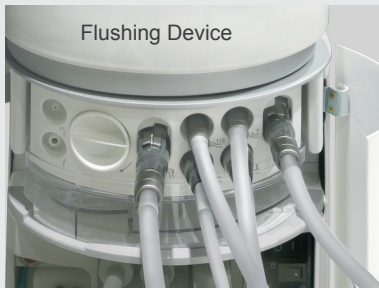

Put the instrument tubes into the flushing device.

[Doctor's instruments]



Threeway Syringe:

Take off the nozzle, put it in the flushing device and fix the water lever in the down position.



E1 or E2 Micromotor:

Take the attachment off the micromotor and put it in the flushing device.



Scaler:

Take the handpiece off its tube and put the tube in the flushing device.



1 or 2 Air Turbine:

Take the handpiece off its tube and put the tube in the flushing device.

[Assistant Instruments]



Threeway Syringe:

Take off the nozzle, put it in the flushing device and fix the water lever in the down position.

⚠ If the tubes can't reach the flushing device, reposition the tray so that they do (refer to step 1).

⚠ After inserting the instruments into the flushing device, do not move the tray or tubes or bump into them.

⚠ Do not take an instrument out of the flushing device after pressing "OK".

Regular Maintenance: Once a Week



7



Put on adapter.



Pull out the tubes for the vacuum and saliva ejector. Take off the vacuum tip and the ejector tip. Put the tubes into the container for the Orotol Plus solution.

Press OK after the tubes have all been put in place

ⓘ Do not pull out the tubes from the containers of the flushing device and the Orotol Plus solution after you have pressed OK.

8

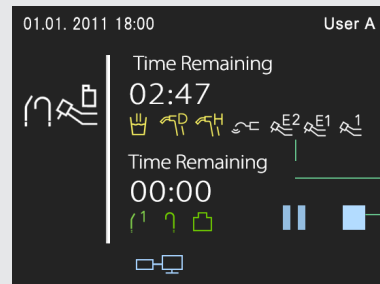
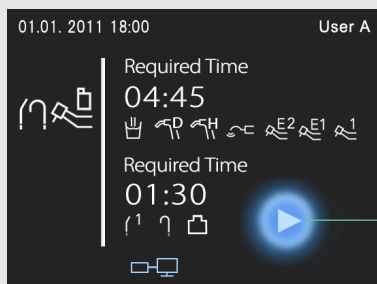

Press the Start icon. The clock will start its count down to show how long before the procedure has been completed.

* If you wish to stop the procedure, refer to the instructions for this on page 117.

ⓘ While the procedure is running, check that water is going into the cup.

Regular Maintenance: Once a Week



9

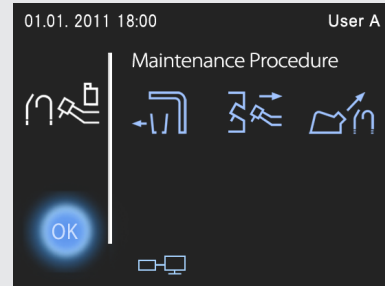
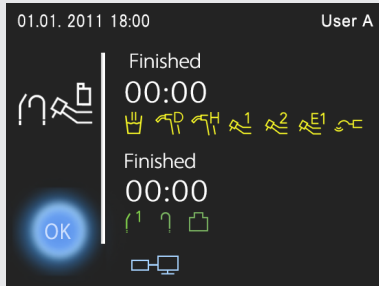

Press OK when the procedure has been completed.

Take off the dummy cup and put all the instruments and tubes back in their holders.

Press OK.

ⓘ Before using the threeway syringe or the motor handpiece, blow air through them to get rid on any water inside the lines.

10

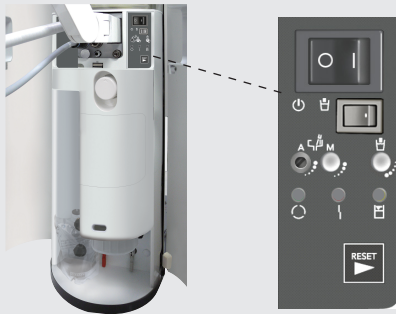

Turn the chair unit off.

11

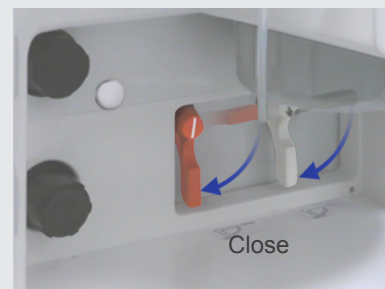

Close the main air and water valves.

Maintenance: Once a Week



Stop Maintenance Procedure

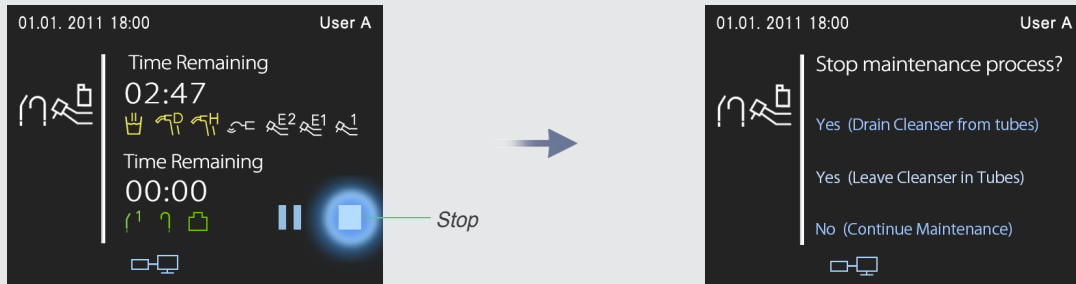

The display shown above appears if you stop the procedure.
Press one of choices.

For “Yes (Leave Cleanser in Tubes),”

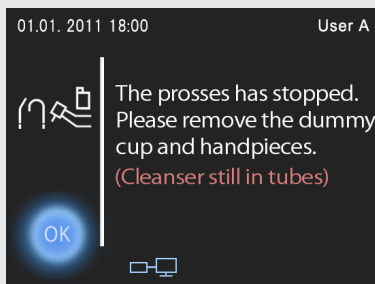

If you press “Yes (Leave Cleanser in Tubes),” follow the instructions that will appear (remove dummy cup and instruments) and then press OK to go to the Home Page.

Do not fail to rinse out the water and vacuum lines before using the unit. See page 126.

Regular Maintenance: Once a Week

■ Basin



Take the basin out and clean it once week.

Turn off the main switch.

Take off the cup stand and then the basin. Wash them in running water.

* Use a neutral detergent to remove chemicals or other debris stuck to it.



- ⓘ To remove the basin, lift it slowly while wiggling it gently around.
- ⓘ Immediately wipe off any chemicals like Saphoride that get on the basin.
- ⓘ Do not use a brush or other type of scrubber; this could scratch the basin. Do not use rough scrub brushes etc. that could scratch the surface. The basin cannot be autoclaved.
- ⓘ The basin is porcelain. Handle it carefully. Do not drop it or bang it.
- ⓘ Make sure the basin does not leak. If the basin is chipped, cracked or wobbly, contact your local dealer or J. MORITA OFFICE.
- ⓘ If the removed cup stand, basin, and the area around the basin unit are wet, wipe them off completely before reinstalling the parts.
- ⓘ If you run too much water to the basin at once, water may spill from the overflow hole. If water is spilled, wipe it off thoroughly from the basin stand and basin unit covers.

* The overflow hole is for discharging the drain water from the unit and preventing the drain water from mixing with the clean water supply line when the drainage line is clogged.



! WARNING

- Turn off the main switch while cleaning the basin bowl to avoid the risk of electric shocks or burns. Also, if the cup stand is not in place and the unit is turned on accidentally, water could get inside the basin pole unit and damage electrical components.

Regular Maintenance: Once a Month

Once a month, clean the flushing device, basin drain trap and filter, spittoon valve, and oil collection case for air turbine handpieces.

■ Clean Flushing Device

1



Turn the chair unit off. Lift up the flushing device and take it out.
Wash the upper and lower sections and the agitator in running water.

2

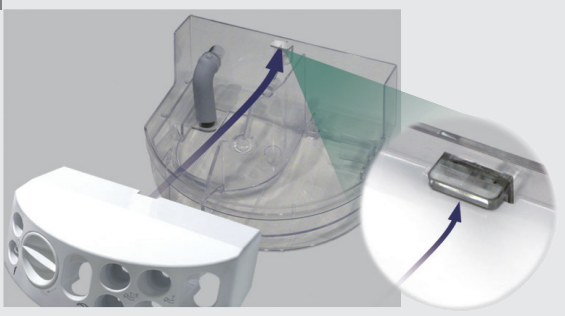

Reassemble the top and bottom sections of the flushing device.

⚠ Make sure the top part fits snugly under the projection on the top of the rear panel.

3



Reassemble and replace the device in its original position. Make sure it is level and that it goes all the way in past the stopper.

Regular Maintenance: Once a Month

■ Basin Drain Trap and Filter

1



Turn chair unit off.
Turn the trap in the direction shown by the arrow in the photo and take it off along with the filter. Wash the trap and filter in running water.

* Sometimes the filter stays inside the pipe when the trap is taken off.



2



Replace the trap and filter in the original positions.



! WARNING

- Turn off the main switch while cleaning the trap and filter to avoid the risk of electric shocks or burns.

! CAUTION

- After replacing the case, turn the unit on, run the water and check for leakage.

Regular Maintenance: Once a Month

■ Clean Oil Collection Case for Air Turbine System



The oil case for the air turbine system is underneath the tray. Empty it.

Wash the sponge and case in running water.

Squeeze all the water out of the sponge and reattach it. Screw the case all the way back on.

* If the turbine has a broken O-ring or if its spray is not working properly, a lot of oil might collect inside the case rather quickly.

Use the window slits to check this.

Check the handpieces.

■ Clean Spittoon Valve



* Refer to the DURR Company's user manual for instructions on cleaning this valve.

Regular Maintenance: Once Every Six Months

Vacuum Tank

Clean the vacuum tank every six months.

* Units with a central vacuum system do not have a vacuum tank.

1



Turn off the main switch.
Grip the handle to pull out the vacuum tank.



⚠ Have a bucket or some other container ready to catch any contaminated water that drips out of the tank.

2

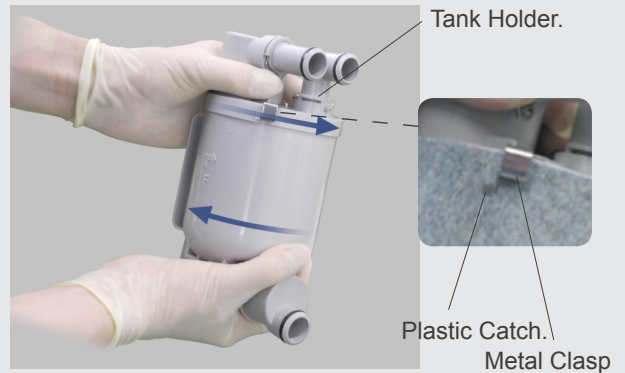

Turn the tank to release the metal clasp. Pull the tank straight down and take it off.

3



Wash out the inside of the tank with running water.

4

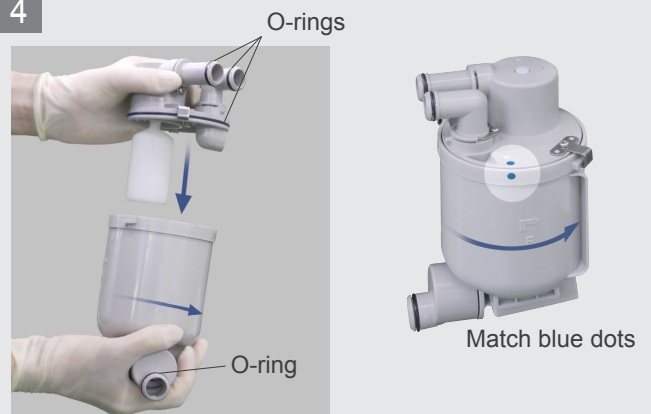

Put a little vaseline on the O-rings for the tank and the tank holder.
Put the tank back on the holder and turn it until the metal clasp is in place.

⚠ Replace O-rings if they are broken or worn out.

⚠ WARNING

• Turn off the main switch while cleaning the vacuum tank to avoid the risk of electric shocks or burns.

Regular Maintenance: Once Every Six Months

5



Line up the guide on the bottom of the vacuum tank with the rail and push the tank into place.

6



Press the tank firmly to secure it in place.



CAUTION

- Make sure the tank is properly and securely installed; otherwise water might leak.

Regular Maintenance: Once a Year

■ Replace Bacteria Filters and Case

Do this once a year, or whenever the air pressure to the threeway syringe seems weak.

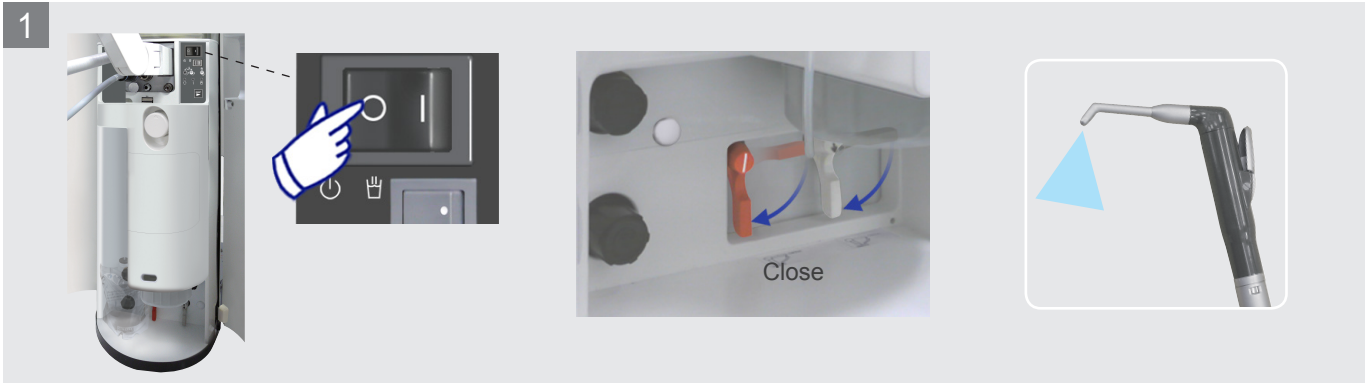

Turn the main switch off and close the main air and water valves. Operate the threeway syringe to remove internal pressure from the air and water lines. Do not fail to do this.

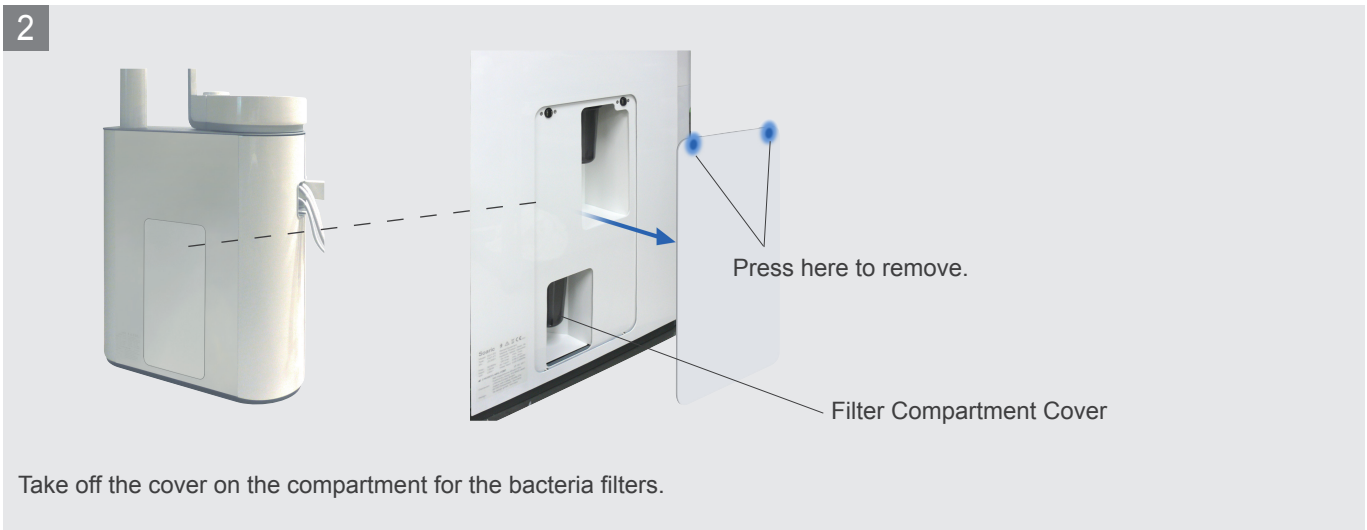

Take off the cover on the compartment for the bacteria filters.

! WARNING

- Turn off the main switch while replacing the bacteria filters and case to avoid the risk of electric shocks or burns.

! WARNING

- Be sure to release the internal pressure before taking the filter cases off.

Regular Maintenance: Once a Year

3

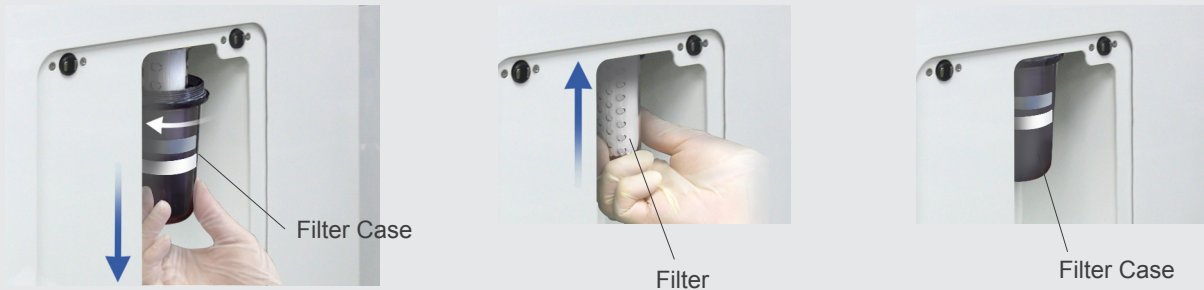

Remove the old filters and cases.

* Have a bucket or other container ready to catch any water that comes out when you take off the case for the water filter.

Put on the new water and air filters and cases. Write the installation date on the cases.



4

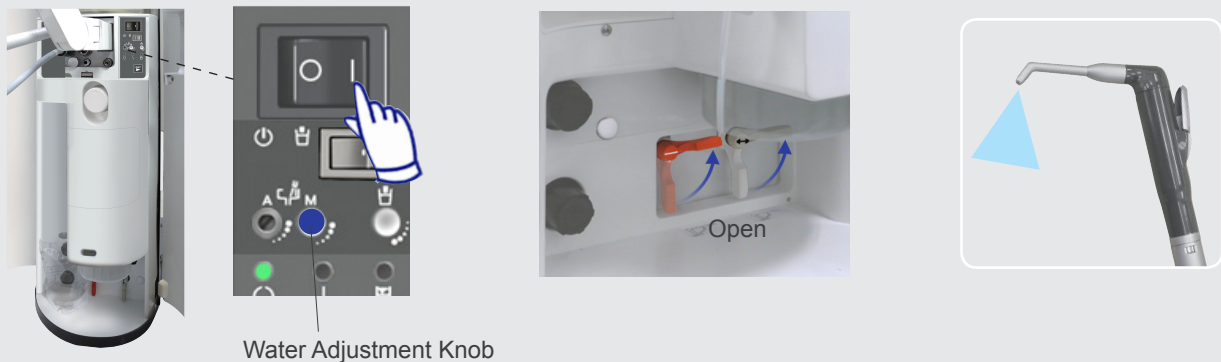

Turn on power and open main air and water valves. Make sure no air or water leaks from the cases. Open the water adjustment valve and spray water with the threeway syringe to get the air out of the case for the water filter. Then you can close the valve again.

Make sure the threeway syringe delivers air, water and spray properly.

5



Put the cover back on.

CAUTION

- Always replace the case as well as the filter. Old cases might leak.
- Make sure the filter is all the way on and securely installed. Tighten the filter case up securely. Otherwise air might leak.

Rinse Water and Vacuum Lines



This will rinse out the water and vacuum lines with tap water.

1



Grip this part firmly to swivel the instrument holder.

Raise the backrest and move the tray towards the backrest.
Swivel the instrument holders in the direction shown by the arrows in the photo.

2

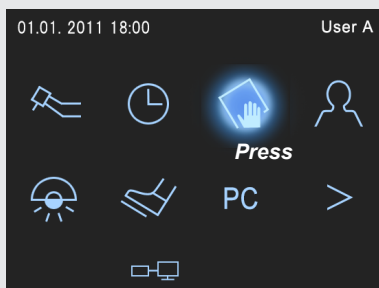

"Vacuum System and Water Line Rinsing"

Press the icon for the Vacuum System and Water Line Rinsing.

3



Put a dummy cup on the cup stand.
Press OK.

Rinse Water and Vacuum Lines



4



Put the instrument tubes into the flushing device. See page 108.
Press OK.

ⓘ If the tubes can't reach the flushing device, reposition the tray and chair so that they do (refer to step 1).

5



Press the Start icon. The clock will start its count down to show how long before the procedure has been completed.

* If you wish to stop the procedure, refer to the instructions for this on page 128.

6

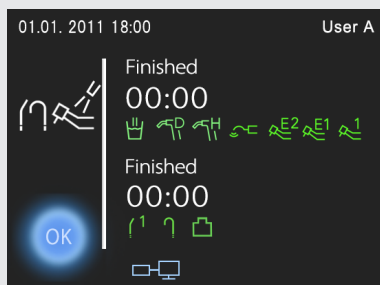

Press OK when the procedure has been completed.

7



Press OK when the procedure has been completed.
Take off the dummy cup and put all the instruments and tubes back in their holders.

Press OK.

ⓘ Before using the three-way syringe or the motor handpiece, blow air through them to get rid on any water inside the lines.



Stop Maintenance Procedure

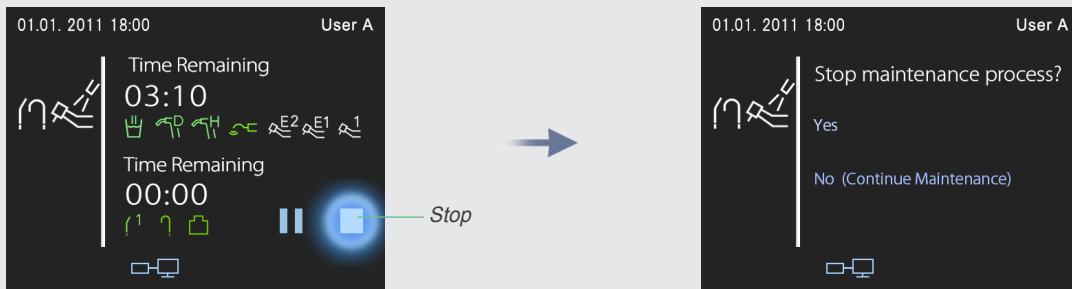

The display shown above appears if you stop the procedure. Press Yes or No and then press OK to go to the Home Page.

Decontaminate Vacuum Lines and Tank



This procedure decontaminates the vacuum lines and tank.

1

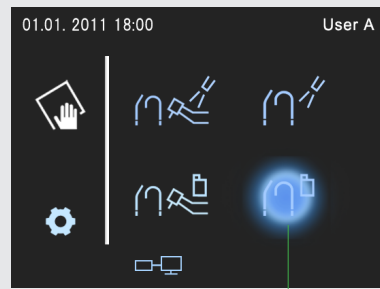
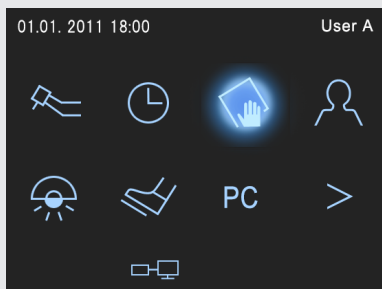

“Vacuum System Decontamination”

Press the Maintenance icon and then the Vacuum System Decontamination icon.

2



Make a liter of diluted Orotol Plus solution and pour about half in the basin.
Press OK.

* Refer to the separate user manual for the Durr Company's Orotol Plus.

Decontaminate Vacuum Lines and Tank



3



Put on adapter.



Pull out the tubes for the vacuum and saliva ejector. Take off the vacuum tip and the ejector tip. Put the tubes into the container for the Orotol Plus solution.

Press OK after the instruments have all been put in place.

4

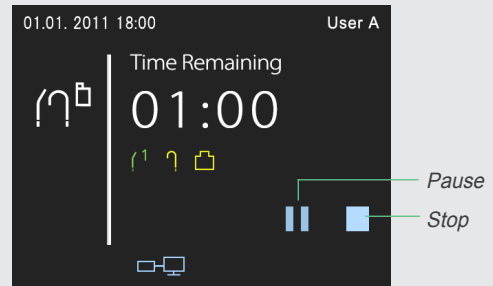

Press the Start icon. The clock will start its count down to show how long before the procedure has been completed.

* If you wish to stop the procedure, refer to the instructions for this on the next page.

5

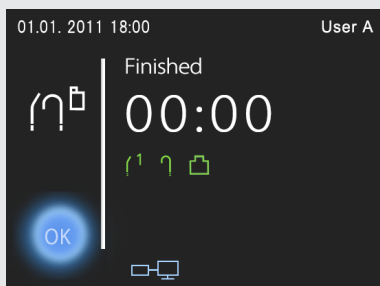

Press OK when the procedure has been completed.

6



Put the tubes back in their holders, close the maintenance cover, and press OK.



Stop Maintenance Procedure



The display shown above appears if you stop the procedure. Press one Yes or No.



WARNING

- If you leave the cleanser inside the water lines, be sure to flush out the cleanser before using the unit for treatment. Never use the unit for treatment when the cleanser remains inside the clean water supply lines.

(2) Replacement Parts

* Replace the parts as necessary depending on degree of wear and length of use.

* Order parts from your local dealer or J. MORITA OFFICE.

Replacement Parts for Air Turbines



O-ring Replacement

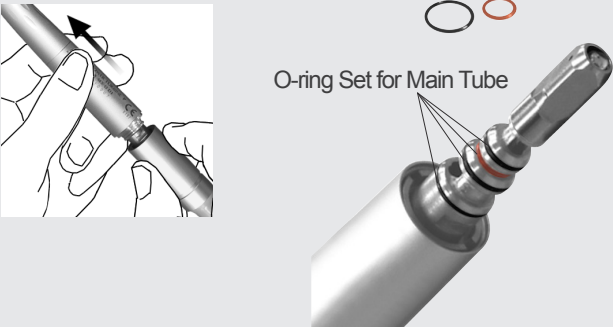

1



Take off the handpiece.
After replacing the O-rings, lightly spray them with AR Spray oil.



2



Put the handpiece back on and operate it to make sure it works properly.

- ⓘ Use only the O-rings specified for the main tube.
- ⓘ Use only AR Spray to lubricate the O-rings. Other types of oil could cause the O-rings to swell up and make it hard to put the handpiece on and take it off. Absolutely never use vegetable oils sold by other companies; these types of oil can get inside the handpiece and damage it.

! WARNING

- Turn off the main switch before replacing the O-rings to avoid the risk of electric shocks or burns.

! WARNING

- Replace all the O-rings at the same time. Otherwise, the handpiece may be blown off the tube.

! CAUTION

- Avoid getting burned by the LED or the LED cover, which can get quite hot. Wait for them to cool off before replacing the O-rings.

Replacement Parts for Air Turbines

■ Replace LED Light for light-equipped models



1

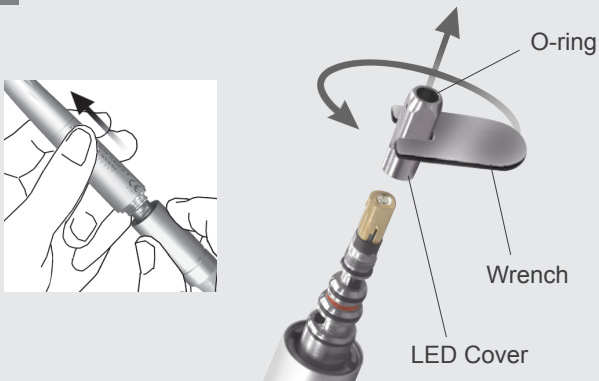

Take off the handpiece.
Take off the LED cover with the wrench.



ⓘ Replace the O-rings if water or air leak from the handpiece connection.

2

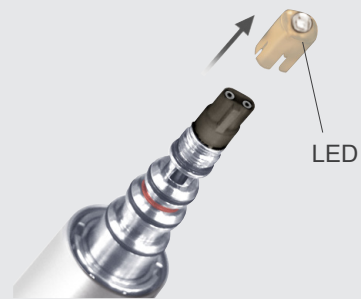

Take the old LED out of its socket.

3

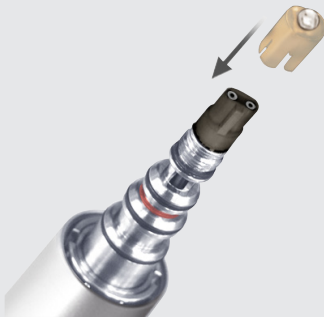

Line up grooves and ridges and slide the new LED straight on.

4



Screw the lamp cover on with your fingers and then tighten it up with the wrench.
Put the handpiece back on the tube and see if the light works properly.



! WARNING

- Turn off the main switch before replacing the LED to avoid the risk of electric shocks or burns.

! WARNING

- Make sure the LED cover is properly tightened up; otherwise, the handpiece connection might not be secure and air pressure could blow the handpiece off the end of the tube.
- Do not shine the LED directly into the eye. This could impair one's eyesight.

! CAUTION

- Avoid getting burned by the LED or the LED cover, which can get quite hot. Wait for them to cool off before replacing the LED.
- If the O-ring inside the end of the LED cover is missing or deformed by excessive tightening, the light might not be bright enough or malfunction.

Parts Replacement for Threeway Syringe

LED Replacement for light-equipped models



1



Take the nozzle off the syringe and remove the LED cover by turning it in the direction indicated by the arrow in the illustration.



2

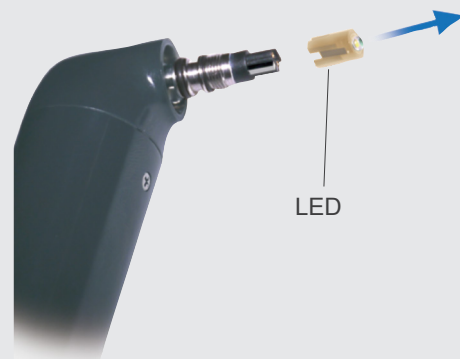

Take the LED out of its socket.

3

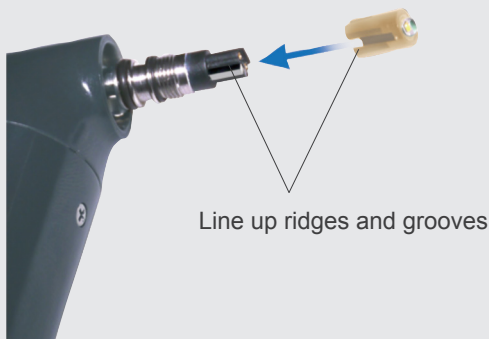

Line up the ridges and grooves and push the new LED straight into place.

4



Replace the LED cover. Slide the nozzle in until it clicks into place. Connect the syringe to its tube and see if the light works properly.



ⓘ Water or air might leak if the LED cover is not tightened up properly.

ⓘ WARNING

- Turn off the main switch before replacing the LED to avoid the risk of electric shocks or burns.

⚠ WARNING

- Do not shine the LED directly into the eye. This could impair one's eyesight.

⚠ CAUTION

- Avoid getting burned by the LED or the LED cover, which can get quite hot. Wait for them to cool off before replacing the LED.
- Make sure the nozzle click into place securely; otherwise, air pressure could blow it off the syringe.

Amalgam Collector Replacement

* Refer to the separate user manual provided by DURR company.



(3) Storage

Transport and Storage Conditions:

Temperature: -10°C to +70°C (+14°F to +158°F)

Humidity: 10% to 85% (without condensation)

Atmospheric Pressure: 70 kPa to 106 kPa

- Do not expose to direct sunlight frequently or for long times.
- If the unit has not been used for a long time, make sure it works properly before using.

Maintenance and Inspection

Regular Inspection

- Maintenance and inspection are generally considered to be the duty and obligation of the user, but if, for some reason, the user is unable to carry out these duties, he may rely on a qualified medical device serviceman. Contact your local dealer or J. MORITA OFFICE for details.
- This apparatus should be inspected every 6 months in accordance with the following maintenance and inspection items.

Maintenance and Inspection Items

Chair

1. Check main power supply voltage.
Use an analog or digital tester to measure the voltage. Standard: 220, 230, 240 V \pm 10%.
2. Floor and attachment to floor.
Visual inspection. Make sure floor is level and chair attachment has not loosened up.
3. Manual chair movement.
Move the seat and backrest up and down 3 times with the foot control or manual switches to make sure that it operates normally.
4. Automatic chair movement.
Use the auto position switches to move the chair 3 times and make sure it works normally. Jerky or squeaky movement should be considered abnormal.
5. Emergency stop test.
Press auto positioning switch and then stop the chair by pressing the chair lock switch. Repeat 3 times.
6. Safety Switch Test
Create an obstacle to the chair's movement wherever there's a safety switch. Make sure the chair stops moving when the switch is activated. Check that error and position of the safety switch is shown in the System Display. Repeat 3 times.
7. Seat
Make sure the seat is secure and stable and moves without wobbling or squeaking.
8. Headrest
Make sure the headrest is secure and stable and moves without wobbling or squeaking.
Adjust the headrest manually and make sure it works properly and smoothly. Repeat each of the following adjustments 3 times.
 - Vertical slide
 - Vertical lock
 - Vertical lock release
 - Angle of headrest
9. Backrest
Make sure the seat is secure and stable and moves without wobbling or squeaking.
Adjust the backrest manually and make sure it works properly and smoothly. Repeat each of the following adjustments 3 times.
 - Vertical slide
 - Vertical lock
 - Vertical lock release

Maintenance and Inspection Items

10. Electrical wiring

Check the electrical wiring for all printed circuit boards, components and elements.

 - Make sure all printed circuit board connections are secure.
 - Check for frayed or damaged insulation.
 - Check for broken, bent, twisted, or pinched wires.
11. Hydraulic System for chair movement

Move the chair with the seat and backrest levers or auto positioning switches and check the following components for oil leakage and abnormal noise:

 - Motor pump
 - Solenoid valve and servo valve
 - Elevation cylinder
 - Thin flexible tubing
12. Tubes and pipes for drain, water, air and vacuum

Visually inspect the tubing and pipes inside the unit.
Check for bent, pinched or bloated tubes.
Visually inspect tubing for drain and vacuum for damage, hardening (brittleness) and wear. Make sure connections do not leak.
Bleed (remove water from) the air tubes, regulator and compressor.
13. Bacteria Filter Cases

Visually inspect the cases including the threads and bottom for cracks and chips.
14. Seat, Backrest, Headrest, and Armrest (FT)

Make sure these components are all securely and properly installed. Check that they are not loose, do not wobble and do not squeak or make any other unusual noise.
15. Screw tightness.

Make sure all screws and bolts both inside and outside are in place and properly tightened.
16. Internal cleanliness

Look for dirt, dust or other contamination inside the unit and clean it as necessary.

Vacuum System and Water Line Decontamination

17. For Water Decontamination System
 - Make sure the level of the cleanser goes down during decontamination.
 - Make sure water comes out of the cup water fountain and the various instruments during flushing.
18. For Cleanser Bottle System
 - Make sure level of cleanser in bottle goes down during decontamination.
 - Make sure water comes out of the cup water fountain and the various instruments during flushing.
 - Make sure the bottle top is tightened up properly.
19. Vacuum Decontamination

Make sure level of cleanser in bottle goes down during decontamination.

Maintenance and Inspection Items

Air Turbine Handpiece

20. Handpiece and tube connections.
Make sure the handpiece can be connected and disconnected properly. Give the handpiece a light tug to make sure it is securely connected. Repeat 3 times.
21. Rotation and Spray
Make sure the handpiece rotates and delivers spray properly. Check that pressure gauge inside backrest reads 0.35 MPa 3.6 kgf/cm² when handpiece is running.
22. Spray, Air and LED light
Make sure the LED light works and that no air or water leak from the main tube connection.
23. AI Tube Catch
Turn on the AI Tube Catch and make sure it grabs the tube when the air turbine starts running.
Make sure tube is released after the specified time when turbine stops.

Micromotor Handpiece

24. Air, water and electricity
Check the electrical leads in the connection end of the main tube.
Make sure there is no air or water leakage.

Threeway Syringe

25. Threeway Syringes
Check threeway syringes for the following.
 - Emits water, air and spray when the levers are pressed.
 - Make sure the lock between the levers disables the water lever.
 - Nozzle connection, rotation, and removal.
 - Levers do not wobble or twist.
 - Body and case can be separated and put together again.
 - Leakage at the syringe-tube connection.

Vacuum Syringe

26. [Check for the following:]
 - Syringe suction start and stop.
 - Check that the strength of the vacuum can be set with the slider adjustment.
 - Tube connection and syringe rotation.
 - Body and tube connection attachment and detachment and damage or wear.
 - Leakage at the syringe-tube connection.
 - Press the auto-cleaning switch and make sure that the vacuum line and tank are cleaned.

Maintenance and Inspection Items

Basin

27. Cup filler
 - Manual : Put a cup in place and press the manual filler switch to make sure it works.
 - Auto : Put a cup in place and make sure it is filled to the proper level and that the basin is rinsed at the same time.
28. Basin
 - Check visually for cracks, chipping etc.
29. One-touch Connectors
 - Make sure the water and air flow properly.
 - Make sure there is no leakage.
30. For Auto Swing Basin
 - Make sure the basin swings over towards the patient chair when you press auto position switch S.

Tray

31. [Check for the following:]
 - Tray Arm Joints Movement and Braking Screw Integrity
 - Make sure tray arm does not wobble and moves smoothly.
 - Visually inspect arm joints for cracks, wear, or other damage.
 - Make sure joints do not wobble, are not loose and will not come apart.
 - Make sure all screws are properly tightened and will not come out.

* For the spittoon valve, amalgam separator and the equipment for the water decontamination system, refer to the separate user manuals for these components.

* For repairs contact your local dealer or J. MORITA OFFICE.

Maintenance and Inspection Items

■ Disposal of Medical Devices

Any medical devices which could possibly be contaminated must be first decontaminated by the responsible doctor or medical institution and then be disposed by an agent licensed and qualified to handle medical and industrial waste.

■ Service

Soaric may be repaired and serviced by:

- The technicians of J. MORITA's subsidiaries all over the world.
- Technicians employed by authorized J. MORITA dealers and specially trained by J. MORITA.
- Independent technicians specially trained and authorized by J. MORITA.

Troubleshooting

If the equipment does not seem to be working properly, the user should first try to inspect and adjust it himself.

* If the user is unable to inspect the equipment himself or if the equipment fails to work properly after being adjusted or after parts are replaced, contact your local dealer or J. MORITA OFFICE.

Problem	Check Points	Response
Chair		
Chair does not move	• Check display: Is chair safety switch activated?	• Safety switch is activated. Remove obstacle. (Refer to safety switch instructions.) If this does not solve the problem, have chair inspected and repaired.
	• Check display: Is safety switch has not been activated.	• Is the Chair Lock switch on? Press the Chair Lock switch to release the lock If this does not solve the problem, have chair inspected and repaired.
	• The basin might be too close to the chair.	• Manually move the basin to its proper position.
Instrument does not work.	• The System Display does not change when an instrument is taken out.	• Have the chair inspected and repaired.
Air Turbine Handpiece		
Air Turbine does not run	• Air comes out of the end of main tube when the handpiece is disconnected and you step on the pedal.	• Check O-rings on end of tube. Replace O-rings, if necessary. Coat O-rings with vaseline etc. If O-rings are OK, replace handpiece's capsule cartridge. (Refer to manual for handpiece.) If this does not solve the problem, have handpiece repaired.
	• Air does NOT come out of the end of main tube when the handpiece is disconnected and you step on the pedal.	• Have chair inspected and repaired.
No handpiece spray even when spray is turned on.	• Water comes out of the end of main tube when the handpiece is disconnected and you step on the pedal.	• Check O-rings on end of tube. Replace O-rings, if necessary. Coat O-rings with vaseline etc. If O-rings are OK, clean the spray holes. (Refer to manual for handpiece.) If this does not solve the problem, have handpiece repaired.
	• Water does NOT come out of the end of main tube when the handpiece is disconnected and you step on the pedal.	• Have chair inspected and repaired.

Problem	Check Points	Response
Air Turbine Handpiece		
Handpiece light does not come on even when light is turned on.	<ul style="list-style-type: none"> • Disconnect handpiece, step on pedal and check LED light at end of main tube. • LED cover is loose. 	<ul style="list-style-type: none"> • Replace LED. (Refer to manual for handpiece.) If this does not solve the problem, have chair inspected and repaired. (Probable broken wire or short inside tube.) • Tighten the cover with the wrench.
Micromotor Handpiece		
Attachments will not operate.	<ul style="list-style-type: none"> • Motor doesn't run when attachment is removed and you step on pedal. 	<ul style="list-style-type: none"> • Make sure that cover nut connecting motor to the tube is securely tightened. If this does not solve the problem, have chair and motor inspected and repaired. (Probable broken wire or short inside tube.) If the motor runs after tightening the cover nut, put the attachment back on and try it again. If it still doesn't run, have the attachment inspected and repaired.
No spray for micromotor attachment even when spray is turned on.	<ul style="list-style-type: none"> • Disconnect attachment, step on pedal. No water from joint. • Disconnect attachment, step on pedal. Water runs. 	<ul style="list-style-type: none"> • Have chair inspected and repaired if no water. • Inspect micromotor joint O-rings. Replace O-rings, if necessary. Coat O-rings with vaseline etc. If O-rings are OK, clean the attachment air and water nozzle. (See manual for micromotor.) If this does not solve the problem, have the attachment repaired.
Micromotor light does not work even when light is turned on.	<ul style="list-style-type: none"> • Take off the attachment, step on the pedal and see if the LED in the joint works. 	<ul style="list-style-type: none"> • Replace LED, if necessary. (Refer to micromotor's manual.) If this does not solve the problem, have chair inspected and repaired. (Probable broken wire or short inside tube.)
Vacuum Syringe		
Weak suction.	<ul style="list-style-type: none"> • Take off cover on vacuum filter case and see if filter is clogged. • Make sure case and cover for vacuum filter are tight and properly installed. • Make sure connectors on top of vacuum tank are securely connected. • Clean vacuum tank. • If above steps fail to solve problem, have unit inspected and repaired. 	<ul style="list-style-type: none"> • Clean filter.

Problem	Check Points	Response
---------	--------------	----------

Threeway Syringe		
------------------	--	--

No air or no water	<ul style="list-style-type: none"> Take off the nozzle and press the levers. Water and air come out. 	<ul style="list-style-type: none"> Nozzle may be clogged. Clean by blowing air through connection end. Also wash with water. Also check for worn or defective O-rings.
	<ul style="list-style-type: none"> Take off the nozzle and press the levers. No water or air. 	<ul style="list-style-type: none"> Take off syringe case and reattach it. Line up blue marks and put case on until there is an audible click. If this does not solve the problem, valves in syringe body may be clogged. Have chair inspected and repaired.

Syringe light does not work even when light is turned on.	<ul style="list-style-type: none"> Replace LED. See manual for threeway syringe. If this does not solve the problem, have chair inspected and repaired. (Probable broken wire or short inside tube.) 	
---	---	--

Basin		
-------	--	--

Basin water drains too slowly or is sluggish.	<ul style="list-style-type: none"> Check basin filter and catch. 	<ul style="list-style-type: none"> Clean filter and catch.
	<ul style="list-style-type: none"> Drain trap or filter may be clogged. 	<ul style="list-style-type: none"> Clean trap and filter.
	<ul style="list-style-type: none"> If above steps fail to solve problem, have unit inspected and repaired. 	

Auto Cup Filler		
-----------------	--	--

Doesn't work	<ul style="list-style-type: none"> See if sensor on water spout is wet or dirty. 	<ul style="list-style-type: none"> Clean sensor.
--------------	---	---

Operating Light		
-----------------	--	--

Light does not turn on	<ul style="list-style-type: none"> Sensor may be disabled. 	<ul style="list-style-type: none"> Check the setting. (→ see page 75) If this is not the problem, have the light inspected and repaired. (A wire in the head or arm could be broken or shorted out.)
------------------------	---	--

Basin Cover		
-------------	--	--

Water leakage from under the basin cover.

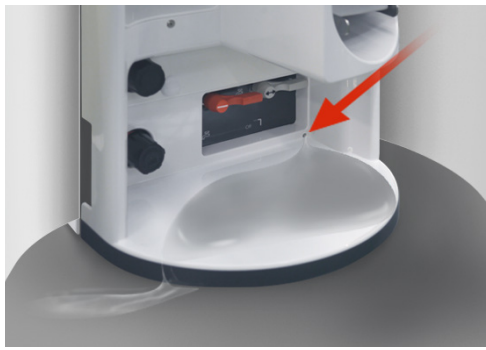

• Due to the potential of clog of internal drain water, contact your local dealer or J. MORITA OFFICE.

Home Page		
-----------	--	--

The confirmation message shown here appears.

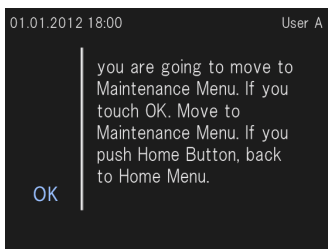

• Press the Home key on the operation panel to go back to the Home Page.

Problem

Check Points

Response

Other Error Messages

One of the error messages shown to the right has appeared.

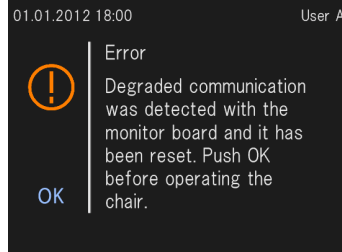

- Chair cannot move because of faulty communication with the monitor. Press OK to restart the monitor. If this happens frequently, contact J. MORITA OFFICE or your local dealer.

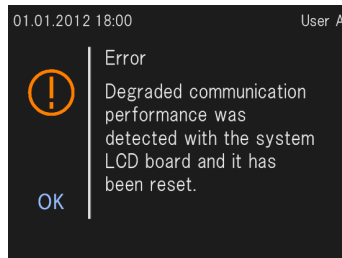

- Chair cannot move because of faulty communication with the System Display. Press OK to return to the original display. If this happens frequently, contact J. MORITA OFFICE or your local dealer.



- Handpiece cannot operate because of faulty communication with the monitor. Press OK to restart the monitor. If this happens frequently, contact J. MORITA OFFICE or your local dealer.

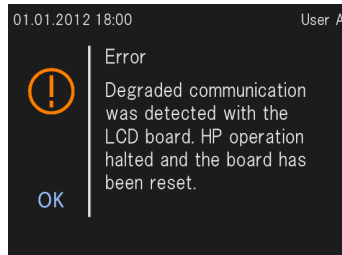

- Handpiece cannot operate because of faulty communication with the System Display. Press OK to return to the original display. If this happens frequently, contact J. MORITA OFFICE or your local dealer.

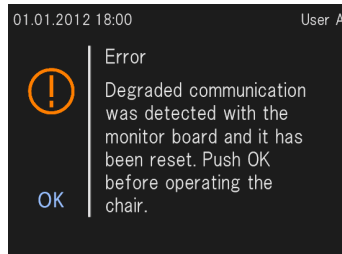

- Faulty communication with the monitor. Press OK to restart the monitor. If this happens frequently, contact J. MORITA OFFICE or your local dealer.

Problem

Check Points

Response

Other Error Messages

One of the error messages shown to the right has appeared.

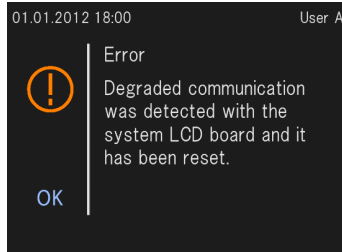

- Faulty communication with the System Display. Press OK to restart the monitor. If this happens frequently, contact J. MORITA OFFICE or your local dealer.

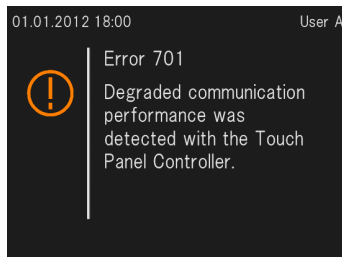

- There has been a transmission failure in an element on the system display board. Turn off the Soaric and then turn it on again. If this does not solve the problem, contact J. MORITA OFFICE or your local dealer for repairs.

Error Message on i-Dixel computer

If the error message shown to the right about the MID appears when starting up the computer, check the following and take the appropriate action.

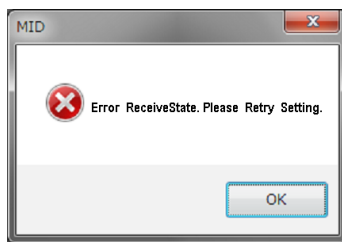

- Is the LAN cable connecting the Soaric and the computer together securely?
- Is the power to the HUB on? (If you use a HUB.)
- Connect the Soaric and the computer securely with the LAN cable, and then turn the power to the hub on. (If you use a HUB.)

Turn on the Soaric and restart the computer. Then, turn the Soaric off and then on once again.
(To restart the computer, press the power button of the computer to turn it off, confirm that the power lamp has gone out, and the press the power button again.)
If the error message is still displayed, contact your local dealer or J. MORITA OFFICE.

Technical Specifications

Specifications

* Specifications may be changed without notice due to improvements.

Model	DU-1-EX
Type	FMT-KT / FMT-FT / OTP-KT / OTP-FT
Intended Use	<p>The DU-1-EX is a general dental treatment unit. It is intended to be used for maintaining the patient's position and giving following operations as appropriate.</p> <ul style="list-style-type: none"> • Drilling or cutting teeth and prosthetic appliance to be removed • Cleaning and drying patient's oral cavity • Vacuuming saliva, cooling water, etc. from oral cavity • Periodontal treatment • Visualizing oral cavity • Composite resin restoration • Pulp extirpation and root canal treatment • Light irradiation to oral cavity
Essential Performance	None
Power Input Voltage	110 V
Frequency	50 / 60 Hz
Power Consumption	1.0 kVA
Protection against Electric Shock	CLASS I
Mode of Operation	non-CONTINUOUS Operation (Chair: max. 1 min On, min. 4 min Off)
Weight	Approx. 250 kg (included Chair, Basin unit, Tray, Operating light, Light pole, Foot control and Handpieces)
Maximum Loading Limit of Body Weight	135 kg
Operating Conditions	<ul style="list-style-type: none"> • Temperature: +10°C to +35°C (+50°F to +95°F) • Humidity: 30% to 75% (without condensation) • Atmospheric Pressure: 70 kPa to 106 kPa
Storage and Transportation Conditions	<ul style="list-style-type: none"> • Temperature: -10°C to +70°C (+14°F to +158°F) • Humidity: 10% to 85% (without condensation) • Atmospheric Pressure: 70 kPa to 106 kPa
Chair	
Hydraulic Motor	200 W condenser activated
Control	Solenoid Valve and Servo motor
Length	FMT-KT / OTP-KT: 1725 mm, FMT-FT / OTP-FT: 1600 mm
Width	625 mm
Height of the Seat (from floor)	Maximum (High): 800 ±10 mm, Minimum (Low): 380 ±10 mm
Angle of the Backrest	Maximum (Raised): 80°, Minimum (Reclined): 0°
Basin Unit	
Water Input	0.20 MPa to 0.59 MPa
Air Input	0.39 MPa to 0.78 MPa
Doctor Treatment Tray	
Maximum Loading Limit	2 kg
Assistant Auxiliary Tray	
Maximum Loading Limit	1 kg
Foot Control	
Protection against Ingress of Water	IPX1 (foot control) **1

Specifications

Operating Light (LED)	
Height (from floor)	Maximum 1700 ±100 mm, Minimum 1200 ±100 mm
Light Brightness	30,000 Lux (700 mm away from light head)
APPLIED PARTS	
* For scalers and implant motors made by other companies, the applied part is as specified by the manufacturer.	
<ul style="list-style-type: none"> • Air Turbine Handpiece • Micromotor Handpiece (except CA-10RC-ENDO) • Three Way Syringe • Vacuum Syringe • Saliva Ejector • Headrest (including electric type or dual axis type) • Chair Seat 	Type B applied parts
<ul style="list-style-type: none"> • Electronic Apex Locator • Scaler Handpiece (SC-7000) • Micromotor Handpiece (CA-10RC-ENDO) 	Type BF applied parts
Other Parts for Connection	
Charger	Connected with devices specified by J. MORITA MFG. CORP. (VL-10 etc.)
Other Scalers (made by other companies)	These scalers may also be connected: ACTEON SP NEWTRON LED Series EMS EJ-120A Series For details refer to the relevant installation and operation manuals.
Other Implant Motors	The implant motor system noted below may be connected. Bien-Air MX-i and MX-i LED Series For details refer to the relevant installation and operation manuals.
Accessories	Instruments, Vacuum tip, Vacuum nozzle, Tray sheet, Handle for Operating light, Operating light, Joint for air-connection, Joint for water-connection, Joint for vacuum-connection

*1 Refrain from the use of the Soaric in area with wet floors such as emergency rooms or operating rooms.

Specifications

Requirements for Computers or Other Devices Connected to DU-1-EX

Some of the following kinds of device may cause some technical problems with DU-1-EX. Use the devices with the following requirements (specifications and standards). If the devices are applicable, ask for J. MORITA OFFICE for proper selection of equipment or connections.

Windows Based Personal Computer

■ Practicable Application: i-Dixel (When using the other, contact with J. MORITA OFFICE)

Network	10BASE-T	
Video Output	Analog RGB or HDMI (exclusive monitor)	
Standard	<ul style="list-style-type: none"> • IEC 60950-1 • Related UL Standard (U.S.A.) • Local regulations 	<ul style="list-style-type: none"> • EMC regulation • Related C-UL Standard (Canada)
■ Hub: 10BASE-T, Non intelligent Shared HUB		
Standard	<ul style="list-style-type: none"> • IEC 60950-1 • Related UL Standard (U.S.A.) • Local regulations 	<ul style="list-style-type: none"> • EMC regulation • Related C-UL Standard (Canada)
■ Monitor (installed at pole)		
Weight	Maximum 5 kg (When using the heavier, contact with J. MORITA.)	
Standard	<ul style="list-style-type: none"> • IEC 60950-1 • Related UL Standard (U.S.A.) • Local regulations 	<ul style="list-style-type: none"> • EMC regulation • Related C-UL Standard (Canada)

Usability Statement

The DU-1-EX conforms to the Standard IEC 62366:2007 for usability.

Use this device with the following application specifications.

Patient Population	
Age	Child (with a first tooth) to Geriatric
Weight	Not over 135 kg body weight
Health	It is not intended for use on patients wearing pacemakers or ICDs.
Condition	Conscious and mentally alert person. (Person who can stay still during treatment.)
Part of the Body or Type of Tissue Applied to or Interacted with	
Teeth, gingiva, or skin	
Intended Operator	
Qualified and licensed dental treatment professionals	
User Qualifications	
Qualified and licensed dental treatment Dentist and Doctor	
Qualified and licensed dental treatment Hygienist	
Language Understanding	English

Symbols

* Some symbols may not be used.



Serial number



WEEE marking
Conforms with the WEEE Directive



Manufacturer



Date of manufacture



Type B applied part



Type BF applied part



Mandatory action



Refer to installations for use

IPX1

IP code
Liquid ingress protection: Level 1



Alternating current



This way up



Fragile



Keep away from rain



Temperature limitation



Humidity limitation



Atmospheric pressure limitation



GS1 DataMatrix

Electromagnetic Disturbances (EMD)

The Soaric (hereafter “this device”) conforms to IEC 60601-1-2:2014 Ed. 4.0, the relevant international standard for electromagnetic disturbances (EMD).

The following is the “Guidance and Manufacturer’s Declaration” which is required by IEC 60601-1-2:2014 Ed. 4.0, the relevant international standard for electromagnetic disturbances.

This is a Group 1, Class B product according to EN 55011 (CISPR 11).

This means that this device does not generate and/or use internationally radio-frequency energy, in the form of electromagnetic radiation, inductive and/or capacitive coupling, for the treatment of material or inspection/analysis purpose and that it is suitable for use in domestic establishments and in establishments directly connected to a low voltage power supply network which supplies buildings use for domestic purposes.

Guidance and Manufacturer’s Declaration – Electromagnetic Emissions		
This device is intended for use in the electromagnetic environment specified below. The customer or the user of this device should assure that it is used in such an environment.		
Emissions Test	Compliance	Electromagnetic Environment – Guidance
Conducted disturbance CISPR 11	Group 1 Class B	This device uses RF energy only for its internal function. Therefore, its RF emissions are very low and are not likely to cause any interference in nearby electronic equipment.
Radiated disturbance CISPR 11	Group 1 Class B	This device is suitable for use in all establishments, including domestic establishments and those directly connected to the public low-voltage power supply network that supplies buildings used for domestic purposes.
Harmonic current IEC 61000-3-2	Not applicable*	
Voltage fluctuations and flicker IEC 61000-3-3	Not applicable*	

* The nominal input voltage for the DU-1-EX is AC 110 V. These tests are not required if the nominal input voltage is less than AC 220 V.

WARNING

- The use environment of this device is the Professional healthcare facility environment.
- This device needs special precautions regarding EMD and needs to be installed and put into service according to the EMD information provided in the ACCOMPANYING DOCUMENTS.
- Use of parts other than those accompanied or specified by J. MORITA MFG. CORP. could result in increased electromagnetic emissions or decreased electromagnetic immunity of this device and result in improper operation.
- Do not use this device as adjacent or stacked as possible with other. When adjoining or stacking is necessary, use it after observing whether this equipment and other equipment work properly.
- Portable and mobile RF communications equipment (including peripherals such as antenna cables and external antennas) should be used no closer than 30 cm to any part of the DU-1-EX, including cables specified by the manufacturer.

Guidance and Manufacturer's Declaration – Electromagnetic Immunity			
This device is intended for use in the electromagnetic environment specified below. The customer or the user of this device should assure that it is used in such an environment.			
Immunity Test	IEC 60601 Test Level	Compliance Level	Electromagnetic Environment – Guidance
Electrostatic discharge (ESD) IEC 61000-4-2	±8 kV contact ±2 kV, ±4 kV, ±8 kV, ±15 kV air	±8 kV contact ±2 kV, ±4 kV, ±8 kV, ±15 kV air	Floors should be wood, concrete or ceramic tile. If floors are covered with synthetic material, the relative humidity should be at least 30%.
Electrical fast transients/bursts IEC 61000-4-4	±2 kV for power supply lines ±1 kV for input/output lines	±2 kV for power supply lines ±1 kV for input/output lines	Mains power quality should be that of a typical commercial or hospital environment.
Surge IEC 61000-4-5	<u>AC/DC power</u> ±0.5 kV, ±1 kV line(s) to line(s) ±0.5 kV, ±1 kV, ±2 kV line(s) to earth <u>Signal input/output</u> ±2 kV line(s) to earth	<u>AC/DC power</u> ±0.5 kV, ±1 kV line(s) to line(s) ±0.5 kV, ±1 kV, ±2 kV line(s) to earth <u>Signal input/output</u> — (*1)	Mains power quality should be that of a typical commercial or hospital environment.
Voltage dips, short interruptions and voltage variations on power supply lines IEC 61000-4-11	<u>dips</u> 0% U_T : 0.5 cycle (at 0, 45, 90, 135, 180, 225, 270, 315°) 0% U_T : 1 cycle (at 0°) 70% U_T : 25/30 cycles (at 0°) 25 (50 Hz)/30 (60 Hz) <u>short interruptions</u> 0% U_T : 250/300 cycles 250 (50 Hz)/300 (60 Hz)	<u>dips</u> 0% U_T : 0.5 cycle (at 0, 45, 90, 135, 180, 225, 270, 315°) 0% U_T : 1 cycle (at 0°) 70% U_T : 25/30 cycles (at 0°) 25 (50 Hz)/30 (60 Hz) <u>short interruptions</u> 0% U_T : 250/300 cycles 250 (50 Hz)/300 (60 Hz)	Mains power quality should be that of a typical commercial or hospital environment. If user of this device requires continued operation during power mains interruptions, it is recommended that this device be powered from an uninterruptible power supply or a battery.
Power frequency (50/60 Hz) magnetic field IEC 61000-4-8	30 A/m (r.m.s.) 50 Hz or 60 Hz	30 A/m (r.m.s.) 50 Hz and 60 Hz	Power frequency magnetic field should be at levels characteristic of a typical location in a typical commercial or hospital environment.
NOTE 1: U_T is the a.c. mains voltage prior to application of the test level. NOTE 2: r.m.s.: root mean square			

*1: Not applicable because it does not connect directly to outdoor cable.

Guidance and Manufacturer's Declaration – Electromagnetic Immunity

This device is intended for use in the electromagnetic environment specified below.
The customer or the user of this device should assure that it is used in such an environment.

Immunity Test	IEC 60601 Test Level	Compliance Level	Electromagnetic Environment – Guidance
Conducted RF IEC 61000-4-6	3 V ISM ^(c) / amateur radio frequency band: 6 V 150 kHz to 80 MHz	3 V ISM ^(c) / amateur radio frequency band: 6 V 150 kHz to 80 MHz	Portable and mobile RF communications equipment should be used no closer to any part of this device, including cables, than the recommended separation distance calculated from the equation applicable to the frequency of the transmitter.
Radiated RF IEC 61000-4-3	3 V/m 80 MHz to 2.7 GHz	10 V/m 80 MHz to 2.7 GHz	Recommended separation distances
	27 V/m 385 MHz	27 V/m 385 MHz	$d = 1.2\sqrt{P}$ 150 kHz to 80 MHz
	28 V/m 450 MHz	28 V/m 450 MHz	$d = 1.2\sqrt{P}$ 80 MHz to 800 MHz
	9 V/m 710, 745, 780 MHz	9 V/m 710, 745, 780 MHz	$d = 2.3\sqrt{P}$ 800MHz to 2.7 GHz
	28 V/m 810, 870, 930, MHz	28 V/m 810, 870, 930, MHz	$d = \frac{6}{E} \sqrt{P}$ Portable wireless RF communication equipment
	28 V/m 1720, 1845, 1970 MHz	28 V/m 1720, 1845, 1970 MHz	Where P is the maximum output power rating of the transmitter in watts (W) according to the transmitter manufacturer, E is the compliance level in V/m and d is the recommended separation distance in meters (m).
	28 V/m 2450 MHz	28 V/m 2450 MHz	Field strengths from field RF transmitters, as determined by an electromagnetic site survey ^(a) , should be less than the compliance level in each frequency range ^(b) .
	9 V/m 5240, 5500, 5785 MHz	9 V/m 5240, 5500, 5785 MHz	Interference may occur in the vicinity of equipment marked with the following symbol: 

NOTE 1: At 80 MHz and 800 MHz, the higher frequency range applies.

NOTE 2: These guidelines may not apply in all situations. Electromagnetic propagation is affected by absorption and reflection from structures, objects and people.

(a) Field strengths from fixed transmitters, such as base stations for radio (cellular/cordless) telephones and land mobile radios, amateur radio, AM and FM radio broadcast and TV broadcast cannot be predicted theoretically with accuracy. To assess the electromagnetic environment due to fixed RF transmitters, an electromagnetic site survey should be considered. If the measured field strength in the location in which this device is used exceeds the applicable RF compliance level above, this device should be observed to verify normal operation. If abnormal performance is observed, additional measures may be necessary, such as reorienting or relocating this device.

(b) Over the frequency range 150 kHz to 80 MHz, field strengths should be less than 3 V/m.

(c) The ISM (Industrial, Scientific and Medical) bands between 0.15 MHz and 80 MHz are 6.765 MHz to 6.795 MHz; 13.553 MHz to 13.567 MHz; 26.957 MHz to 27.283 MHz; and 40.66 MHz to 40.70 MHz.

■ Essential Performance

None

■ Cable List

No.	Interface(s):	Max. Cable Length, Shielding	Cable Classification
1.	WS-10-O-LD Main Tube	1.6 m, Un-shielded	Signal Line (Patient-Coupled cable)
2.	HS Main Tube (SFSO-1-LD)	1.6 m, Un-shielded	Signal Line (Patient-Coupled cable)
3.	HS Main Tube (ST-WH-O)	1.6 m, Un-shielded	Signal Line (Patient-Coupled cable)
4.	TR-S2 Main Tube	1.6 m, Un-shielded	Signal Line (Patient-Coupled cable)
5.	SC-7000 (-O) Main Tube	1.6 m, Un-shielded	Signal Line (Patient-Coupled cable)
6.	Implant Motor Cable	2.0 m, Un-shielded	Signal Line (Patient-Coupled cable)
7.	WS-12 Main Tube	1.7 m, Un-shielded	Signal Line (Patient-Coupled cable)
8.	Foot Control Cable	1.2 m, Un-shielded	Signal Line
9.	RGB Cable	> 3.0 m, Un-shielded	Signal Line
10.	LAN Cable	> 3.0 m, Shielded	Signal Line
11.	External Vacuum Cable	> 3.0 m, Un-shielded	Signal Line



Development and Manufacturing

J. MORITA MFG. CORP.

680 Higashihama Minami-cho, Fushimi-ku, Kyoto 612-8533, Japan
T +81. (0)75. 611 2141, F +81. (0)75. 622 4595

Morita Global Website
www.morita.com

Distribution

J. MORITA CORP.

3-33-18 Tarumi-cho, Suita-shi, Osaka 564-8650, Japan
T +81. (0)6. 6380 1521, F +81. (0)6. 6380 0585

J. MORITA USA, INC.

9 Mason, Irvine CA 92618, USA
T +1. 949. 581 9600, F +1. 949. 581 8811

J. MORITA EUROPE GMBH

Justus-von-Liebig-Strasse 27a, 63128 Dietzenbach, Germany
T +49. (0)6074. 836 0, F +49. (0)6074. 836 299

MORITA DENTAL ASIA PTE. LTD.

150 Kampong Ampat #06-01A KA Centre, Singapore 368324
T +65. 6779. 4795, F +65. 6777. 2279

J. MORITA CORP. AUSTRALIA & NEW ZEALAND

Suite 2.05, 247 Coward Street, Mascot NSW 2020, Australia
T +61. (0)2. 9667 3555, F +61. (0)2. 9667 3577

J. MORITA CORP. MIDDLE EAST

4 Tag Al Roasaa, Apartment 902, Saba Pacha 21311 Alexandria, Egypt
T +20. (0)3. 58 222 94, F +20. (0)3. 58 222 96

J. MORITA CORP. INDIA

Filix Office No.908, L.B.S. Marg, Opp. Asian Paints, Bhandup (West), Mumbai 400078, India
T +91-22-2595-3482

J. MORITA MFG. CORP. INDONESIA

28F, DBS Bank Tower, Jl. Prof. Dr. Satrio Kav. 3-5, Jakarta 12940, Indonesia
T +62-21-2988-8332, F + 62-21-2988-8201

SIAMDENT CO., LTD.

71/10 Mu 5, Thakham, Bangpakong, Chachuengsao 24130, Thailand
T +66. 38. 573042, F +66. 38. 573043
www.siamdent.com

EU Authorized Representative under the European Directive 93/42/EEC



MEDICAL TECHNOLOGY PROMEDT CONSULTING GmbH

Altenhofstraße 80, 66386 St. Ingbert, Germany T +49. 6894 581020, F +49. 6894 581021

The authority granted to the authorized representative, MEDICAL TECHNOLOGY PROMEDT Consulting GmbH, by J. MORITA MFG. CORP. is solely limited to the work of the authorized representative with the requirements of the European Directive 93/42/EEC for product registration and incident report.

Diagnostic and Imaging Equipment

Treatment Units

Handpieces and Instruments

Endodontic System

Laser Equipment

Laboratory Devices

Educational and Training Systems

Auxiliaries