

# Veraviewepocs 3D R100



Thinking ahead. Focused on life.

# Veraviewepocs 3D R100

## **A New Frontier in X-ray Diagnostics**

Veraviewepocs 3D R100 has changed the shape of FOV. This unit's groundbreaking and patent pending 3D Reuleaux Full Arch FOV (field of view) provides a unique shape for full arch imaging. With 6 field of view options and Morita's world renowned image quality, Veraviewepocs 3D R100 is suitable for a wide variety of dental applications including implant planning.



3D Reuleaux Full Arch FOV



# 3D Reuleaux Full Arch Field of View

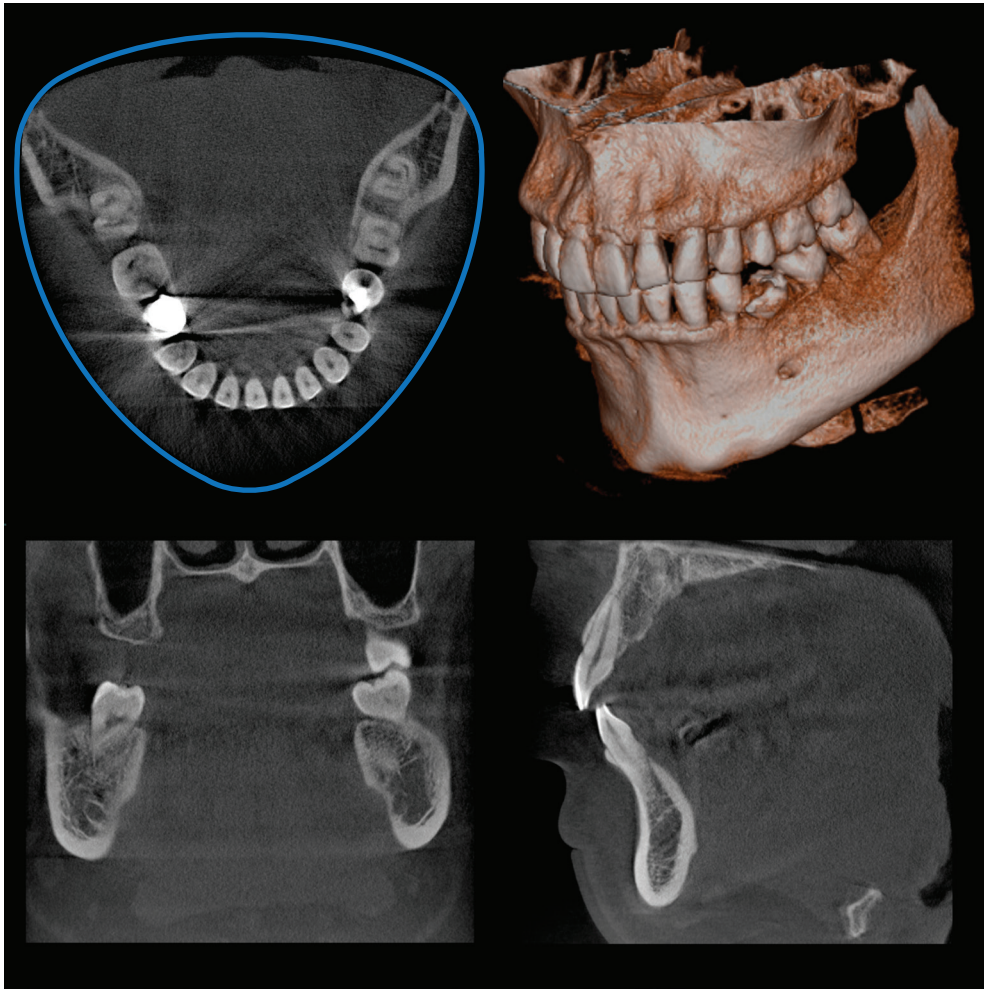

Blue line indicates full arch FOV, equivalent to  $\varnothing 100$  mm.

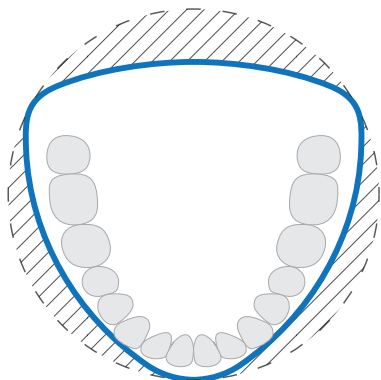

Reduce dose with the innovative 3D Reuleaux FOV.

## Patent Pending Technology

Morita's completely unique 3D Reuleaux Full Arch FOV abandons the typical cylinder with a convex triangle shape. By more closely matching the natural dental arch form, this groundbreaking FOV reduces dose by excluding areas outside the region of interest and allows a complete scan of the maxilla and/or the mandible.

# Various Fields of View

## Exposure Areas for Multiple Diagnostics

The Veraviewepocs 3D R100 model offers a total of 6 exposure areas from  $\text{Ø } 40 \times \text{H } 40 \text{ mm}$  up to  $\text{Ø } 100 \times \text{H } 80 \text{ mm}$  for various diagnostic needs.

The full arch scan captures the maxilla and/or the mandible with the equivalent of 100 mm in diameter and two height options of 50 or 80 mm. Its full arch capability, reduced dose, and exceptional clarity are ideal features for implant planning and oral surgery. This unit also offers small and medium field of view sizes suitable for endodontics, periodontics, as well as general dentistry.

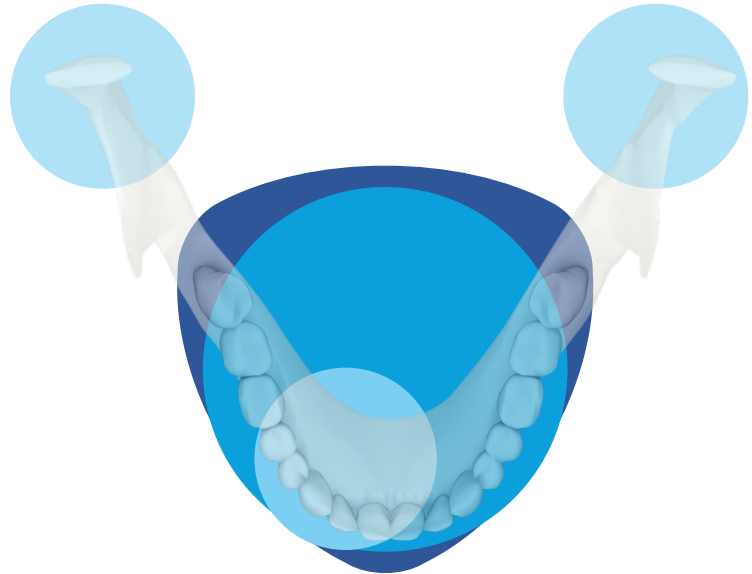

R100 Full Arch FOV

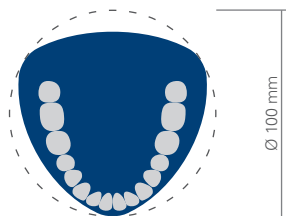

$\text{Ø } 80 \text{ FOV}$

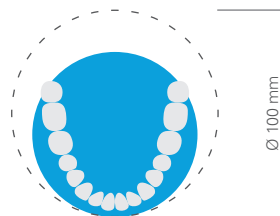

$\text{Ø } 40 \text{ FOV}$

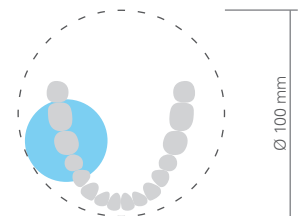

## Fields of View

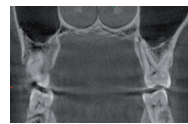
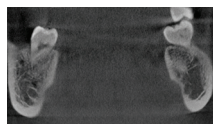

$\text{Ø } 100 \text{ (Equivalent)} \times \text{H } 80 \text{ mm}^*$

$\text{Ø } 100 \text{ (Equivalent)} \times \text{H } 50 \text{ mm}^*$

$\text{Ø } 80 \times \text{H } 80 \text{ mm}$

$\text{Ø } 80 \times \text{H } 50 \text{ mm}$

$\text{Ø } 40 \times \text{H } 80 \text{ mm}$

$\text{Ø } 40 \times \text{H } 40 \text{ mm}$

Veraviewepocs 3D R100

\*3D Reuleaux Full Arch FOV

# High Resolution Images With Dose Reduction Feature

## Dose Reduction Feature

Through advanced engineering, a Dose Reduction Mode optimizes the intensity of the X-rays which lowers exposure for easily penetrated tissues. Dose is reduced to a mere 60% of the standard mode.\* By maximizing efficiency, the maxillary sinus membrane appears sharper than ever before with fewer artifacts.\*\*

## Resolution & Clarity

Veraviewepocs offers high resolution images of 125  $\mu\text{m}$  voxel. It provides clear images of the periodontal pocket, the periodontal ligament, and the alveolar bone. It is extremely useful for implant therapy from planning to post-operative observation.

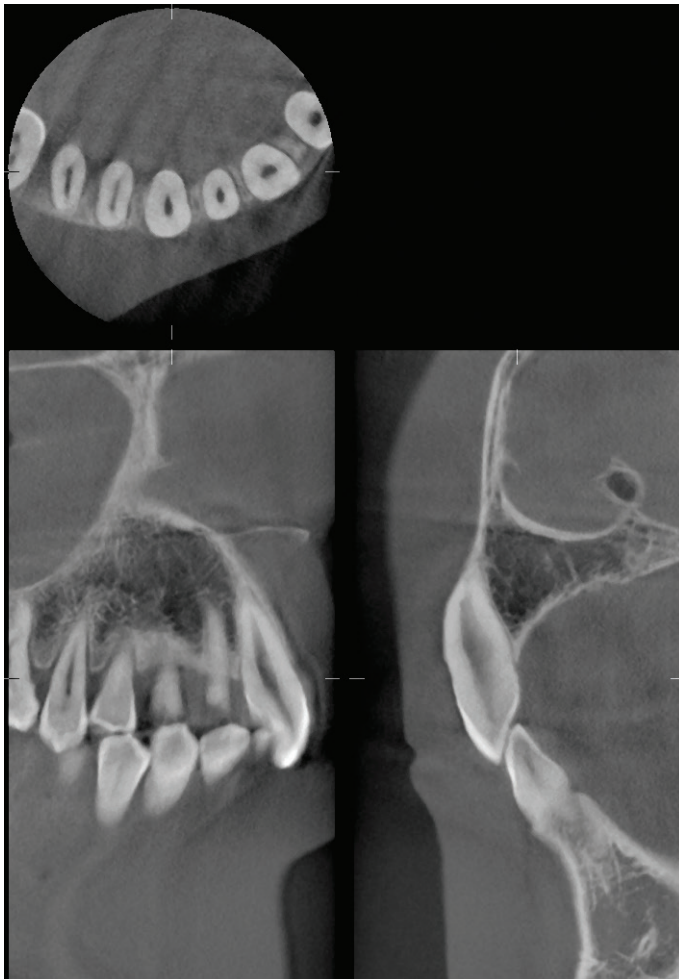

Ø 40 x H 80 mm high resolution image taken in Dose Reduction Mode

## Spatial Resolution MTF: Modulation Transfer Function

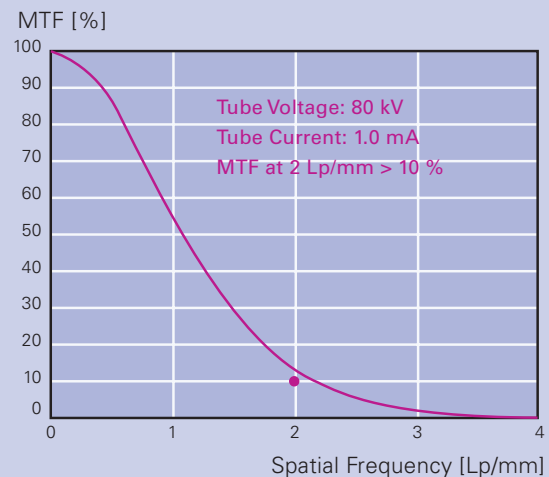

## Super-High Resolution for All Image Areas

The resolution of Veraviewepocs is greater than 2 line pairs per mm (MTF 10%). The highly detailed images have a voxel size of 0.125 mm per side, and the slice thickness and interval can be set between 0.125 and 12.375 mm.

Note: The largest field of view of the Veraviewepocs 3D R100 model, Ø 100 mm (Equivalent) x H 80 mm, offers a voxel size of 0.16 mm.

\* For Ø 40 X H 80 mm exposures. \*\* Compared to standard exposure mode.

# Easy 3D Positioning

## Flexibility

Veraviewepocs offers flexibility in positioning methods. The region of interest can be positioned by the panoramic image, the bi-directional scout, or the 5 positioning laser beams.

## Panoramic Image with Scout Feature

Before taking a 3D image, a high resolution panoramic exposure is taken to target the region of interest on the PC monitor. The C-arm will automatically move into the optimum patient position to get 3D images at the center of the region of interest.

## Two-Direction Scout

After initial positioning is accomplished by the 3 positioning laser beams, bi-directional X-ray images can be taken to confirm that the position is accurate. If it is not, simply adjust the position of the image on the computer by placing the cursor at the center of the region of interest.

## Direct Positioning with Laser Beams

Positioning laser beams set the patient's position and align the region of interest manually.

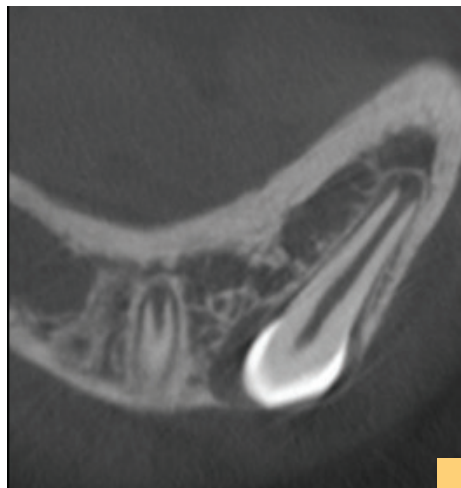
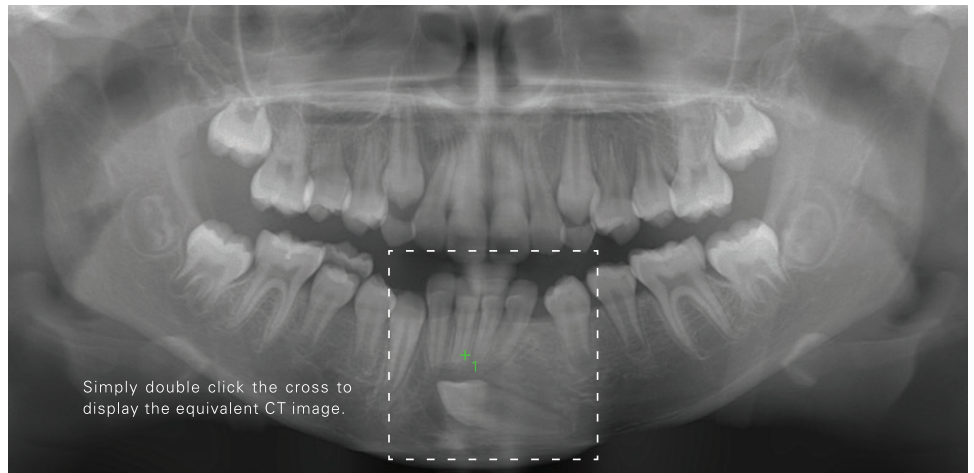

## Clinical Case Example

The panoramic image above reveals a horizontally impacted left mandibular canine. Further inspection with a 3D volume shows the relationship of the impacted tooth and the anterior mandibular incisors. It also reveals widening of the follicular sac suggesting the presence of a dentigerous cyst.



# 3D Images for Implant Planning

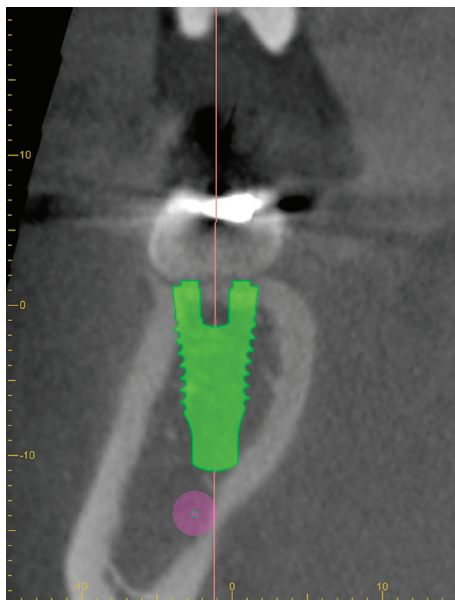
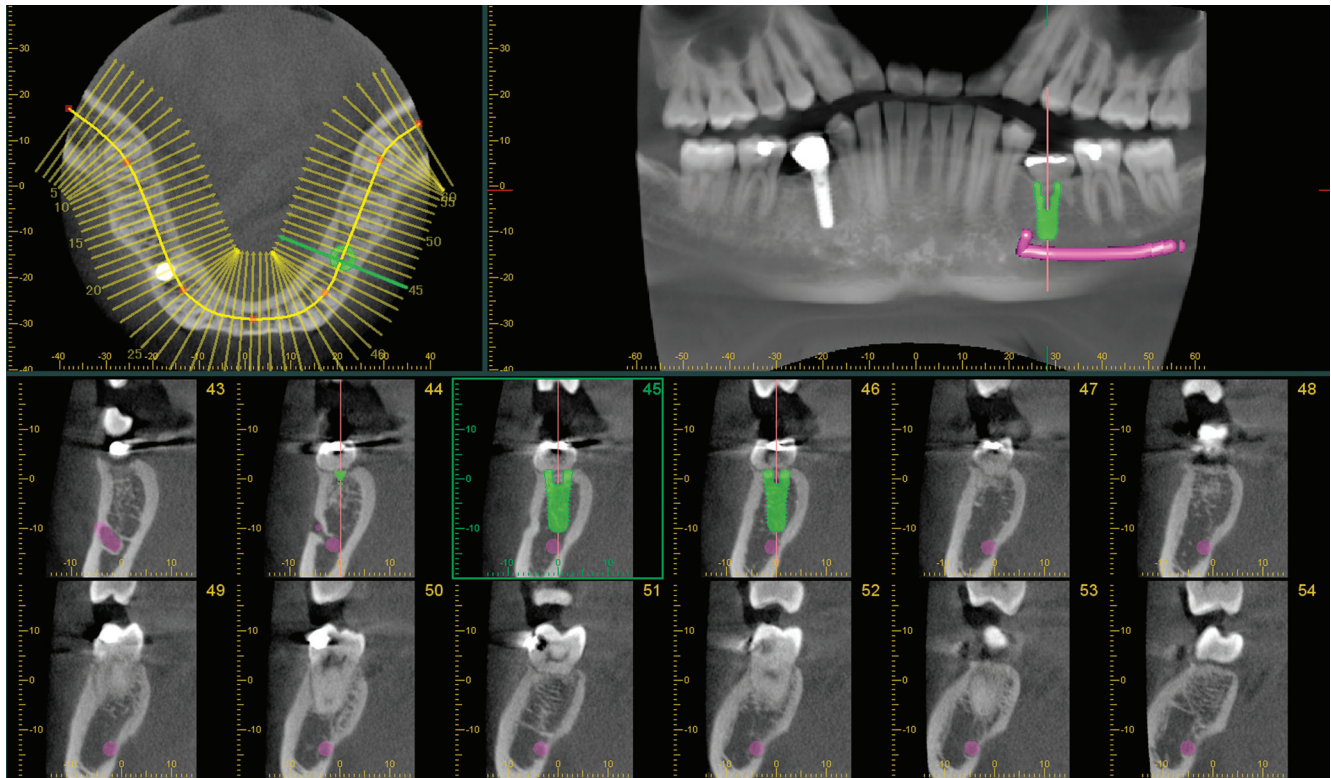

## Planning Process

Successful placement of implants starts with the very critical and detailed planning process. Identification of structures such as the sinus cavity, inferior alveolar nerve, and clear views of the bone structure are needed.

Veraviewepocs 3D R100 is ideal for implant planning with full arch imaging, industry leading clarity, and low dose to the patient.

## Software

i-Dixel 2.0 software offers advanced implant planning features, plus compatibility with popular third party software.

## cMPR Image Processing

Create cross sectional images of the dental arch.

## Mandibular Canal Tracing

Highlight the mandibular canal for easier viewing, measuring the distance to the implant and determining its buccal and lingual position.



# Panoramic Imaging



After focal plane adjustment

## AF Automatic Positioning

This function makes patient positioning nearly effortless. A light beam sensor automatically positions the unit without requiring the patient to move. The light beam sensor measures the distance to the patient's teeth, then the arm automatically moves into the optimal position. This process produces images with a high degree of reproducibility.

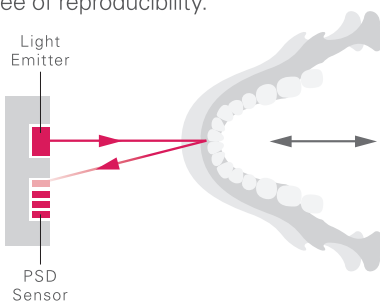

AF Automatic Positioning Technology

## DDAE (Digital Direct Auto Exposure)

The DDAE function controls X-ray emission in real time depending on the area being examined and produces a wide dynamic range, as well as sharp and exceptionally clear images.

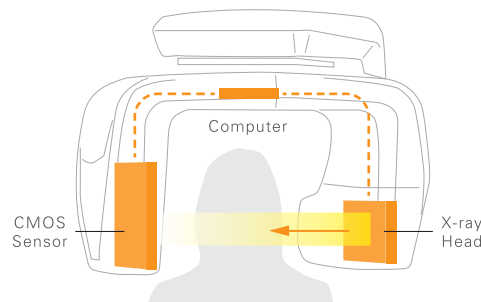

DDAE Mechanism

## AIE (Auto Image Enhancement)

This software processing function uses a logarithmic conversion to adjust the overall density and to highlight shaded details, creating a better image.

## Standard Panoramic

The X-Y movement and arm rotation are coordinated by a computer control system to create a projection with the optimum image layer shape.

## Orthogonal Panoramic

This projection controls the angle of X-ray penetration to reduce the overlapping of individual teeth.

## Shadow Reduction Panoramic

This projection controls the angle of X-ray penetration to reduce the mandibular ramus shadow.

# Partial Panoramic Function

When a full panoramic image is not required, 1 to 5 sections of the panoramic image, as well as the maxillary sinus, can be excluded to expose only those areas within the region of interest. By excluding parts of the dental arch, dose is reduced.

The partial panoramic function is easy to operate. Simply press the Partial Panorama key and the panoramic and maxillary sinus appear with equally divided sections. Select any to exclude them from the irradiation area.

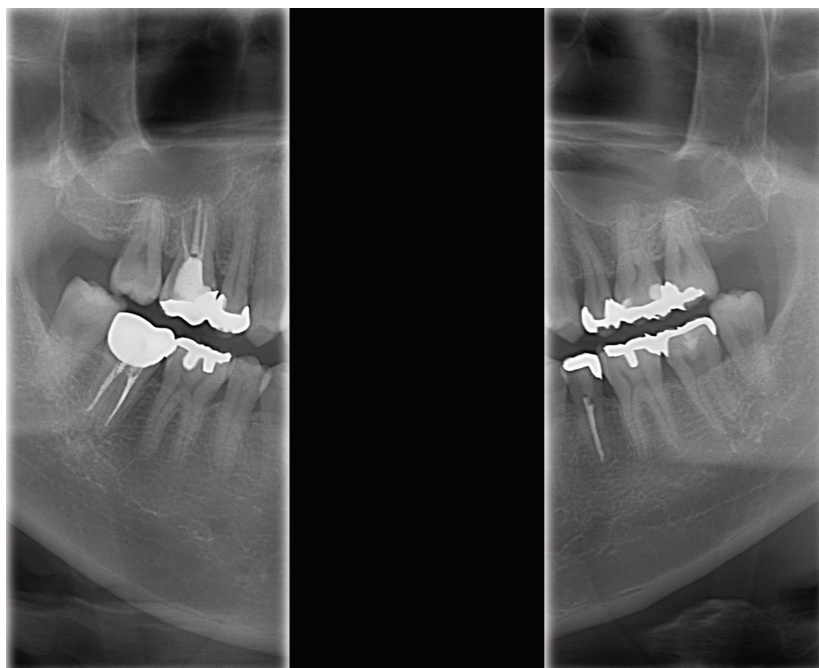
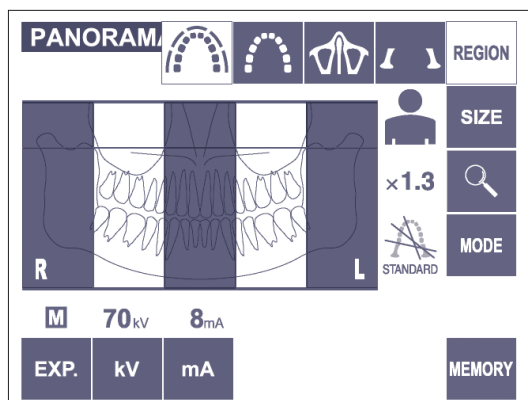
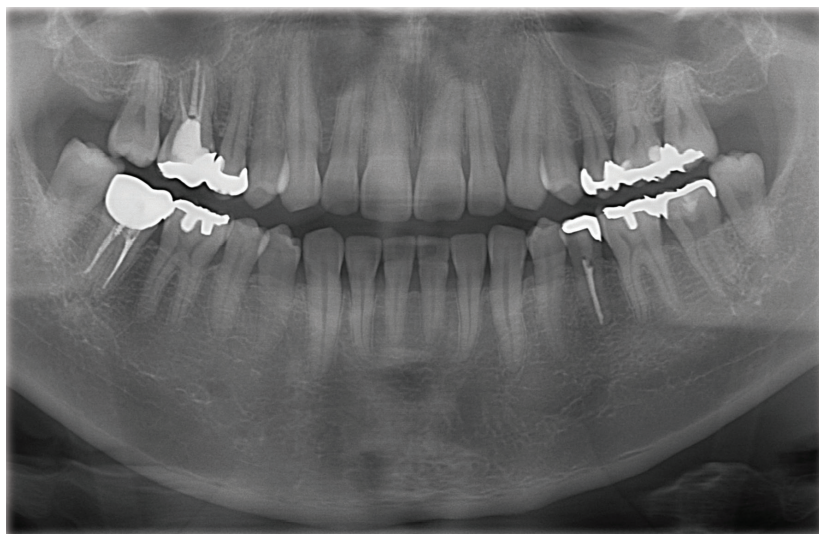
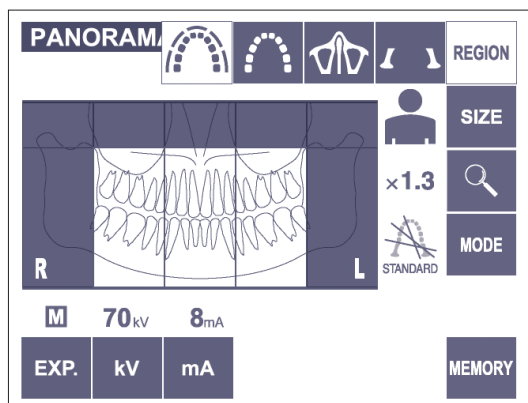

# Cephalometric Imaging

## High Speed

The Veraviewepocs system offers high speed performance requiring only 2.6 to 5.8 seconds for a lateral projection. The speed helps ensure high quality images each and every time. For pediatric patients, the reduced scan time is especially helpful as repeat images due to patient movement are virtually eliminated.

## Low Dose

With only a tenth of the dose compared to a conventional X-ray\*, the exposure level is significantly reduced.

## High Quality Image with Wide Dynamic Range

You obtain far more information about hard and soft tissue – with just a single acquisition.

## Variable Imaging Processing

The variable image processing technique generates optimum grayscale values by varying scanning speeds for hard and soft tissue.

## Processing Time

On average, image processing is completed within just 20 seconds.

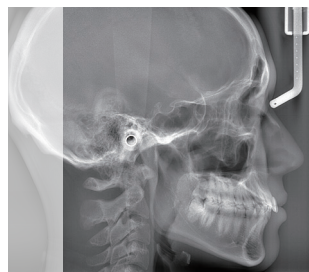
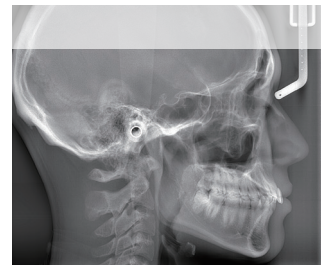
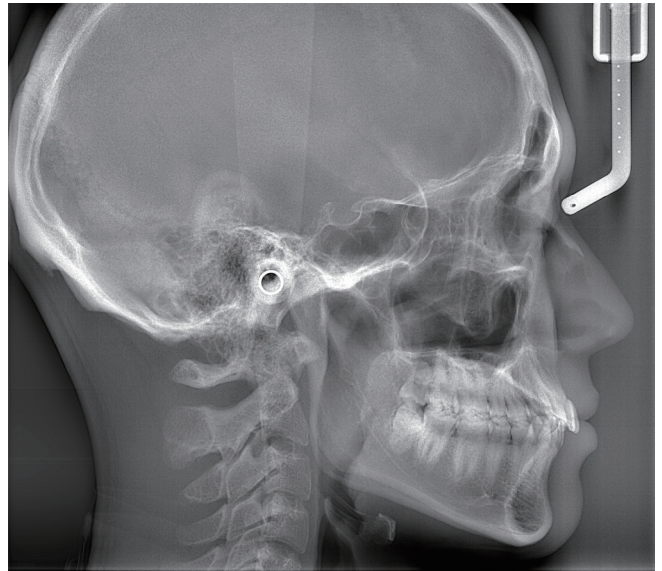

## Partial Cephalometric Images

If not needed for examination, X-ray dose can be reduced by eliminating the area behind the auditory canal. There are 3 partial image patterns.

\* Comparison made to Veraviewepocs film-based system

# Clinical Cases

## Implantology

The patient was seen for a routine follow-up visit following implant placement in the area of the left maxillary lateral incisor. The implant had been placed 3 months earlier. The coronal, sagittal, and axial planes revealed a large, round, well defined, non-corticated, low density area associated with the apical aspect of the implant. The high resolution images also shows absence of the buccal cortical plate confirming a poor prognosis for the case due to peri-implantitis.

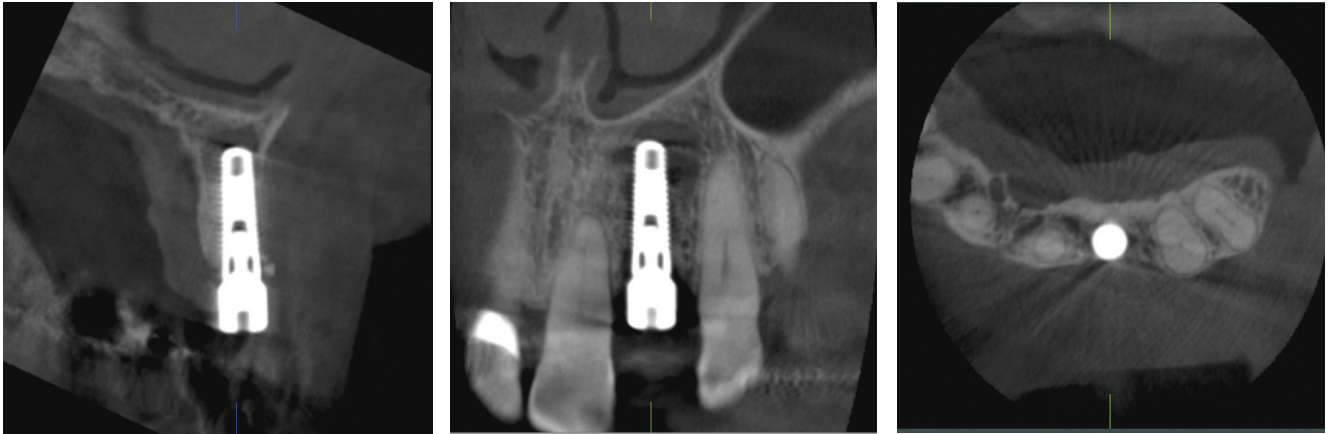

## Endodontics

The patient reported history of trauma in the left anterior maxilla. A cone beam CT volume of the maxilla was acquired with the 3D R100. The sagittal and axial views both showed a horizontal fracture associated with the buccal aspect of the cervical portion of the endodontically treated left lateral incisor. The sagittal plane also revealed perforation of the buccal cortical plate.

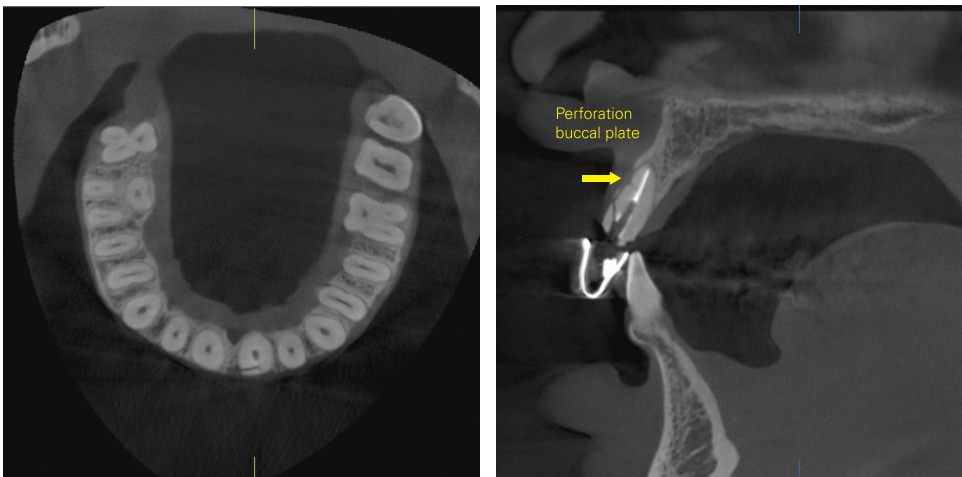

### Oral Surgery

Patient was referred for surgical removal of the mesial impacted right mandibular third molar. A cone beam CT volume was acquired with the 3D R100 to determine root-nerve proximity. The sagittal and coronal views revealed the path of the right inferior alveolar canal through the roots of the right mandibular third molar and thinning of the lingual cortical plate.

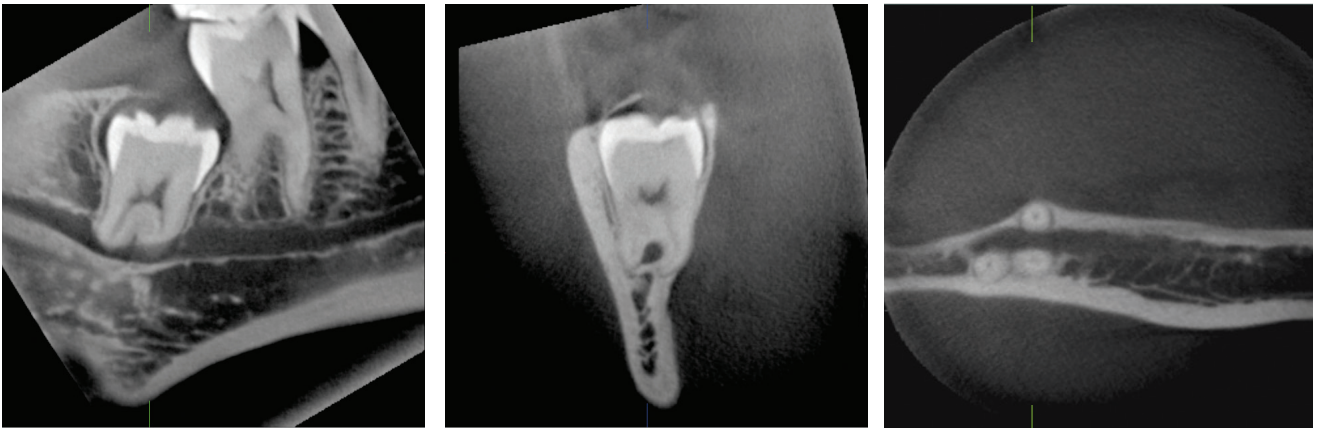

### Periodontics

The patient reported tooth sensitivity in the left maxillary second molar. A small volume cone beam CT of the left posterior maxilla was acquired with the 3D R100. The sagittal and coronal views showed severe vertical bone loss associated with the palatal root of the left maxillary second molar, along with mucosal thickening in the left maxillary sinus.

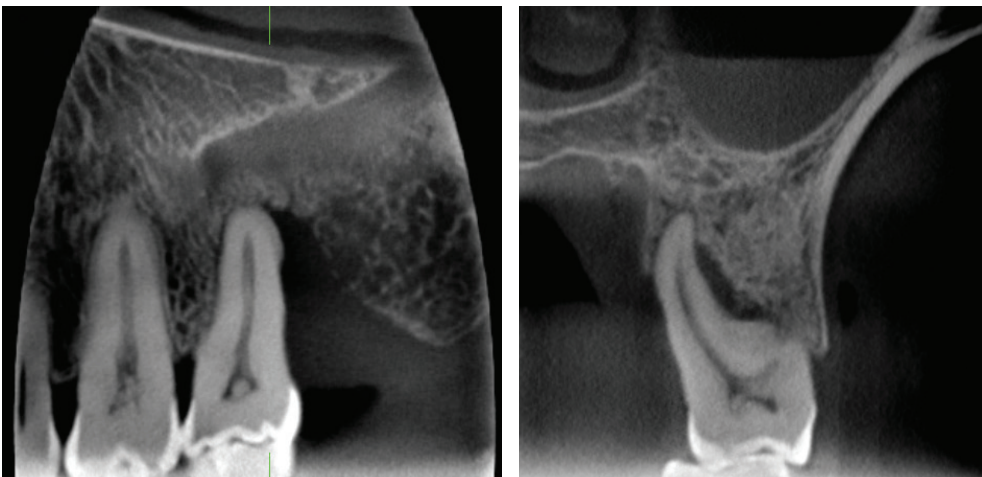

# Specifications

<b>Trade name:</b>	Veraviewepocs 3D
<b>Model:</b>	X550
<b>Type:</b>	EX-1, EX-2
<b>Unit configurations:</b> (EX-1, EX-2 available in all configurations)	Veraviewepocs 3D R100 Pan Veraviewepocs 3D R100 Pan/Ceph
<b>Input voltage:</b>	EX-1: AC 120V 60 Hz EX-2: AC 220/230/240V 50/60 Hz
<b>Power consumption:</b>	2.3 kVA
<b>Dimensions</b>	
<b>Main unit:</b>	W 40.15" x D 51.18" x H 92.72" (W 1,020 x D 1,300 x H 2,355 mm)
<b>With Cephalometric:</b>	W 78.74" x D 51.18" x H 92.72" (W 2,000 x D 1,300 x H 2,355 mm)
<b>Weight:</b>	Approx. 419 lbs. (Approx. 190 kg)  Approx. 573 lbs. with Cephalometric (Approx. 260 kg with Cephalometric)
<b>X-ray generator</b>	
<b>Tube voltage:</b>	60-90kV (depending on exposure mode)
<b>Tube current:</b>	1-10mA (depending on exposure mode)
<b>Effective focal spot:</b>	0.5 mm
<b>3D image</b>	
<b>Exposure time:</b>	Approx. 9.4 seconds
<b>Tube voltage and current:</b>	Normal mode 1 - 10mA (1mA step) @ 75 - 80 kV (5kV step) 1 - 8mA (1mA step) @ 85 - 90 kV (5kV step)  Dose reduction mode 3 - 10mA (1mA step) @ 75 - 80 kV (5kV step) 3 - 8mA (1mA step) @ 85 - 90 kV (5kV step)
<b>3D R100 imaging area:</b>	Ø 40 mm x H 40 mm Ø 40 mm x H 80 mm Ø 80 mm x H 50 mm Ø 80 mm x H 80 mm
<b>3D Reuleaux Full Arch FOV:</b>	Ø 100 mm (Equivalent) x H 50 mm Ø 100 mm (Equivalent) x H 80 mm

<b>Panoramic image</b>	
<b>Exposure time:</b>	High speed mode: Approx. 7.4 sec. (Standard) High definition mode: Approx. 15 sec.
<b>Imaging programs:</b>	Standard Panoramic (standard, orthogonal and shadow reduction projections) Magnification: 1.3 X throughout and 1.6 X throughout  Pedodontic Panoramic (standard, orthogonal and shadow reduction projections) Magnification: 1.3 X throughout and 1.6 X throughout  Maxillary Sinus Panoramic (posterior and anterior) Magnification: 1.5 X throughout  TMJ Quadruple Image Magnification: 1.3 X throughout  Partial Panoramic Magnification: 1.3 X throughout
<b>Cephalometric image (option)</b>	
<b>Projection:</b>	Posterior-anterior (PA) and Lateral (LA)
<b>Exposure time</b>	
<b>PA projection</b>	
<b>With variable imaging processing:</b>	4.1 seconds
<b>Without variable imaging processing:</b>	5.0 seconds
<b>Lateral projection</b>	
<b>With variable imaging processing:</b>	5.8 seconds, 4.2 seconds (partial ceph)
<b>Without variable imaging processing:</b>	3.5 seconds, 2.6 seconds (partial ceph)
	- Cephalometric is an optional feature. - The Veraviewepocs 3D must be fixed to the floor and the wall. - Always have patients wear X-ray protective gear.
	i-Dixel conforms to the following DICOM standards: 1. Modality worklist management service class 2. Storage service class 3. Modality performed procedure step service class 4. Print management service class

Clinical images provided by: Dr. Bruno Azevedo, Assistant Professor, University of Louisville School of Dentistry and Kitasenju Radist Dental Clinic, i-View Imaging Center, Japan.

# Machine Dimensions & Suggested Operating Space Requirements

## Panoramic

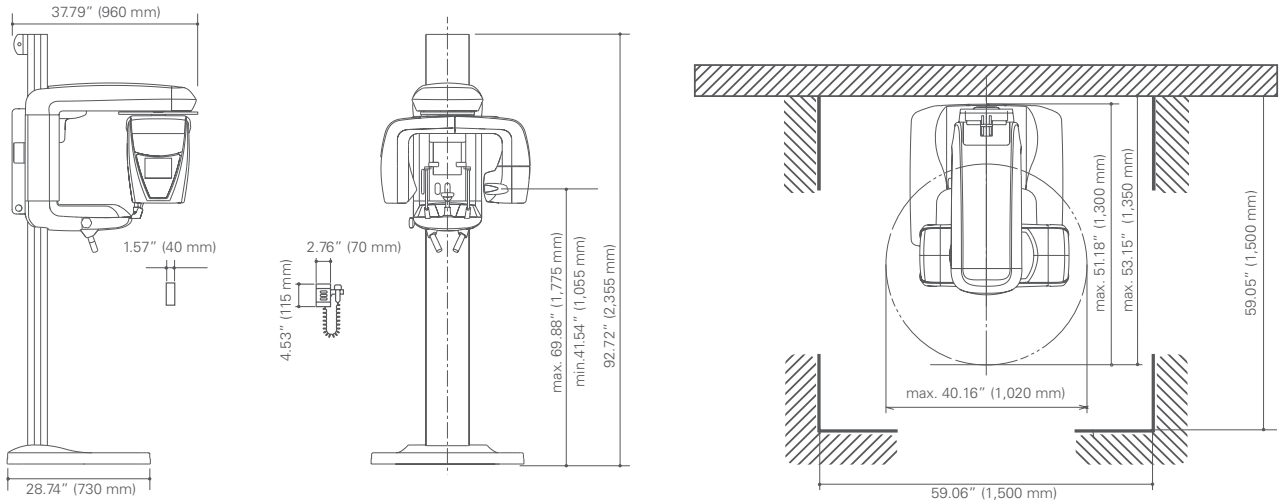

## Panoramic/Cephalometric:

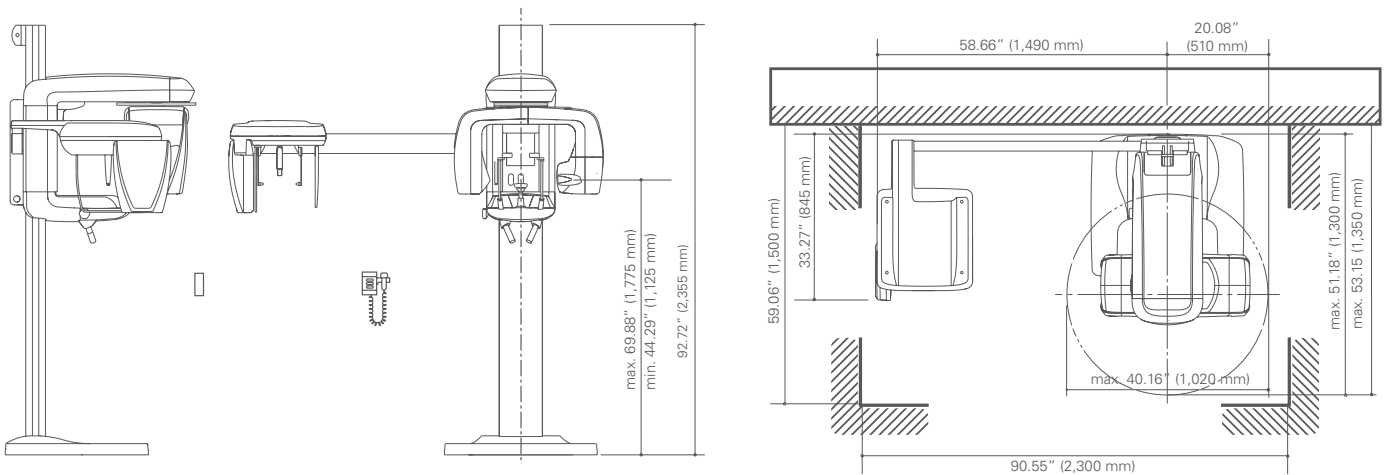



Development and Manufacturing

**J. MORITA MFG. CORP.**

680 Higashihama Minami-cho, Fushimi-ku,  
Kyoto 612-8533, Japan  
T +81. (0)75. 611 2141, F +81. (0)75. 622 4595

**Morita Global Website**

[www.morita.com](http://www.morita.com)

Distribution

**J. MORITA CORP.**

3-33-18 Tarumi-cho, Suita-shi, Osaka 564-8650, Japan  
T +81. (0)6. 6380 1521, F +81. (0)6. 6380 0585

**J. MORITA USA, INC.**

9 Mason, Irvine CA 92618, USA  
T +1. 949. 581 9600, F +1. 949. 581 8811

**J. MORITA EUROPE GMBH**

Justus-von-Liebig-Strasse 27a, 63128 Dietzenbach, Germany  
T +49. (0)6074. 836 0, F +49. (0)6074. 836 299

**MORITA DENTAL ASIA PTE. LTD.**

150 Kampong Ampat  
#06-01A KA Centre, Singapore 368324  
T +65. 6779. 4795, F +65. 6777. 2279

**J. MORITA CORP. AUSTRALIA & NEW ZEALAND**

Suite 2.05, 247 Coward Street, Mascot NSW 2020, Australia  
T +61. (0)2. 9667 3555, F +61. (0)2. 9667 3577

**J. MORITA CORP. MIDDLE EAST**

4 Tag Al Roasaa, Apartment 902, Saba Pacha 21311 Alexandria, Egypt  
T +20. (0)3. 58 222 94, F +20. (0)3. 58 222 96

**J. MORITA CORP. INDIA**

Filix Office No.908, L.B.S. Marg, Opp. Asian Paints, Bhandup (West), Mumbai 400078, India  
T +91-22-2595-3482

**J. MORITA MFG. CORP. INDONESIA**

28F, DBS Bank Tower, Jl. Prof. Dr. Satrio Kav. 3-5, Jakarta 12940, Indonesia  
T +62-21-2988-8332, F + 62-21-2988-8201

**SIAMDENT CO., LTD.**

71/10 Mu 5, Thakham, Bangpakong, Chachuengsao 24130, Thailand  
T +66. 38. 573042, F +66. 38. 573043  
[www.siamdent.com](http://www.siamdent.com)

Diagnostic and Imaging Equipment

Treatment Units

Handpieces and Instruments

Endodontic System

Laser Equipment

Laboratory Devices

Educational and Training Systems

Auxiliaries