

1 Preparation

Start i-Dixel or i-Dixel WEB software (hereinafter referred to as "i-Dixel WEB")

For a new patient: Register patient.

▶ See back of the Panorama Quick Guide.

For a patient already registered:

Enter the patient ID and click the Quick Search icon.

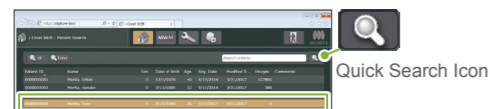

To use the patient list, double-click a patient.

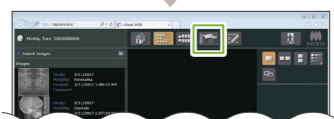

The patient's image list will appear. Click the X800 Exposure Window button to open it.

Turn On Power Switch

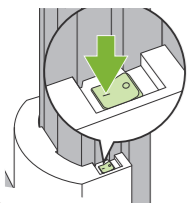

Press the Power switch (1).

A dialogue message saying "Initialization" will appear: touch the Ok button.

Set Exposure Conditions

Close the temporal stabilizers completely. Touch the Ceph key to select the cephalometric exposure mode. Set and check the exposure conditions.

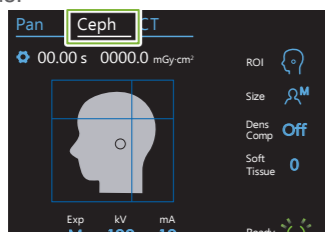

▶ See back of this page.

Touch Ready Key

Touch the Ready key. The X-ray head will turn to its cephalometric direction and the arm will automatically go to its cephalo exposure position.



Set Cephalo Head Positioner

Set the cephalo head positioner at the right angle for the exposure.

▶ See back of this page.

2 Patient Positioning

Prepare Patient

Take off glasses, necklaces, and other accessories.

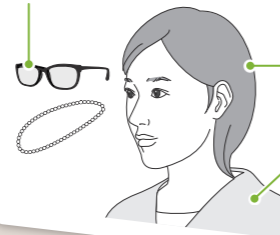

Undo hair tied up at the back of the head.

Have the patient put on an X-ray protection apron etc.

Adjust Height of Cephalo Unit

Adjust the height of the unit so that the ear rods are even with the patient's ear orifices.

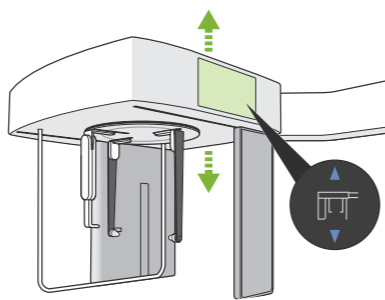

Patient Entry

Have the patient stand straight up directly under the head positioner.

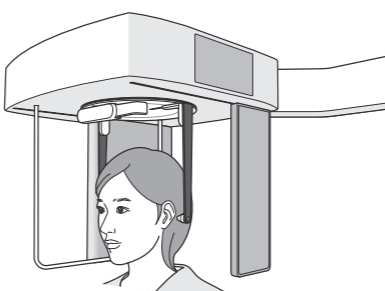

Insert Ear Rods

Tell the patient to:

! Tell the patient not to move until the exposure is finished.

PLEASE DON'T MOVE UNTIL I TELL YOU THE EXPOSURE IS FINISHED.

First put the ear rod in the right ear (A). Then carefully close the ear rod plates using both hands and carefully insert the left ear rod (B).

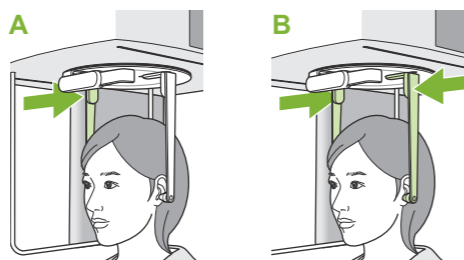

3 Positioning

Line Up Beam (for Lateral exposure only)

Press the Beam On/Off switch.

The X-ray detector will move and the horizontal beam will light up.

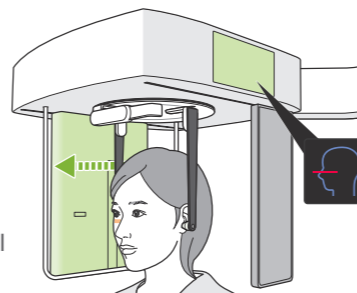

Position the patient.

Horizontal Beam ▶ Orbitale
Move the patient's head to line up the beam.

Look at the patient and make sure the mid-sagittal plane is perpendicular.

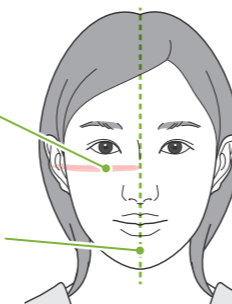

Adjust the height of the nasion plate and carefully put it against the patient's nasion.

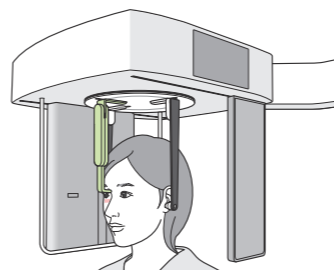

Press Exposure Start Position Switch

Press the Exposure Start Position switch. The X-ray detector and the cephalo slit will move to their start position and the unit will go into Ready state.

! Make sure that the cephalo slit does not contact the patient's shoulder.

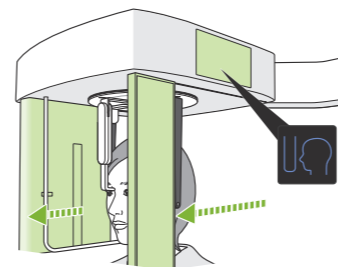

Leave X-ray Room

Tell the patient you are going to start the emission with a clear and sufficiently loud voice and then go out of a X-ray room.

I'M GOING TO START THE EXPOSURE.

PLEASE CLOSE YOUR EYES.

4 Exposure

Check Ready State



X-ray Emission

Hold down the Emission switch.

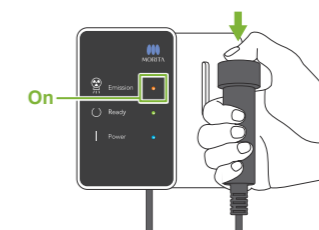

The exposure will begin in a few seconds. The cephalo slit will start moving. The Emission LED (yellow) on the control box will light up and the melody will sound.

Exposure Completed

The melody stops when the exposure has been completed. Release the Emission switch and hang it in its holder on the control box.



5 After Exposure

Patient Egress

For Lateral Exposure:
Pull the nasion plate out and then swing it up.

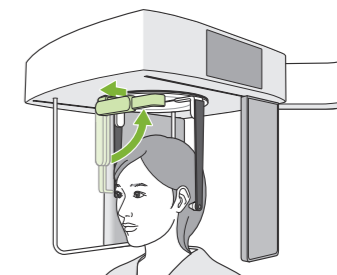

For PA and 45° Angle Exposures:
Press the In/Out switch to move the cephalo slit to the right edge.

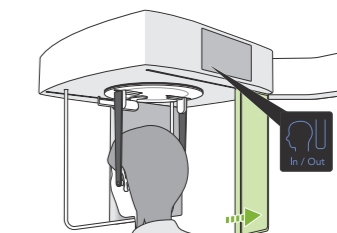

Remove Ear Rods

Remove the ear rods and Disinfect them.

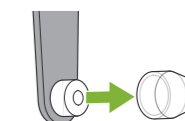
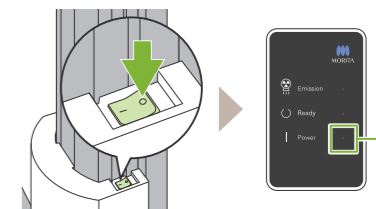

Image Transmission and Display

After the exposure, the data is sent to i-Dixel WEB. A message, "Transmitting Image" will appear in i-Dixel WEB. The image will be displayed after about 30 seconds.

! Do not turn off the Power switch until image transmission has been completed.

Turn Power Switch Off



Exposure Conditions

Blue icons and the Ready key are activated by touch.

1. Cephalo Mode Key
Exposure Time: 00.00s X-ray Dosage: 000.00mGy

2. Exposure Area (ROI)
3. Patient Size
4. Density Compensation
5. Density Compensation Start Position

6. Exposure Setting
7. Tube Voltage
8. Tube Current

Ready Key
Touch it before guiding the patient into position. The X-ray head will move into its cephalo position (ready state).

Density Compensation Start Position Illustration
Direction X-ray beam moves
Forwards Backwards

2. Exposure Area (ROI)	3. Patient Size (Size)	4. Density Compensation (Dens Comp)	5. Dens. Comp. Start Pos. (Soft Tissue) [mm]	6. Exposure Setting (Exp)	7. Tube Voltage (kV)	8. Tube Current (mA)
Lateral	C	On	10 5 0 -5 -10	M (manual exposure)	100	10
PA	S	Off			95	9
45° Angle	M			90	8	
Hand	L			85	7	
				80	6	
				75	5	
				70	4	
				65	3	
				60	2	

● Patient Size

The set values for patient size is the sagittal length of the skull (A).

Patient Size	C (Child)	S	M	L
Sagittal Length (A)	Max. 17 cm		Max. 19 cm	19 – 21 cm

* The above values are estimates only. The dentist should judge this by the patient's body shape, skeletal structure etc.



Cephalo Head Positioner

● Lateral Position

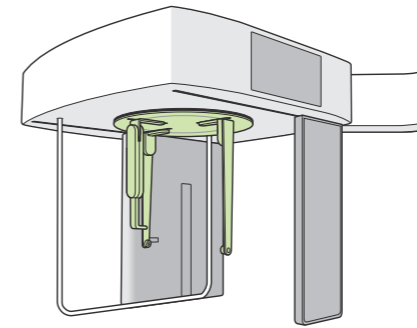

● PA Position

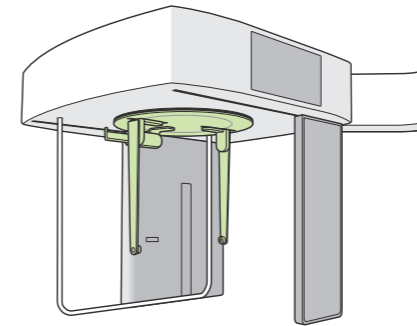

! Set the positioner as shown in the illustration above. Sliding the nasion plate out can cause an accident.

● 45° Angle Position

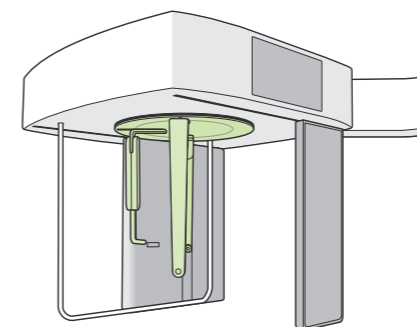

When rotating the head positioner, swing the nasion plate down and move it inside. Hold the ear rod plates at their bases and carefully rotate the head positioner.

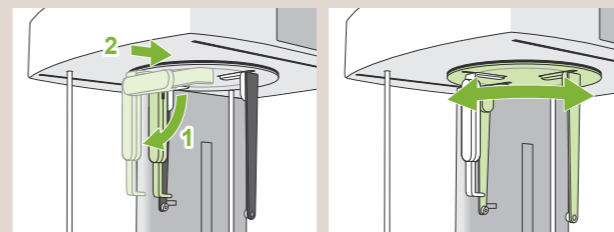

! Grab the nasion plate by its base to move it.