

Dental Treatment Unit

# Signo Z300

# Operation Instructions



Thank you very much for purchasing the Signo Z300.

Be sure to read these operation instructions completely and observe the method of use and precautions before use in order to fully utilize the functions of this equipment, to use it effectively, and to use it safely and without harm to people.

Read this operation instructions carefully before use. Keep the operation instructions close to this unit for future reference.

■ Trademarks and registered trademarks

The names of companies, products, services etc. listed in these operation instructions are the trademarks or registered trademarks of the respective company.

# Contents

■ Introduction	5
■ 1 Installation	7
1.1 Installation	7
1.2 Prerapation	7
1.3 Connection of Instruments	8
1.4 Installation of Filters	8
■ 2 Part Names	9
2.1 Chair	9
2.2 Panel	10
2.3 Foot Control	10
2.4 Accessories	11
■ 3 Actions Before and After Use	12
3.1 Preparation Before Use	12
3.1.1 Water/Air Supply and Main Switch	12
3.2 Interruption/Completion of Use	13
3.3 Storage	14

---

## ■ 4 Method of Operation 15

---

4.1 Precautions When Operating the Chair	16
4.1.1 Precautions When Operating the Chair	16
4.1.2 Safety Switch	16
4.2 Chair	17
4.2.1 Manual Chair Operation	17
4.2.2 Automatic Movement of Chair	18
4.2.3 Headrest Height and Angle Adjustment	20
4.3 Tray	21
4.3.1 Tray	21
4.4 Instrument Holder	22
4.4.1 Doctor-side Holder	22
4.4.2 Syringe Holder(Shoulder part)	23
4.5 Instruments	24
4.5.1 Water Supply Rate Adjustment	24
4.5.2 Water Tank	24
4.5.3 Foot Control Operation	25
4.5.4 Air Turbine Handpiece	27
4.5.5 Micromotor	28
4.5.6 Threeway Syringe	29
4.5.7 Vacuum Syringe	33
4.5.8 Warmer	35
4.6 Operating Light	36
4.6.1 Operation and removable range	36
4.6.2 Light ON and OFF	36

## ■ 5. Caring for the Unit 37

---

5.1 Autoclave Sterilization	37
5.1.1 Instrument Sterilization	38
5.1.2 Instrument Holder Sterilization	39
5.1.3 Other Sterilization	39
5.2 Wiping with Disinfectant Ethanol	40
5.2.1 Instrument Wiping	40
5.2.2 Wiping the Leather Seat	41
5.2.3 Wiping Other Parts	41

5.3 Other Cleaning Methods.....	42
5.4 Everyday Maintenance (before treatment).....	43
5.4.1 Flushing of Residual Water.....	43
5.5 Everyday Maintenance (after use).....	45
5.5.1 Cleaning the Vacuum Filter.....	45
5.5.2 Cleaning the Main Tube's Inner Side of Vacuum Syringe.....	45
5.6 Monthly Maintenance.....	46
5.6.1 Cleaning the Oil Collector.....	46
5.7 Annual Maintenance.....	47
5.7.1 Sterapore Cartridge Replacement.....	47
5.8 Maintenance as Required.....	51
5.8.1 Cleaning Other Parts.....	51
<b>■ 6 Maintenance and Inspection</b> .....	<b>52</b>
6.1 Replacement of Consumable Parts.....	52
6.1.1 List of Consumable Parts.....	53
6.1.2 Parts Replacement for Threeway Syringe.....	55
6.2 Daily Inspection by the User.....	56
6.2.1 Startup Inspection.....	56
6.2.2 Shutdown Inspection.....	56
6.3 Regular Maintenance Inspection.....	57
6.3.1 Maintenance and Inspection by the User.....	57
6.3.2 Outsourcing Maintenance and Inspection to a Contractor.....	58
6.4 After-sales Service and Contact Information.....	54
<b>■ 7 If Problems Arise</b> .....	<b>60</b>
7.1 Items to be Checked before Requesting Repair.....	60
7.2 Fuse .....	61
<b>■ 8 Warranty and Repair</b> .....	<b>62</b>
8.1 Warranty of this Product.....	62

8.2 Warranty Card.....	62
8.3 Repair.....	62
8.3.1 Before Requesting a Repair.....	62
8.3.2 Requesting a Repair.....	62
8.3.3 Spare Part Maintenance Period.....	62
<b>■ 9 Disposal of the Medical Device</b> .....	<b>63</b>
9.1 Disposal of This Product.....	63
<b>■ 10 General Information</b> .....	<b>64</b>
10.1 Specifications.....	64
10.2 Symbols.....	65
10.3 EMC Electromagnetic Compatibility.....	66

# Introduction

## Attention Customers

Please be sure to receive a full explanation of how to handle each item based on the operation instructions supplied with the product. After confirmation, fill in the Warranty Card with the clinic name and address and telephone number, sign it and hand over a copy to the dealer.

## Attention Dealers

After completion of installation, explain how to handle each item to the user based on these operation instructions in order to ensure safety.







After the explanation, ask the doctor to fill in the name of the clinic and address, telephone number, signature on the Warranty Card, then add your own name and hand the card to the doctor. A copy of the warranty card (manufacturing site copy) must be sent to J. MORITA TOKYO MFG. CORP.

## Preventing Accidents

Most operation and maintenance problems result from insufficient attention being paid to basic safety precautions and not being able to foresee the possibilities of accidents.

Problems and accidents are best avoided by foreseeing the possibility of danger and operating the unit in accordance with the manufacturer's recommendations. After carefully reading the warnings and precautions on each page, "Contraindications/Prohibitions" and "Precautions for Use (Safety and Hazard Prevention) of Electric Medical Devices", the equipment must be operated with the utmost caution to prevent either damaging the equipment itself or causing bodily injury.

**The degrees of harm or damage that may occur when this content is ignored and incorrect use occurs are categorized according to the following.**

List of Safety Symbols	
 <b>WARNING</b>	Indicates something that is expected to cause severe bodily injury (death/serious injury etc.) and damage to the equipment if handled incorrectly.
 <b>CAUTION</b>	Indicates something that is expected to cause minor injury and damage to the equipment if handled incorrectly.
	This symbol alerts the user to a warning/precaution.
	This symbol alerts the user to something that is prohibited.
	This symbol alerts the user to instructions and content which must be followed.
	This symbol alerts the user to pay attention to high temperature.
	This symbol alerts the user to a dangerous voltage.

The user (e.g., healthcare facility, clinic, hospital etc.) is responsible for the management, maintenance, and use of medical devices.

This equipment must only be used by dentists and other legally licensed professionals.

**Please do not use this equipment for purposes other than dental practice.**





## Disclaimer

- Please be aware that we cannot assume responsibility for the following (1)-(7).
  - (1) faults/injury resulting from repairs made by personnel not authorized by MORITA,
  - (2) any changes, modifications, or alterations to our products,
  - (3) faults/injury sustained by the use of products or equipment made by other manufacturers if not supplied by MORITA,
  - (4) faults/injury due to maintenance/repairs using spare parts other than genuine parts specified by MORITA,
  - (5) faults/injury due to failure to observe the precautions and follow the methods described in these operation instructions.
  - (6) faults/injury due to ambient conditions deviating from the conditions for use of this equipment such as the power supply and installation environment described in these operation instructions.
  - (7) faults/injury due to natural disasters such as fire, earthquake, flood, lightning etc.
- Attach the handpiece or syringe specified by us to the chair unit and do not use parts other than those specified by us. When attaching/connecting parts other than those specified by us, there is a danger that the part may become disconnected and fly out during use. Be aware that we cannot assume responsibility for faults in our products or injury or health problems if they arise under such circumstances.
- The working life (number of years of use) is 10 years (by self-certification) conditional upon regular maintenance and inspection being carried out after shipment.
- The working life for the safety and maintenance of each part is described in "Safety Note for Users of Dental Treatment Units (Issued by the Japan Dental Machine Manufacturers Association)" supplied with this device. Safety checks, checks on whether functionality has diminished and/or maintenance should be conducted before the end of the working life.
- Always ensure that a supply of tap water is connected to this equipment.





# 1 Installation



## 1.1 Installation

 <b>WARNING</b>	
	<p>Installation of this product should be carried out by a specialist technician (by MORITA CORP. or by a company designated by us).</p> <p>The installation must be in accordance with the supplied installation control standard.</p> <ul style="list-style-type: none"><li>● There is a danger of accidents and faults due to unforeseen circumstances.</li></ul>
	<p>Always ensure that this product is fixed to the floor using an appropriate method (stated in the supplied installation control standard).</p> <ul style="list-style-type: none"><li>● If not properly fixed, there is danger that the product will topple over and cause an accident and fault.</li></ul>
	<p>Do not use a power supply other than one of the stipulated power supply frequency [Hz], voltage [V], and permissible current [A] (or power consumption).</p> <p>Always ensure that a dedicated power supply circuit is provided for each unit and avoid sharing the power supply with other appliances and avoid a common/branching power supply.</p> <ul style="list-style-type: none"><li>● There is a danger of accidents and faults such as fire/electric shock etc.</li></ul>
	<p>Do not locate the unit where it is likely to get wet or in a location that gets wet.</p> <ul style="list-style-type: none"><li>● There is a danger that a short circuit or overheating may occur and cause a fault or accident such as fire/electric shock.</li></ul>
	<p>Do not install in a location where chemicals are stored or where gas is generated.</p> <ul style="list-style-type: none"><li>● There is a danger of accidents and faults such as fire/electric shock etc.</li></ul>
	<p>Do not position the power cord, ground wire, or foot control cable in a location where damage may easily occur (door, passageway etc.).</p> <ul style="list-style-type: none"><li>● There is a danger of accidents and faults such as a short circuit/electric shock etc.</li></ul>
 <b>CAUTION</b>	
	<p>Do not install the unit in an unstable location, such as on a slope or on a site subject to vibrations or impacts.</p> <ul style="list-style-type: none"><li>● This may cause a fault.</li></ul>
	<p>Do not install this unit in a location where there is a possibility of adverse effects occurring due to atmospheric pressure, temperature, ventilation, sunlight, dust, salinity, sulfur/ozone in the air etc.</p> <ul style="list-style-type: none"><li>● This may cause a fault.</li></ul>
	<p>Do not install this unit in the vicinity of equipment that generates electromagnetic waves such as communication equipment, elevators etc.</p> <ul style="list-style-type: none"><li>● This may cause a malfunction.</li></ul>
	<p>Keep it away from the heating system so that the hot air does not hit it directly.</p> <ul style="list-style-type: none"><li>● The heat causes the tube to soften and expand, causing breakage and other damage.</li></ul>
	<p>Do not install this unit in a location which does not meet the working environment conditions stipulated below.</p> <ul style="list-style-type: none"><li>① Temperature: 10-35°C</li><li>② RH: 30-75% (without condensation)</li><li>③ Air pressure: 700-1060 hPa</li></ul> <ul style="list-style-type: none"><li>● This may cause a fault.</li></ul>

## 1.2 Preparation

 <b>WARNING</b>	
	<p>Use tap water to supply the water line of the main unit.</p> <ul style="list-style-type: none"><li>● The use of cleansers, industrial water, unhygienic water etc. may damage the patient's health. Moreover, this may damage the pipes inside the main unit and may cause a fault.</li></ul>



## 1.3 Connection of Instruments

 CAUTION	
	Connect the main tube of each instrument before starting use. ● An inadequate connection may cause a water or air leak. If a connector is pushed at an angle or if it is forcibly turned and bent, there is a danger of damage.
	Keep each instrument in its holder when not in use. ● An accident/fault may occur due to unforeseen circumstances during operation of the vacuum equipment/instruments.

Connect the main tube to the tray, assistant-side holder, and unit, and put the instruments in their holders. Refer to the following.

- For each main tube connection ☞ Supplied installation control standard
- For the syringe case/nozzle of the threeway syringe connection ☞ pp. 29-32
- For the vacuum syringe ☞ p. 33
- For various instrument connections ☞ See the operation instructions supplied with each product

## 1.4 Installation of Filters

 CAUTION	
	Before commencing use, always ensure that filters are fitted to each part. ● Failure to install filters or improper installation may lead to a drop in performance, faults/pipe obstruction etc.

Each part is equipped with a filter to protect the inner parts from contamination and foreign matter. For how to install, refer to corresponding items in "5. Caring for the Unit" of these operation instructions.

1. Vacuum filter for vacuum pipeline
2. Sterapore cartridge (for water) Option
3. Sterapore cartridge (for air) Option

# 2 Part Names

## 2.1 Chair

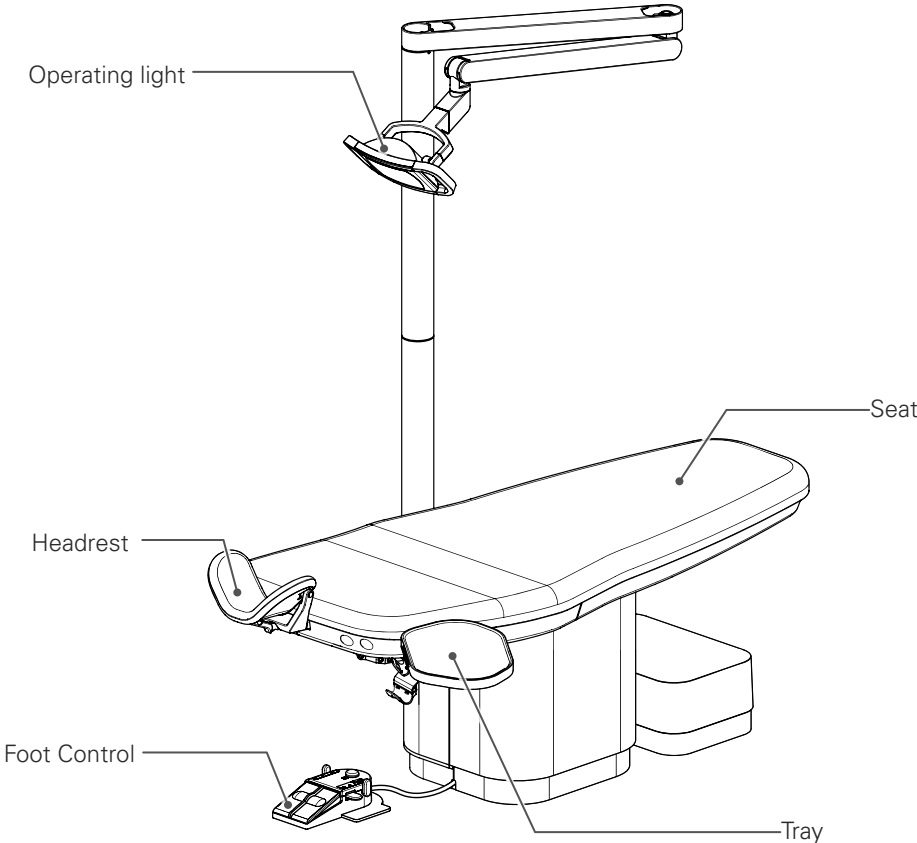

## 2.2 Panel

### ■ Display Panel

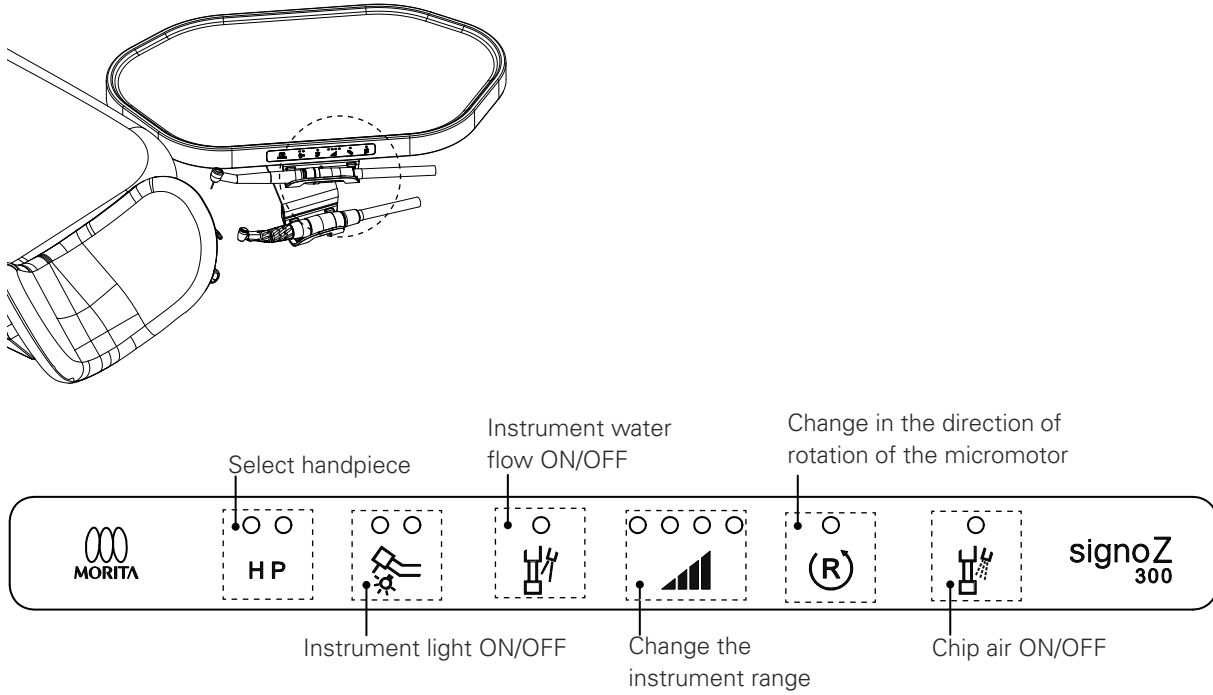

## 2.3 Foot Control

### ■ Name of Each Part

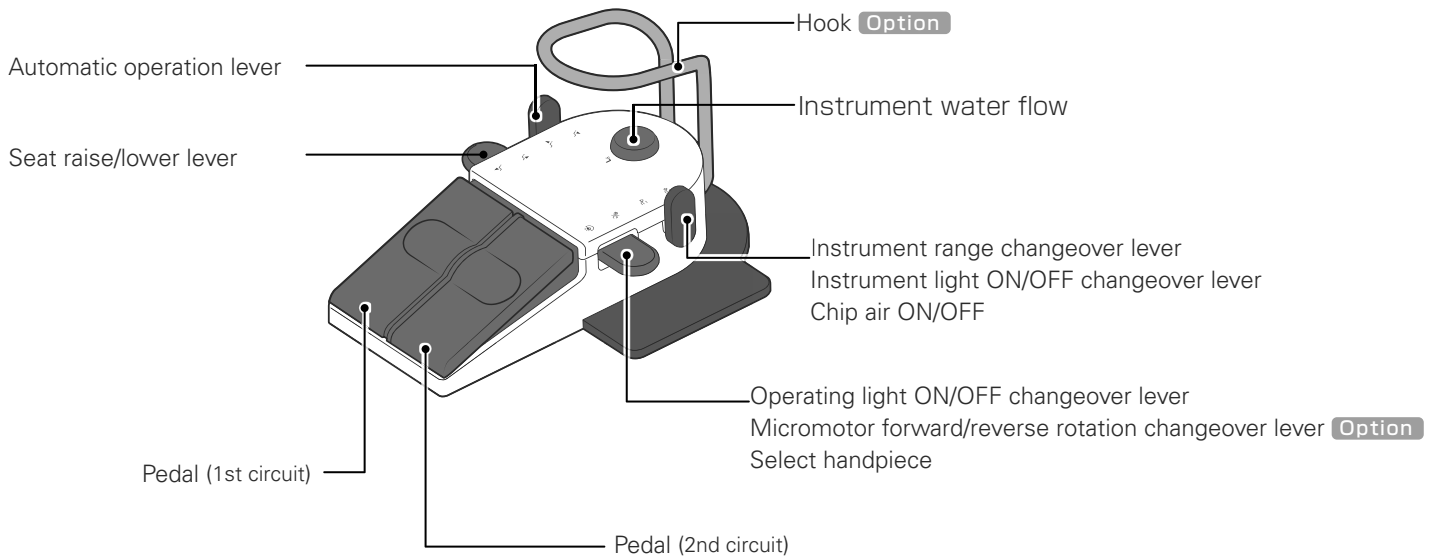

## 2.4 Accessories

Tray paper <b>Option</b>	1set
Spare fuse	1set
Dedicated cleaner for cleaning	1bottle
Air nozzle (for removing spray solution)	1
Operation instructions	1copy
Installation instructions	1copy
Warranty Card	1copy
Safety notes	1copy

Other accessories for each instrument are included.

# 3 Actions Before and After Use

Refer to the various operation instructions for details of handling the air turbine handpiece, micromotor handpiece, operating light etc. (separate volumes).

Use this unit in the following environment.

Temperature: 10-35°C, humidity: 30-75% RH (without condensation), air pressure: 700-1,060hPa

※ When using equipment that has not been used for a while, always be sure to check that the equipment operates normally and safely prior to use.

## 3.1 Preparation Before Use

### 3.1.1 Water/Air Supply and Main Switch

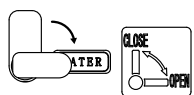

Water Supply Valve

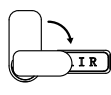

Air supply valve

#### 1 Open the water supply/air supply valves

Lower the water supply valve/air supply valve lever in the direction of the arrow and open the water supply/air circuits in the chair.

#### 2 Turn the power ON

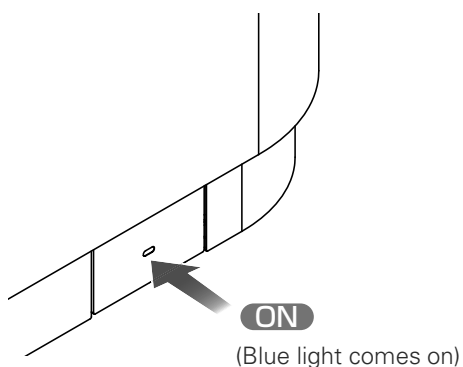





#### ⚠ CAUTION

	When power is ON, do not subject the main unit to impacts or vibration. ● Accidents and faults due to unforeseen circumstances may occur.
	When switching the power ON, check that the switches for operation of the device such as Up/Down, Upright/Reclining positions of the chair are not ON. ● The device may suddenly start to move and there is the risk of injury.

Press the main switch of the chair. The power comes ON.

## 3.2 Interruption/Completion of Use

 <b>WARNING</b>	
	Always turn the main switch OFF and close the water supply valve when treatment has been completed, when the device is not used for a long time, or when there is a malfunction/abnormality.
	<ul style="list-style-type: none"> <li>● Accidents and faults/problems such as fire due to a short circuit and water leakage may occur.</li> </ul>
	Ensure that all wiring, tubes etc. are connected when supplying power and water/air to the main unit.
	<ul style="list-style-type: none"> <li>● Failure to do so may result in accidents and faults due to a short circuit, heat generation, water leaks etc.</li> </ul>
	Do not expose the power supply to water or leave dust adhering to it.
	If there is a water leak, turn the main switch OFF, stop using the device, wipe away moisture and dry thoroughly before resuming use.
	If there is adhering dust, turn the main switch OFF and wipe dust off with a dry cloth etc.
	<ul style="list-style-type: none"> <li>● If use of the unit is continued while there is an abnormality, accidents and faults such as fire and electric shock due to a short circuit, heat generation etc. may occur.</li> </ul>

### ■ When use is interrupted, after completion of treatment

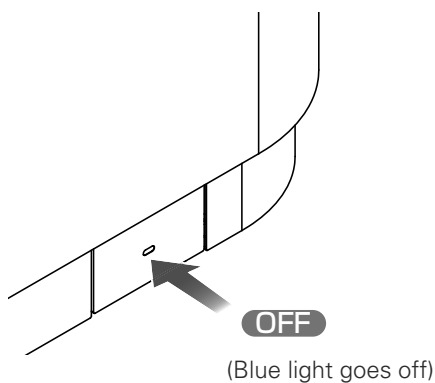

#### 1 Turn the power OFF

Press the main switch of the chair.  
The power goes OFF.

#### 2 Closing the Water Supply/Air Supply Valves

Raise the water supply valve/air supply valve lever in the direction of the arrow and close the water supply/air circuits to the chair.

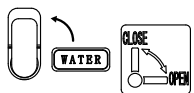

Water Supply  
Valve



Air supply valve

## ■ In Event of a Fault or Abnormality

If a fault or an abnormality occurs, always be sure to turn the main switch OFF and shut off the water and air supplies.

- When the water supply does not stop such as with the failure of an automatic filler
- When replacing the sterapore cartridge
- When a localized water leak is detected
- When there is a failure/repair request
- When there is a disaster such as an earthquake

## 3.3 Storage





Observe the following storage/transportation conditions when storing/transporting the main unit.

- ① Temperature: -10-70°C
  - ② Humidity: 10-85% RH (without condensation)
  - ③ Air pressure: 700-1,060hPa
  - ④ Do not install the unit in an unstable location, such as on a slope or on a site subject to vibrations or impacts.
  - ⑤ Do not install this unit at a site where there is a possibility of adverse effects occurring due to atmospheric pressure, temperature, ventilation, sunlight, dust, salinity, sulfur/ozone in the air etc.
- Failure to comply may cause a fault.



## 4 Method of Operation

### WARNING

	<p>Do not place objects or bring fingers, feet, or footwear near to movable parts such as the seat and backrest hinge of the main unit. (refer to the List of Precautions)</p> <ul style="list-style-type: none"> <li>● There is a risk that items will be caught during operation and accidents such as injury and damage/faults may occur.</li> </ul>
	<p>Do not place heavy objects on the edges of the seat/backrest/headrest or on the light/tray etc. and do not apply excessive forces to these areas. Avoid behavior such as standing/jumping on the main unit.</p> <ul style="list-style-type: none"> <li>● There is a danger of the main unit toppling over or incurring damage and causing an accident or fault.</li> </ul>
	<p>Do not spill liquid inside the main unit and do not insert easily combustible items and metals.</p> <ul style="list-style-type: none"> <li>● If the unit continues to be used as is, there is a danger of accidents and faults such as fire/electric shock etc.</li> </ul>
	<p>Do not place a heat source such as a heater near the main unit.</p> <ul style="list-style-type: none"> <li>● There is a risk of deformation and damage to the main unit and rupture of the piping due to residual air pressure.</li> </ul>
	<p>Observe the following points during operation of the main unit and refer to the “List of Precautions” in the next section to ensure safety.</p> <ol style="list-style-type: none"> <li>① Apart from doctors and assistants, no-one should operate the main body without permission (as a mischievous prank etc.)</li> <li>② Keep an eye on patients (especially infants and the elderly)</li> <li>③ Do not allow patients to adopt a dangerous posture (put their legs on either side of the seat, stand on the seat, kneel on the seat, sit while wearing footwear such as heels and slippers etc.)</li> <li>④ Do not let movement/posture exert a heavy burden on patients (such as a sudden headrest operation for patients with a cervical vertebrae disorder or adopt a supine posture while suffering back pain etc.)</li> <li>⑤ Do not allow hands, parts of the body/belongings etc. to come close to the movable parts of the main unit and vicinity (do not allow the patient to grasp the tray arm, place hands at the base of the backrest, sit with a phone in their pocket, etc.)</li> <li>⑥ Do not allow more than one patient on the seat (holding a child etc.)</li> <li>⑦ Do not let anyone unrelated to treatment enter the surrounding area (such as a child approaching/touching the unit)</li> <li>⑧ Do not move the small tray etc. close to the surrounding walls/windows/equipment/appliances etc. (collision may occur during operation etc.)</li> <li>⑨ Do not behave in a way considered to be dangerous</li> <li>⑩ Do not operate the chair in a situation that is considered to be dangerous</li> </ol> <ul style="list-style-type: none"> <li>● There is a danger of accidents causing injury etc., damage/faults occurring.</li> </ul>
	<p>If there is a risk of injury or a collision during automatic operation of the main unit, carry out the following stop procedures immediately.</p> <ol style="list-style-type: none"> <li>(A) Step on the foot pedal</li> <li>(B) Operate the manual operation lever (either up, down, upright, or reclined)</li> <li>(C) Turn the main switch OFF</li> </ol> <ul style="list-style-type: none"> <li>● There is a danger of accidents causing injury etc., damage/faults occurring.</li> </ul>
<h3> CAUTION</h3>	
	<p>If a patient uses a pacemaker, do not simultaneously use the ultrasonic scaler, electrocautery scalpel and root canal length measuring instrument.</p> <ul style="list-style-type: none"> <li>● The pacemaker may malfunction and damage the patient's health.</li> </ul>
	<p>Always be sure to turn the main switch OFF when using an electrocautery scalpel near and around the main unit. Refrain from using devices generating electromagnetic waves such as cell phones etc.</p> <ul style="list-style-type: none"> <li>● Malfunctions arise due to electromagnetic waves and an accident/fault may occur due to unforeseen circumstances.</li> </ul>

## 4.1 Precautions When Operating the Chair

Always carry out a safety check before operating the chair (automatic/manual). In particular, take care to avoid touching or pinching the patient and surrounding instruments etc. by following the precautions shown in the figure below.

### 4.1.1 Precautions When Operating the Chair

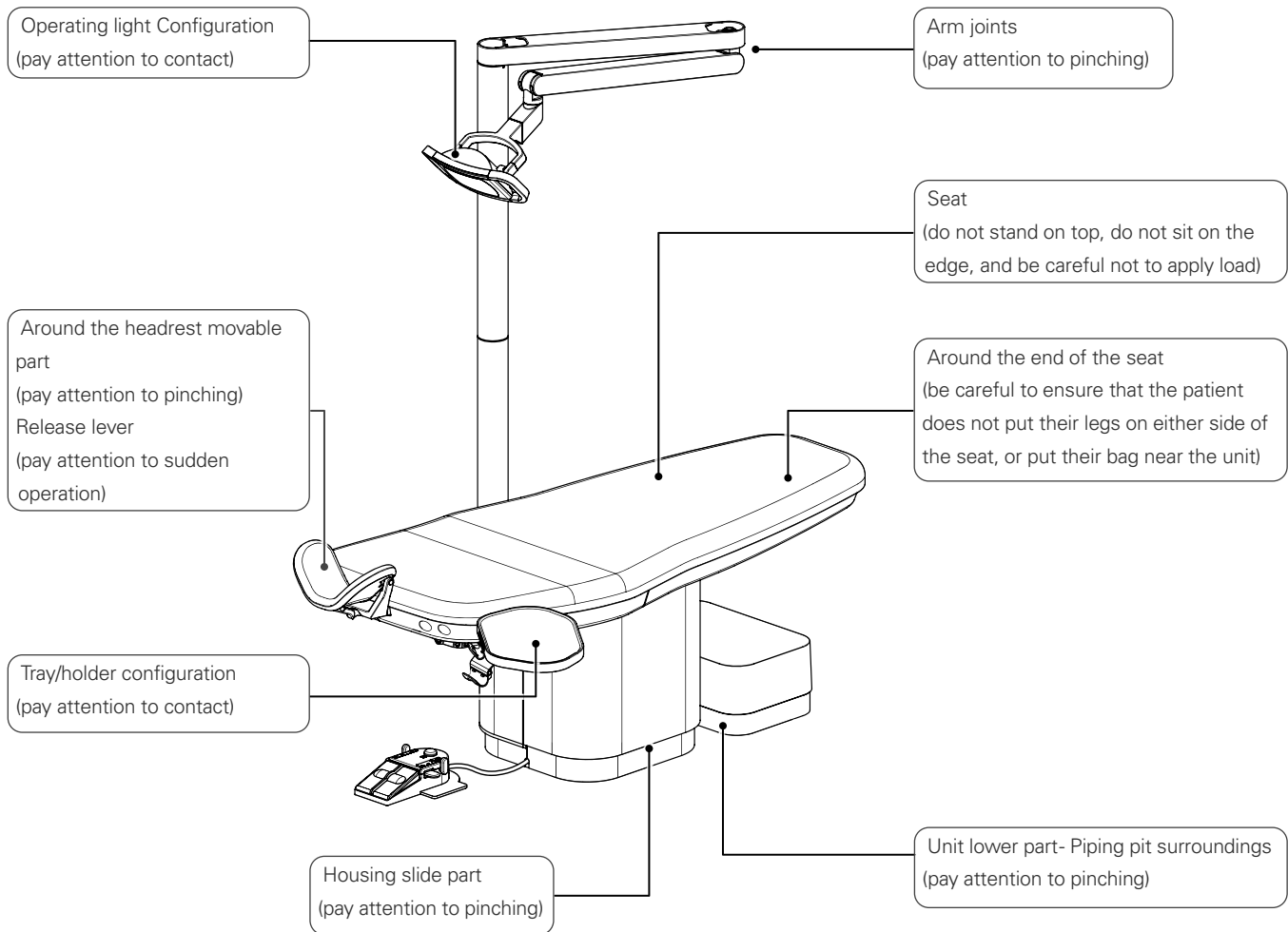

### 4.1.2 Safety Switch

#### ■ Automatic Shutdown Using the Safety Switch

If any of the following situations arise during automatic operation, the safety switch is activated and the system stops automatically.

Check the relevant part, remove the obstruction then resume use.

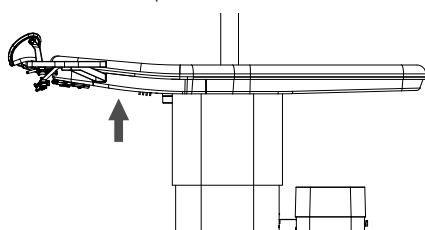

While descending, the seat rises up.

## 4.2 Chair

### 4.2.1 Manual Chair Operation

#### ■ Raising and lowering the chair

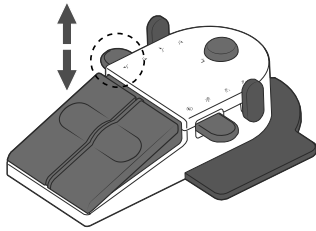

Raise and lower the chair using the manual operation switches on the foot control.  
Chair operation is possible during this process.

## 4.2.2 Automatic Movement of chair

### WARNING



Do not leave the seat when in operation and make sure that the patient is in the correct posture.

- There is the risk of accident such as injury.

### ■ Reset

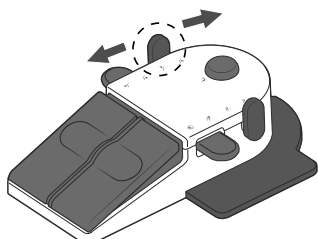

#### Foot control operations

Operate the lever in the direction of the arrow, push and hold for 2 seconds more.

### ■ Interrupting Automatic Operation

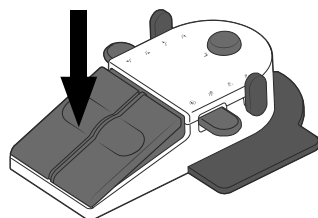

#### Manual Interruption of Automatic Operation

To stop automatic operation, perform one of the following operations.

- Step on the foot control pedal.
- Turn the main switch OFF.

## ■ Chair Lock Switch



Press the chair lock switch if you want to disable the functions of the chair.  
(the light on the switch is lit while the chair is locked)

Instruments can be used.

Press the switch again to cancel operation.

NOTE: The chair will not operate even if the switches of the foot control, the chair position automatic switches, or the raise/lower switches are used.

### 4.2.3 Headrest Height and Angle Adjustment

<b>⚠ WARNING</b>	
⊘	<p>Do not put your fingers, hair, clothing etc. close to moving parts such as the headrest movable parts/slide bar.</p> <ul style="list-style-type: none"> <li>● Accidents due to pinching and jamming etc. may occur.</li> </ul>
⊘	<p>Do not adjust the angle of the headrest while a patient is seated.</p> <ul style="list-style-type: none"> <li>● There is a risk of injury to the patient's neck/head due to sudden operation and the risk of damage/faults to the shaft part due to loads.</li> </ul>
!	<p>Any angle adjustment of the headrest should be carried out by the doctor.</p> <p>Do not allow an assistant or a patient to touch the release button or the release lever when the headrest is in an unsupported position.</p> <ul style="list-style-type: none"> <li>● This could result in a sudden drop or movement of the headrest, resulting in injury or causing an accident, damage or fault.</li> </ul>
!	<p>When adjusting the angle of the headrest or shortening the slide bar, always move the headrest slowly while supporting it with your other hand. Check that it is securely fixed after adjustment.</p> <ul style="list-style-type: none"> <li>● The headrest may drop suddenly and accidents such as injury and damage/faults may occur. There is the risk that sudden movement may hurt the patient's neck/head.</li> </ul>

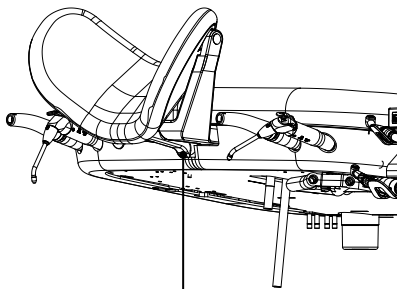

Adjustment rod

Angle of maxillary occlusal plane with respect to floor

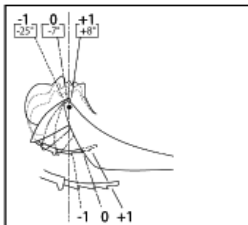

#### Angle adjustment

Adjust headrest's angle with your arm.

3 steps can be set.

To make the headrest up: Slide the adjustment rod upwards by supporting it with your arm.

To make the headrest down: Slide the adjustment rod downwards by supporting it and raising it lightly with your arm.

#### Treatment position

0: For doctors with the most appropriate treatment condition, use this position to conduct all your treatment except the treatment below.

+1: For mandibular lingual treatment, and M.O.D treatment of mandibular first molar.

-1: For maxillary oral surgery, and crown placement of maxillary occlusal plane.

note: If you want to conduct a treatment with your direct view, -1 position will be used in most of maxillary treatment.

## 4.3 Tray

### ⚠ WARNING



Do not apply a load of 20 N (2 kgf) or more to the tray.  
 Do not subject the tray to excessive loads or impacts.  
 ● If the load exceeds 20 N, the tray may drop and an accident or damage/fault may occur.

### 4.3.1 Tray

#### ■ Tray

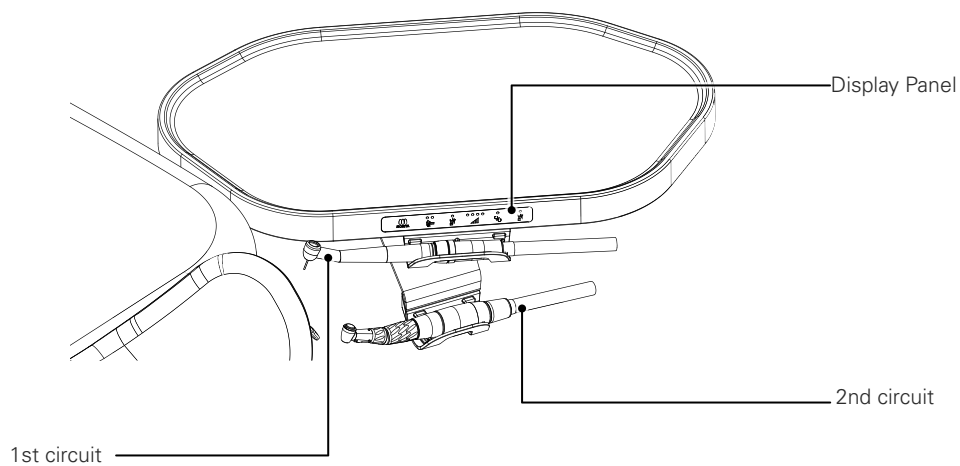

#### ■ Left- or right-handed operation Option

The tray and tube guides can be swapped over to allow left- or right-handed operation.

#### ■ Silicone tray sheet Option

Use by laying on the tray.  
 Autoclave and ethanol cleaning may be used.

## 4.4 Instrument Holder

<b>⚠ CAUTION</b>	
<b>!</b>	<p>Always be sure to return all the handpieces to instrument holder before conducting an operation of chair movement.</p> <ul style="list-style-type: none"> <li>● If handpieces drop from instrument holders it may cause damages/faults.</li> </ul>
<b>⊘</b>	<p>Do not apply a load to the main tube (by pulling the tray by the main tube or by forcefully pulling the tube when wiping it).</p> <ul style="list-style-type: none"> <li>● This may cause air leaks/water leaks and damage/faults.</li> </ul>
	<p>Do not place any heat source such as heater around the main tubes.</p> <ul style="list-style-type: none"> <li>● This may lead to rupture of the main tube.</li> </ul>
	<p>Do not forcefully pull or remove the main tube, roller, or holder.</p> <ul style="list-style-type: none"> <li>● Not following the correct procedure may result in damage or a fault.</li> </ul>

### 4.4.1 Doctor-side Holder

Instrument Holder

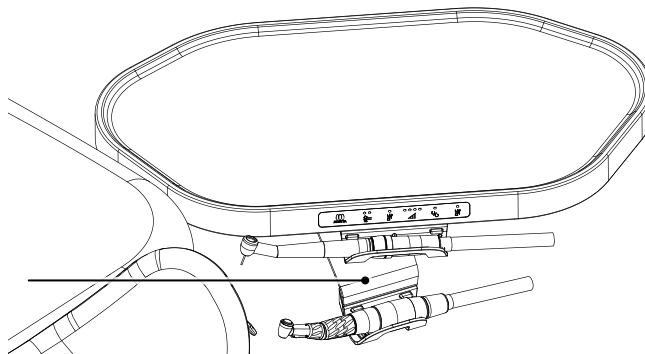



### 4.4.2 Syringe Holder (Shoulder part)

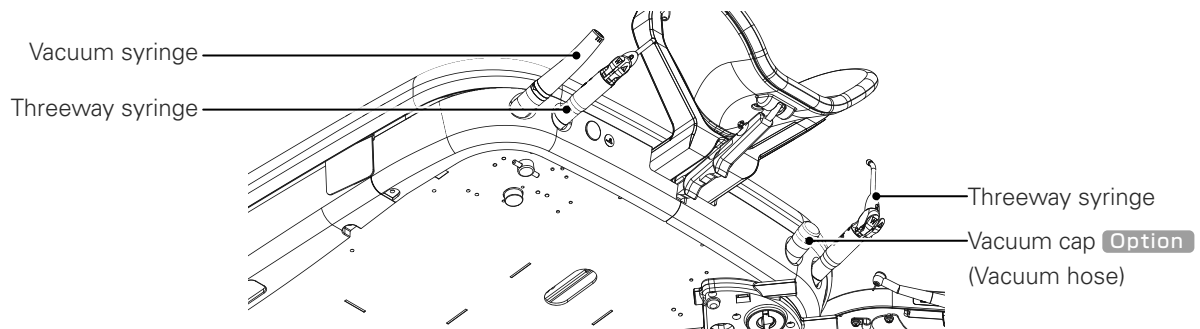

Fix the tube: Keep pulling out the threeway or vacuum syringe until the tube is fixed by stopper.

note: For right-handed fixed, there is no stopper on the threeway syringe on the Doctor side.

Return the tube: Pull the fixed tube lightly, then return it back.

## 4.5 Instruments

<b>⚠ WARNING</b>	
	For how to connect and use the air turbine, micromotor, ultrasonic scaler etc., always follow the operation instructions supplied with the relevant product. ● Improper handling may cause accidents and faults due to unforeseen circumstances.
<b>!</b>	When putting instruments into the holders, do so gently and carefully. If an instrument is not put back securely, it may not be selected correctly. ● This may cause accidents/problems and faults.
	If significant expansion occurs in the main tube while the air turbine is being used, immediately stop using it and check the state of the exhaust. ● If the exhaust tube ruptures or clogs, continued use may lead to expansion and rupture of the main tube, and an accident/fault may occur.
	Be sure the handpiece bar has stopped rotating before putting the handpiece into the patient's mouth. ● There is the risk of injury.
<b>⊘</b>	Do not bend the main tube while using instruments, especially when using the air turbine. ● If you continue use it while bent . This may lead to expansion and rupture of the main tube, causing an accident/fault.
<b>⚠ CAUTION</b>	
<b>!</b>	Pay careful attention when jetting air onto the gums of the patient, and promptly take appropriate action if an abnormality occurs. ● When air is used on the gingiva, complications such subcutaneous emphysema can occur.
	Keep it away from the heating system so that the hot air does not hit it directly. >>The heat causes the tube to soften and expand, causing breakage and other damage.

### 4.5.1 Water Supply Rate Adjustment

The instrument water supply rate can be adjusted.

#### ■ Doctor-side Instruments

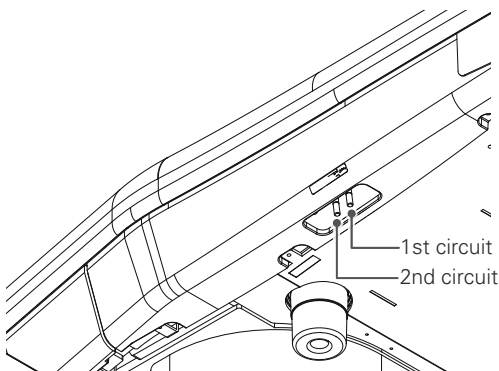

Adjust using the valve.  
Increase the water flow rate.

### 4.5.2 Water Tank Option



Water for each instrument's water injection is supplied from the water tank attached to the light pole.  
For the usage of the water tank, please operate according to the attached instruction manual.

### 4.5.3 Foot Control Operation

The foot control with extended functions enables you to perform the following operations while holding an instrument.

#### ■ Display of select handpiece's circuit

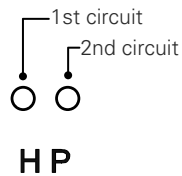
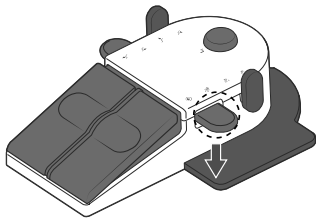

Operate the lever in the direction of the arrow, push back and hold 2 seconds more.

The light of showing each active handpiece's circuit in display panel can be changed.

If you turn on the power, the active circuit become to the 1st circuit automatically.

#### ■ Instrument light ON/OFF

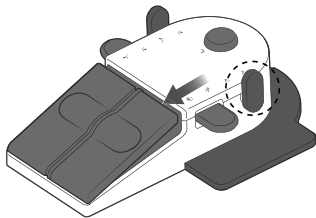

Operate the lever in the direction of the arrow, push back and hold 2 seconds more. (The operation the foot control is OFF → L → H → OFF.)

Switches instrument light ON/OFF.

Brightness can be adjusted to 2 levels.

Both are off : OFF

Left on : L

Both are on : H

#### ■ Switching water flow

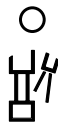
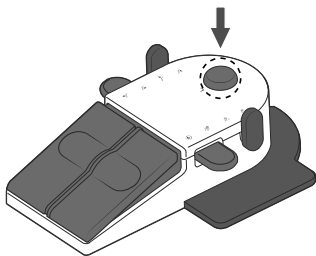

Operate the lever in the direction of the arrow.

Switches instrument water flow ON/OFF.

#### ■ Switching Range Option

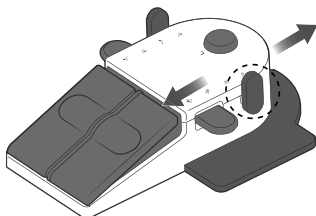

Operate the lever in the direction of the arrow.

Instrument range (UL, L, M, H) switchover.

● Micromotor

#### ■ Switching rotation direction Option

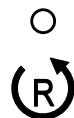
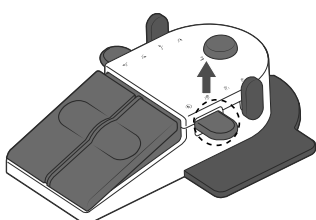

Operate the lever in the direction of the arrow.

Changes the direction of rotation of the micromotor.

## ■ Chip air ON/OFF

Chip air ON/OFF can be set.  
Can be set for each range.

The micromotor may become hot if chip air continues to be used while it is OFF. Usually use chip air while ON.

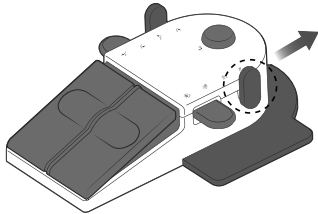

Operate the lever in the direction of the arrow, push forward and hold 2 seconds.

Chip air ON/OFF can be changed using the footcontrol lever.

## 4.5.4 Air Turbine Handpiece

### ⚠ CAUTION



When using the air turbine handpiece, always pick up the handpiece and operate the foot control.  
 ● If handpieces drop from instrument holders, it may cause damages/faults.

For details of how to handle the air turbine handpiece, always read the separate operation instructions.

### ■ Starting and Stopping Rotation

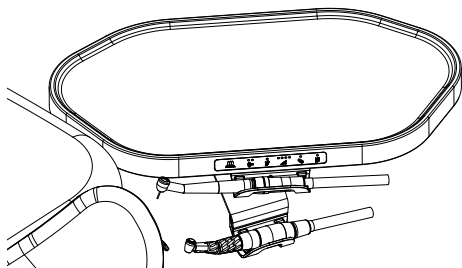

① Pick up the air turbine handpiece from the instrument holder.

② The rotation speed varies depending on how far the foot control pedal is pressed. And release the pedal to stop.

Seat operation is not possible while the micrometer is running.

### ■ Clean air system Option

Prevents the suction effect that occurs when rotation of the air turbine stops, and prevents ingress of cutting debris, soiled waste etc. into the air circuit.

Expels a small amount of air for about 10 seconds when the air turbine stops.

### ■ Various Settings



Various settings and changes can be made.

For settings, refer to the following sections.

● Switching water flow ON/OFF ☞ p. 25

● Switching the light ON/OFF ☞ p. 25

### 4.5.5 Micromotor Option

 CAUTION	
	When using the air turbine handpiece, always pick up the handpiece and operate the foot control. ● If handpieces drop from instrument holders, it may cause damages/faults.
	Do not apply repeated sudden loads or lock the micromotor while it is rotating. ● The micromotor may overheat and cause a fault.

For details of how to handle the micromotor, be sure to read the separate operation instructions.

#### ■ Starting and Stopping Rotation

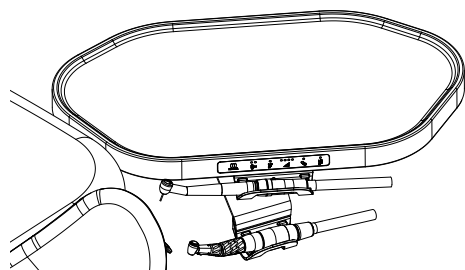

① Pick up the micromotor from the instrument holder.

② Step on the foot control pedal to start the micromotor and release the pedal to stop.

Seat operation is not possible while the micrometer is running.

#### ■ Setting the Rotation Speed

You can switch between 4 ranges (UL, L, M, H) using the range changeover switch and further adjust the speed within each range.

The rotation speed varies depending on how far the foot control pedal is pressed.

The available variable speeds are as follows.

Range	Rotation speed (min <sup>-1</sup> )
UL	100 ~ 250
L	100 ~ 3,000
M	100 ~ 9,000
H	100 ~ 40,000

#### ■ Various Settings

Various settings and changes can be made.

For settings, refer to the following sections.

- Switching water flow ON/OFF ☞ p. 25
- Switching the light ON/OFF ☞ p. 25
- Switching rotation direction ☞ p. 25
- Range changeover ☞ p. 25

## 4.5.6 Threeway Syringe

### ⚠ WARNING



When using hot water, be sure to check that the temperature is correct before use.

- The temperature of the warmer may rise considerably due to overheating or the effects of external air temperature and accidents such as scalding and damage/faults may occur.

### ⚠ CAUTION



If hot water is not needed, turn the warmer switch OFF.

- Overheating of the heater may shorten the life of the tube or heater and lead to damage and faults.

Keep heaters such as fan heaters and oil heaters close to each other, or make sure that warm air does not hit them directly.

- Heat softens and expands the tube, causing breakage or other damage.

### ■ WS201

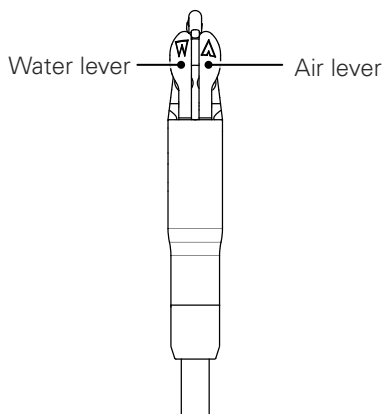

### Operation

When the water lever and air lever are operated, water, air and spray will be released.

A little water may come out of the threeway syringe when the air lever is pressed right after the nozzle has been attached. Press the air lever 2 or 3 times to expel all the water.

Water lever: emits water.

Air lever: emits air.

Water and air levers pressed together: emits a spray.

### Attaching the nozzle and syringe body

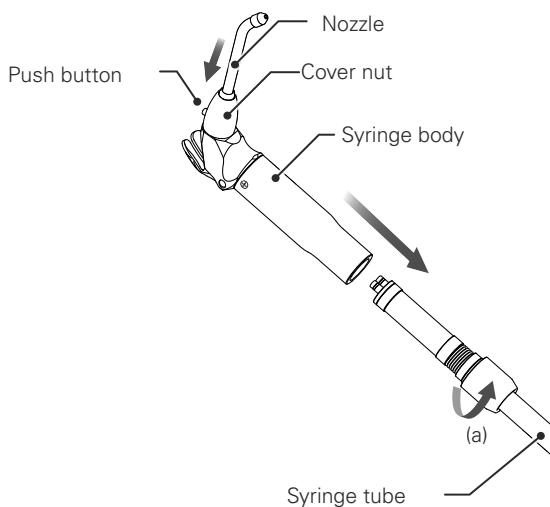

Push the syringe into main tube as the figure, and turn the connector in the direction of the arrow(a) to connect them.

Insert the nozzle into the inner part of syringe body straightly by holding the cover nut, while pressing the push button.

Connect the syringe body to the syringe tube securely. It may unexpectedly pop out if it is not connected securely.

Connect the nozzle to the syringe body securely.

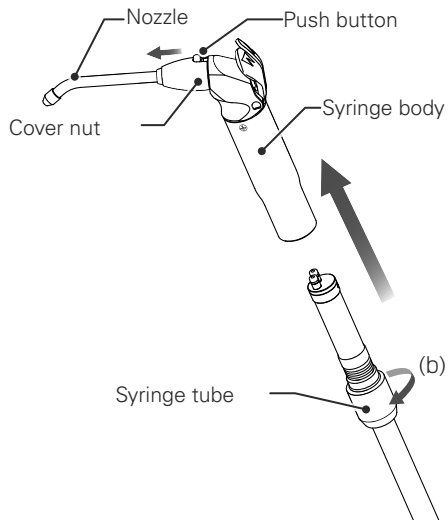

**Removing the nozzle and syringe body**

Remove the nozzle from the syringe straightly by holding the cover nut, while pressing the push button.  
When removing the syringe body, turn the syringe body in the direction of the arrow(b) to remove it.

**WS12N/WS10-O-LD** Option

WS12N

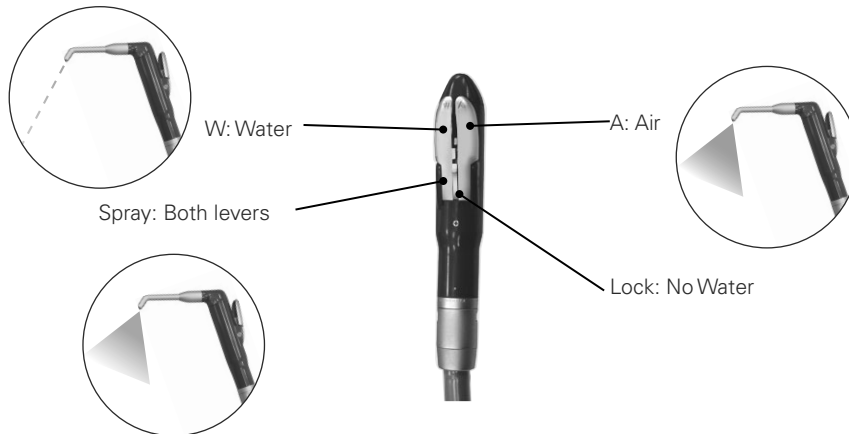

WS10-O-LD

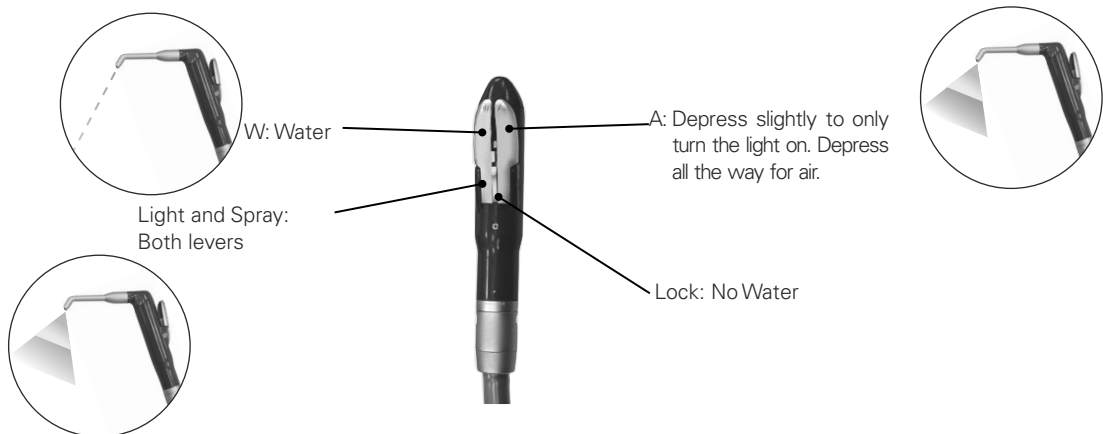

\*Always lock the water lever before putting the syringe away to prevent leaking.



**⚠ CAUTION**

<b>!</b>	Make sure there is an audible click when putting the nozzle on the threeway syringe and that the nozzle is securely fixed to the syringe.
	Remember that the LED and its cover are extremely hot right after the LED has been turned off . Do not touch these parts; they could cause a burn.
	Make sure the threeway syringe case and body are securely attached to each other. Otherwise, the case could slip off when you take it out of its holder.
	If the nozzle gets plugged up with debris, it could be blown off the end of the syringe during use and injure someone.

WS12N

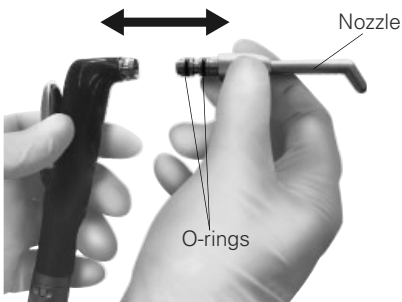

**Removing and inserting the nozzle**

Push the nozzle into the syringe or pull it out.

A little water may come out of the threeway syringe when the air lever is pressed right after the nozzle has been attached. Press the air lever 2 or 3 times to expel all the water.

Coat the nozzle's O-rings with vaseline if it is hard to attach and remove.

WS10-O-LD

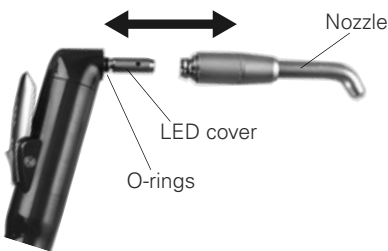

**Putting On the Syringe Case**

Match the blue marks on the case and body, and push them until they click together. Make sure the syringe case is securely connected.

Make sure the Ring A in the photo is securely tightened up.

Coat the O-rings with vaseline if it gets hard to take the case off and put it back on.

WS12N

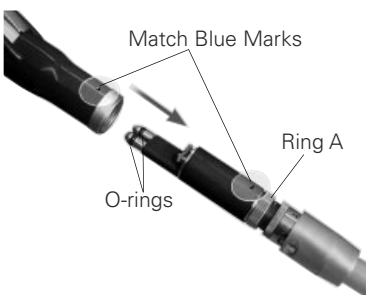

WS10-O-LD

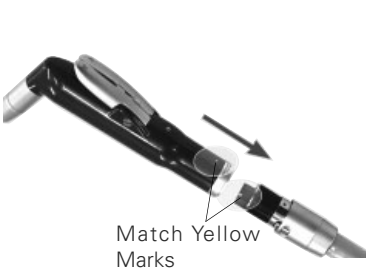

Match the yellow marks on the syringe and tube connector and push them together until they click. Make sure the syringe is securely connected.

### Taking Off the Syringe Case

Press down on the indented part of the syringe tube connector and pull the syringe case off the body.

WS12N

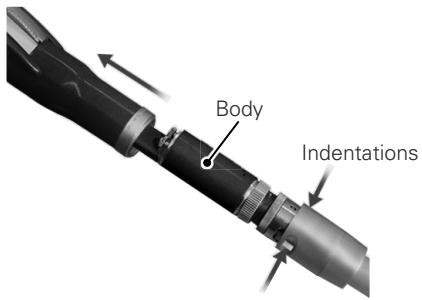

WS10-O-LD

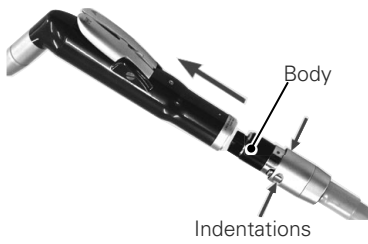

## 4.5.7 Vacuum Syringe

Suck out cutting debris and water from the oral cavity.

### ■ Vacuum syringe(VS90S)

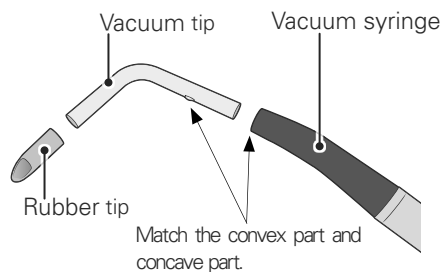
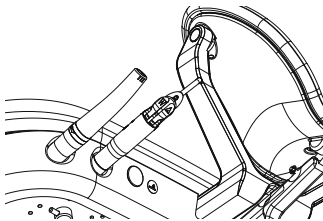

#### Starting and Stopping Suction

Suction starts automatically when the vacuum syringe is picked up from the instrument holder.

Suction stops when it is placed in the instrument holder.

#### Attaching the Vacuum tip and Rubber tip

Match the convex part in vacuum syringe and the concave part in vacuum tip, insert the vacuum tip into the vacuum syringe.

Insert the rubber tip into the vacuum tip.

When the vacuum tip is hard to be inserted, apply some Vaseline to the O-ring inside the vacuum syringe.

Do not turn around the vacuum tip forcedly. It may break the tip of vacuum syringe.

#### Removing the Vacuum tip and Rubber tip

Pull and remove the vacuum tip from the vacuum syringe.

Pull and remove the rubber tip from the vacuum tip.

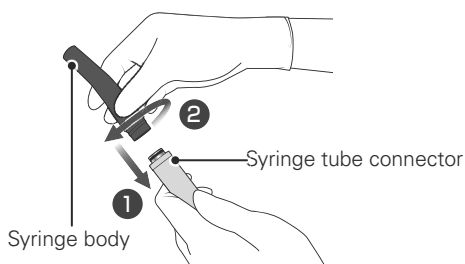

#### Attaching the syringe body

Turn the syringe body in the direction of the arrow (2) after inserting the syringe body into the syringe tube connector (1).

Please make sure that the syringe body is fixed certainly.

If the connection is insufficient, it may disconnect during use.

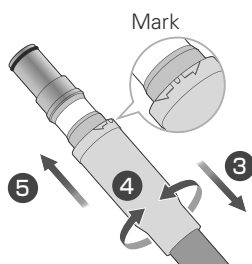

So that the main tube is not twisted when attaching, please adjust the direction of the vacuum syringe.

Lower the syringe tube connector when the main tube is not twisted.(3)

Turn to adjust the mark to the top position(4) and return it back again.(5)

Make sure the tube is not twisted when returning the vacuum syringe to instrument holder.

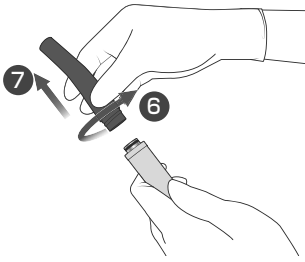

### Removing the syringe body

Turn the syringe body in the direction of the arrow to loose (6) and remove the syringe body from the Syringe tube connector (7).

Be sure to turn the syringe body when attaching and removing the syringe body, not to turn the Syringe tube connector.

## 4.5.8 Warmer Option

### CAUTION



When the warmer is ON, always be sure to check the temperature of the hot water before use. If the warmer is not needed, turn the switch OFF.

- Scalding due to high temperature and damage/faults due to heater overheating may occur.



When the warmer switch is turned on, hot water flows to the instruments.

[factory setting: OFF]

Check the water temperature of the threeway syringe before use.

Check the temperature enough where warm water is needed.

## 4.6 Operating Light

For details of how to handle the operating light, always refer to the separate operation instructions.

<b>⚠ WARNING</b>	
<b>!</b>	<p>Be careful that the light arm does not hit the patient or surroundings during lighting operations or when the chair moves.</p> <ul style="list-style-type: none"> <li>● This could result in accident or injury.</li> </ul>
<b>⊘</b>	<p>Do not subject the light (head, arm etc.) to excessive impacts or vibration.</p> <p>Do not let moisture adhere to the light. If the light gets wet, turn the main switch on the main unit OFF and wipe the light with a dry cloth etc. In this case, do not use the light until it is dry enough.</p> <ul style="list-style-type: none"> <li>● Accidents such as injury and damage/faults may occur.</li> </ul>

### 4.6.1 Operation and removable range

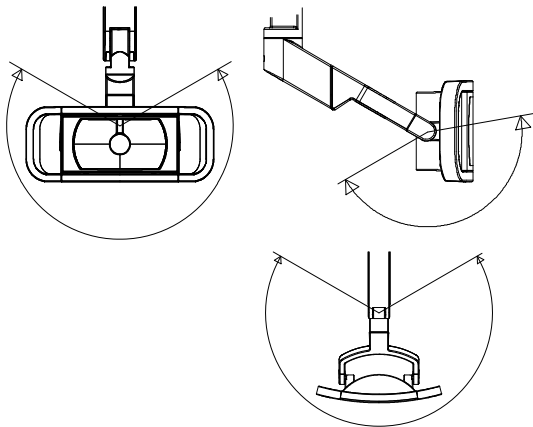

Use the handles to line up the light.  
Each part can remove as the right diagram range.

### 4.6.2 Light ON and OFF

#### ■ ON/OFF Operation

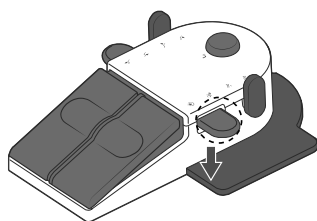

#### ON/OFF Using the Foot Control

The light can be switched ON/OFF by stepping on the foot pedal.  
The light goes ON/OFF each time the foot pedal is stepped on.

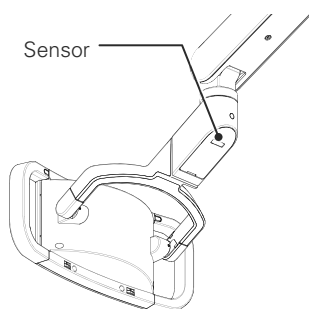

#### Touchless Sensor Option

When a hand is held over the sensor, the light turns ON/OFF.  
(The sensing distance of the sensor is about 100mm in the direction of the sensor.)

## 5 Caring for the Unit

### WARNING

	<p>Be sure to turn the main switch OFF when caring for/cleaning the main unit. Close the water supply valve and air supply valve as necessary.</p> <ul style="list-style-type: none"><li>● Accidents and faults due to unforeseen circumstances/electric shock etc. may occur.</li></ul>
	<p>Be sure to wear rubber gloves when caring for/ cleaning the main unit to prevent infection.</p> <ul style="list-style-type: none"><li>● An infection within the clinic may occur.</li></ul>
	<p>Sterilize and properly wipe successive parts such as each instrument that come into contact with the oral cavity.</p> <ul style="list-style-type: none"><li>● If proper sterilization and wiping are not carried out suitable hygiene management is not employed, a nosocomial infection may occur.</li></ul>
	<p>When using equipment such as an autoclave, follow the operation instructions for each device. Use the following temperatures corresponding to the sterilization regulations.</p> <ul style="list-style-type: none"><li>● Damage/faults both sterilized materials and equipment and an accident may occur.</li></ul>
	<p>The recommended autoclave sterilization conditions described in these operation instructions do not guarantee sterility. Always carry out sterilization validation by yourself.</p> <ul style="list-style-type: none"><li>● An infection within the clinic may occur.</li></ul>

### 5.1 Autoclave Sterilization

#### CAUTION

	<p>When autoclave sterilization is carried out, put items in a mesh basket, tray, sterilization pack etc. so that the sterilized material does not directly come into contact with the inner walls of the chamber.</p> <p>For models with high drying and standby temperature, remove the chamber promptly when sterilization is not being carried out.</p> <ul style="list-style-type: none"><li>● The inner wall of the chamber and the drying process may reach a higher temperature than the set sterilization temperature and damage to the sterilized material may occur.</li></ul>
---	---

### 5.1.1 Instrument Sterilization

<b>⚠ CAUTION</b>	
<b>!</b>	<p>If abnormalities such as deformation, degeneration, cracks etc. are found among sterilized sites, stop using the part and replace it with a new one. In particular, the resin products of the vacuum syringe and VS nozzle and SE flexible nozzle of the saliva ejector will be consumed faster than parts made of metal/silicone due to repeated sterilization.</p> <ul style="list-style-type: none"> <li>● Continued use while there are abnormalities may cause problems such as accidents due to unforeseen damage.</li> </ul>

Perform autoclave sterilization before and after treatment if necessary.

For details of the autoclave sterilization method, refer to the operation instructions of the relevant product.

Autoclave sterilization of the threeway syringe, vacuum syringe, and saliva ejector is carried out by removing the nozzle and tip from the main part. For the recommended conditions for autoclave sterilization refer to the following.

- Air turbine handpiece
- Micromotor attachment
- Micromotor motor cover
- How to remove the syringe case and nozzle of the threeway syringe (WS201/WS10-O-LD) pp. 29-32



WS10-O-LD

Autoclaving can degrade the LED; put the cap on the LED cover before autoclaving.

- How to remove the syringe body, VS nozzle and VS tip of the vacuum syringe (VS90S) p. 33

Sterilized site	Sterilization temperature	Sterilization period
Syringe case, nozzle of the threeway syringe (WS201)	134±1°C	10 minutes or more
Syringe case, nozzle of the threeway syringe (WS12)	134±1°C	10 minutes or more
Syringe case, nozzle of the threeway syringe (WS10-O-LD)	134±1°C	6 minutes or more
Syringe body, nozzle of the vacuum syringe	134±1°C	10 minutes or more



## 5.1.2 Instrument Holder Sterilization

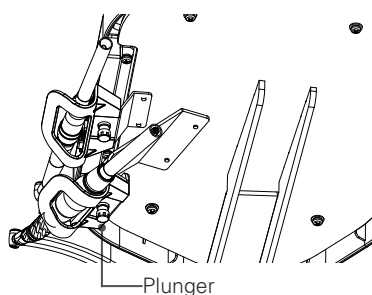

### Instrument Holder Removal

Before removing the holder, turn the power OFF, and remove the instrument.

- ① Remove the holder while pulling the plunger.

### Autoclave Sterilization

Recommended conditions 134±1°C, 5 minutes or more

### Instrument Holder Installation

- ① Return the holder while pulling the plunger.

## 5.1.3 Other Sterilization

Perform autoclave sterilization before and after treatment if necessary.

### ■ Operating Light Handle or Handle Cover

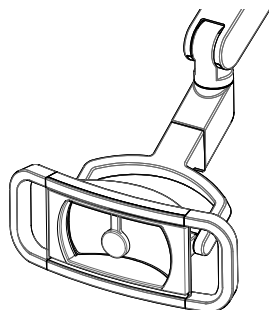

For details of the autoclave sterilization method, refer to the operation instructions of the relevant product.

### ■ Silicone Tray Sheet Option



Autoclave sterilization Recommended conditions  
134±1°C 5 minutes or more

### ■ Vial Holder Option

Autoclave sterilization Recommended conditions  
134±1°C 5 minutes or more





## 5.2 Wiping with Disinfectant Ethanol

 CAUTION	
	<p>When cleaning with ethanol, always use disinfectant ethanol(76.9-81.4vol%).</p> <ul style="list-style-type: none"> <li>● Using other ethanols, solvents etc. may cause degeneration/deterioration/faults.</li> </ul>
	<p>When cleaning with ethanol, please avoid the areas where ethanol may ingress such as the gaps around joint/rotation axes/switches.</p> <p>Do not use excessive ethanol for other parts.</p> <ul style="list-style-type: none"> <li>● Accidents due to a short circuit, degeneration, deterioration or damage may occur.</li> </ul>
	<p>After cleaning with ethanol, do not place with other products (for example, do not put a mouse pad on the silicone tray sheet). Dry thoroughly and store separately.</p> <ul style="list-style-type: none"> <li>● Color transfer from other products, deterioration may occur due to the effects of ethanol.</li> </ul>

### 5.2.1 Instrument Wiping

Wipe with disinfectant ethanol before and after treatment if necessary.

For details of the wiping method, refer to the operation instructions of the product.

- Air turbine handpiece
- Micromotor attachment
- Micromotor motor cover
- How to remove the syringe case and nozzle of the threeway syringe (WS201)  p. 29
- How to remove the syringe body, VS nozzle and VS tip of the vacuum syringe (VS90S)  p. 33

## 5.2.2 Wiping the Leather Seat

### CAUTION

Do not subject the leather seat to the following conditions.

- ① Contact with clothing and bags containing dyestuffs such as real leather and denim  
(risk of discoloration due to color transfer/degeneration)
- ② Contact with vinyl/styrene/ABS/wood products/painted products  
(risk of discoloration and degeneration/cracks)
- ③ Contact with printed materials such as newspapers and magazines/printed pattern fabrics  
(risk of color transfer and disfiguration)
- ④ Contact and use of solvents/paints/chemicals/ adhesives/adhesive tapes etc.  
(damage and deformation/discoloration/degeneration/hardening/softening)
- ⑤ Use of bleach  
(risk of discoloration and degeneration)
- ⑥ Contact with or proximity to a heat source such as an iron or a stove  
(damage and deformation/discoloration/degeneration)
- ⑦ Partial loading due to being pressed against, scuffed, etc.  
(damage and deformation/discoloration/degeneration)
- This may cause damage/degeneration/discoloration etc. of the leather seat or other parts.

- ① Wipe using a soft cloth or sponge containing a small amount of disinfectant ethanol, the supplied cleaning agent, a neutral detergent, or water.
- ② Then, wipe with a dry cloth, taking care not to leave any residual moisture or detergent.

Please note that leather seats of certain colors are not compatible with disinfectant ethanol.

## 5.2.3 Wiping Other Parts



Wipe with disinfectant ethanol before and after treatment if necessary.

Wipe with a soft cloth such as gauze containing a small amount of disinfectant ethanol.

Wring out the cloth so it does not contain an excessive amount of disinfectant ethanol.

- Operating Light Handle or Handle Cover
  - Operating Light Main Surface
  - NOTE: For details of the wiping method, refer to the operation instructions for the product.
- Instrument main tube
- Display panel
- Silicone tray sheet **Option**
- Vial holder **Option**

### 5.3 Other Cleaning Methods

 CAUTION	
	<p>Do not dry heat (with dry sterilizer)/sterilize the various parts of the main unit.</p> <ul style="list-style-type: none"> <li>● Discoloration/deterioration/faults may occur due to the high temperature.</li> </ul>
	<p>Do not soak, rinse, or boil any part of the main unit with a cleanser containing disinfectant ethanol or solvent (such as benzine or a thinner).</p> <ul style="list-style-type: none"> <li>● Discoloration/deterioration/faults may occur.</li> </ul>

Other sterilization/ disinfection methods may have adverse effects on the main unit and parts.  
 Consult your reseller or the nearest MORITA CORP. subsidiary in advance.

## 5.4 Everyday Maintenance (before treatment)

### CAUTION



Once a day, before commencing treatment, drain residual water from the main unit using the following procedure.

Take particular care after if the water has been there for a longer period, such as the day after a holiday.

- Since a certain amount of water remains in the warmer tank and tubes of the main unit and the quality of water will decrease if it is left for a long period, the remaining water should be discharged before use.

Before commencing daily treatment, drain residual water from the main unit from each water line.

### 5.4.1 Flushing of Residual Water

#### ■ Manual flushing

Water remaining in the water lines is flushed manually.

Carry out in the following procedures in the given order. If you do not follow this order, the flushing process will be less efficient.

Flushing the threeway syringe circuit



Flushing the air turbine handpiece circuit



Flushing the micromotor circuit

The time required to flush each water line (refer to the table on the right) depends on the quantity of water within the main unit.

Besides the water in the main body of the unit, there may be water in the piping and so we recommend that you flush the circuits for longer than is specified in the table.

**Estimated flushing times for each water line**

Water line	Estimate
1 Threeway syringe	At 1 minute or more each
2 Air turbine	At 1 minute or more each
3 Micromotor	At 2 minute or more each

### Threeway syringe circuit residual water drainage

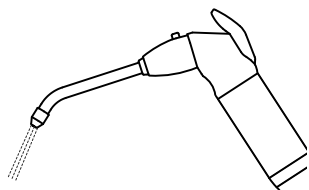

- ① Remove the threeway syringe from the instrument holder.
- ② Point the tip of the syringe toward the basin, push the W lever and flush for at least 1 minute.
- ③ Do this for the both doctor side and assistant side.
- ④ When finished, placed the threeway syringe in the instrument holder.

### Flushing the air turbine circuit

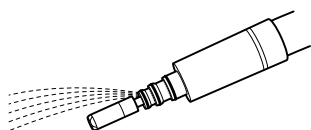

- ① Remove the handpiece from the instrument holder.
- ② Switch ON the water flow ON/OFF switch on the doctor-side operation panel.
- ③ Remove the air turbine from the tube.
- ④ Point the tip of the tube toward the basin, step on the foot control pedal, and flush for at least 1 minute.
- ⑤ On completion, connect the air turbine to the tube, and place it in the instrument holder.

If there is a second circuit (option), follow the same procedure.

### Flushing the micromotor circuit

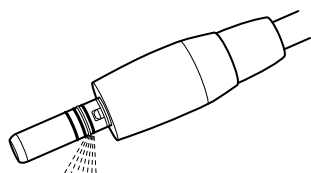

- ① Remove the micromotor from the instrument holder.
- ② Switch ON the water flow ON/OFF switch on the doctor-side operation panel.
- ③ Remove the straight handpiece and contra-angle handpiece from the micromotor.
- ④ Point the water supply port at the tip of the micromotor towards the basin, press the foot control pedal and flush for at least 2 minutes.  
The water supply port is located beside the connecting tube. Check the position then flush.
- ⑤ When finished, place the motor in the instrument holder.

## 5.5 Everyday Maintenance (after use)

### 5.5.1 Cleaning the Vacuum Filter

#### ⚠ CAUTION



When installing the vacuum filter, be sure it is fully inserted.

- If the vacuum filter is not fitted properly, the performance of the vacuum syringe/saliva ejector may be adversely effective, or a malfunction/clogging etc. may occur.

Every day after use, clean the vacuum filter on the assistant-side holder.



- ① Turn the main switch OFF.
- ② Clean each vacuum pipeline and saliva ejector pipeline.  
Remove the vacuum filter on the assistant-side holder side.  
Grip the knob and pull it straight out.
- ③ Slide the knob part of the vacuum filter in the direction of the arrow to disassemble.  
After disassembling, rinse in running water.  
The vacuum filter is a consumable part. It may cause injuries by the broken filter net. Please exchange to a new one.

### 5.5.2 Cleaning the Main Tube's Inner Side of Vacuum Syringe

#### ⚠ CAUTION



For the vacuum system cleanser, use "Mazak P" specified by MORITA.

Follow the instructions supplied with the cleanser.

- Failure to follow these instructions may lead to damage to the circuits or tubes, and damage, faults, water leaks or loss of suction may occur.

Clean the inside of the main tube, during the between patients.

Correct

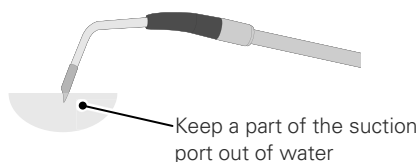

Incorrect

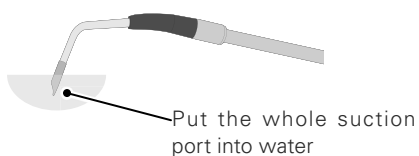

- ① Turn on the main switch.
- ② Pick up the vacuum syringe from instrument holder, to suck 1-2 cups of water.  
During the suction, keep a part of the suction port out of water, to mix in some air.  
Do not put the whole suction port into water. It may cause a malfunction in vacuum motor by suction over the vacuum tank's capacity.
- ③ Return the vacuum syringe to its holder.

## 5.6 Monthly Maintenance

### 5.6.1 Cleaning the Oil Collector

#### ⚠ CAUTION



Clean the inside of the oil collector at least once a month.

● Failure to do so may cause overflow of oil from the oil collector or other faults.

At least once a month, discard the oil collected in the oil collector on the underside of the tray.

Also check that the air turbine exhaust is normal.

Even at less than a month, discard the oil if it is above the level line on the oil cup.

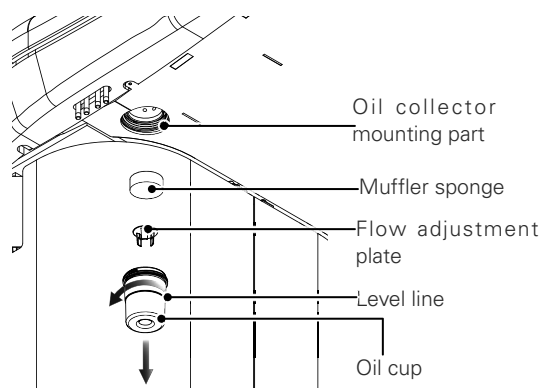

- ① Turn the oil cup in the direction of the arrow to remove it.  
During removal, take care not to spill the collected oil.
- ② Soak up the oil in the oil cup using paper etc. and discard it.
- ③ Remove the flow adjustment plate located in the oil cup.
- ④ Pull out the muffler sponge fitted in the oil collector mounting part in the tray.
- ⑤ Rinse the oil cup, flow adjustment plate, and muffler sponge in running water.  
After rinsing, remove all moisture from the surface.
- ⑥ Install by reversing the above procedure.  
Fit the muffler sponge into the oil collector mounting on side of the tray.  
With the flow adjustment plate fitted in place, screw in the oil cup.
- ⑦ After installing the oil collector, check the condition of the air turbine exhaust.  
If exhaust air is not emitted, stop using the device, and consult a reseller or MORITA CORP. subsidiary.





If the O-ring at the tip of the air turbine tube is broken, water may accumulate in the oil collector over a short period of time.

If this happens, replace the O-ring with a new one.



## 5.7 Annual Maintenance

### 5.7.1 Sterapore Cartridge Replacement Option

 <b>WARNING</b>	
	<p>Do not bring fingers close to the electrical parts inside the piping pit and do not expose parts to water. Do not operate the chair when the piping pit is open.</p> <ul style="list-style-type: none"> <li>● Accidents such as an electric shock, short-circuit and pinching and damage/faults may occur.</li> </ul>
 <b>CAUTION</b>	
	<p>Be careful to avoid the following when handling sterapore cartridges.</p> <ol style="list-style-type: none"> <li>① Mixing up water and air cartridges</li> <li>② Misconnecting IN and OUT</li> <li>③ Disassembling cartridges</li> <li>④ Reconnecting used cartridges</li> <li>⑤ Using cartridges other than those normally connected to the mains water supply and or compressed air circuits</li> <li>⑥ Using cartridges other than products designated by us</li> </ol> <ul style="list-style-type: none"> <li>● Not only will it be impossible to achieve the desired effects, but it may cause water leaks and air leaks and damage the unit.</li> </ul>
	<p>Before removing the sterapore cartridge, be sure to relieve the pressure within the circuit by following the procedure in these instructions.</p> <ul style="list-style-type: none"> <li>● Forcibly removing it may lead to injury and other accidents.</li> </ul>
	<p>Be sure to always close the water supply valve and air supply valve before starting replacement.</p> <ul style="list-style-type: none"> <li>● Failure to do so may cause water/air leaks.</li> </ul>
	<p>Be sure replace the sterapore cartridge every year.</p> <p>If a deterioration in performance is seen at less than one year due to water quality fluctuations etc, promptly replace the sterapore cartridge.</p> <ul style="list-style-type: none"> <li>● Failure to replace the cartridge may cause water and air leaks due to a degradation in performance, pipeline clogging, pipeline foreign matter etc. or a fault.</li> </ul>
	<p>Securely connect the sterapore cartridge.</p> <ul style="list-style-type: none"> <li>● If the connection is incorrect or insufficient, a water leak/air leak/damage/fault may occur.</li> </ul>

Replace the sterapore cartridge once a year.

## ■ Removing the Pit Cover

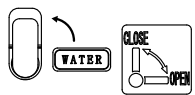

Water Supply Valve



Air supply valve

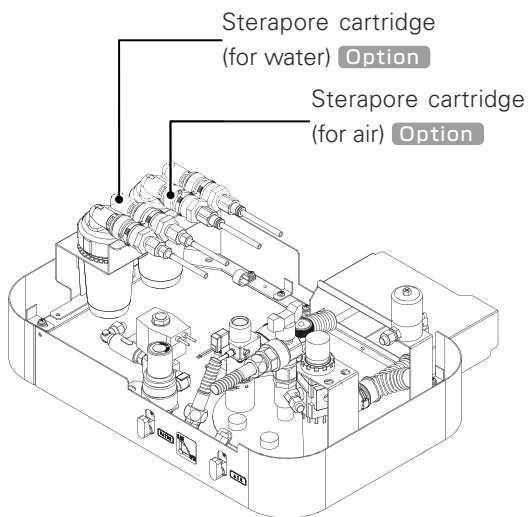
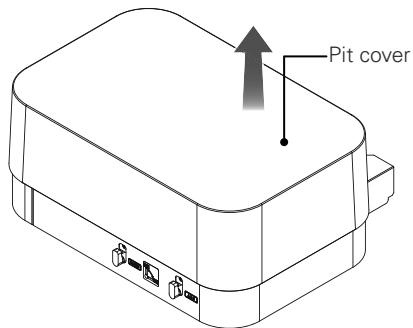

① Turn the main switch OFF.

② Close the water supply valve and air supply valve by turning them in the direction of the arrow.

Expel water and air from the three-way syringe to relieve the internal pressure in the water and air circuits.

③ Lift off the pit cover of the piping pit.

## ■ Removing and Installing Sterapore Cartridges Option

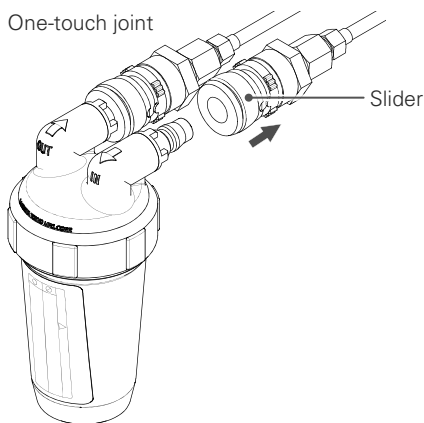
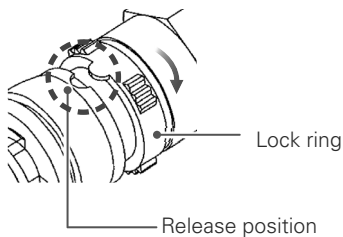

### 1. Disconnecting the One-touch Joint

#### ① Disconnect the one-touch joint.

Rotate the lock ring in the direction of the arrow and align the semicircular protrusion with the release position.

#### ② Slide the slider part of the one-touch joint in the direction of the arrow to release the one-touch joint.

Remove the IN side then the OUT side.

When removing the one-touch joints of the sterapore cartridge for water, be sure to put a rag or the like underneath as water in the cartridge may spill.

### 2. Installing the Sterapore Cartridge

#### ① Enter the date of placement on the label of the new sterapore cartridge.

#### ② Connect the new sterapore cartridge.

Connect the one-touch joints to the connectors of the sterapore cartridge, making sure to match the colors

● For water: IN side (light blue)  
OUT side (blue)

● For air: IN side (gray)  
OUT side (black)

Push the one-touch joint until you hear a click.

After connecting, confirm that it is securely connected.

#### ③ Lock the connection.

Rotate the lock ring in the direction of the arrow until it can go no further.

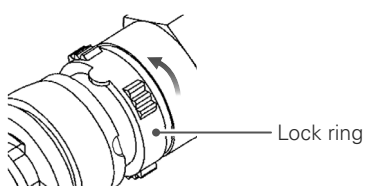
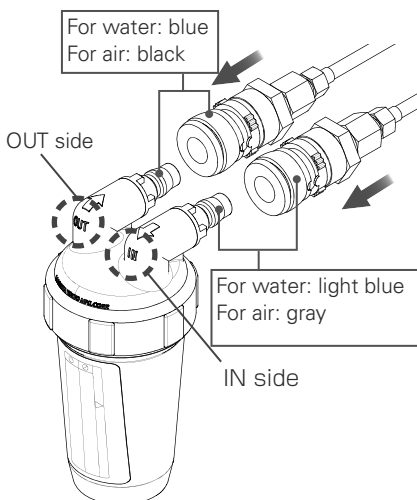

- ④ Position the sterapore cartridge in the pit as before.
- ⑤ Turn the main switch ON.
- ⑥ Open the water supply valve and air supply valve by turning them in the direction of the arrows.
- ⑦ Expel water/air from the threeway syringe.  
Check that water/air is being properly expelled and that there are no leaks around the one-touch joints.
- ⑧ Turn the main switch OFF and install the pit cover.
- ⑨ Turn the main switch ON again and check that there are nothing abnormal occurs in various operations.

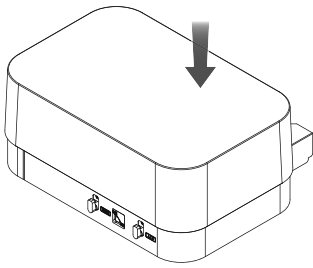

When a sterapore cartridge for water is replaced, air is introduced into the water line. Operate the automatic filler, running the water until no more air is introduced.

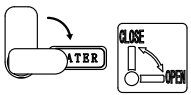



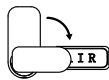



Water Supply Valve



Air supply valve



## 5.8 Maintenance as Required

 <b>WARNING</b>	
	<p>Do not leave moisture, detergent, ethanol etc on the main unit surface or inside the device.</p> <p>Do not allow moisture to adhere inside and do not do anything that could cause water to enter the unit such as directly wetting the panel switches and automatic filler.</p> <p>In the event that water does adhere, turn the main switch OFF, wipe thoroughly with a dry cloth etc. and dry thoroughly before reuse.</p> <ul style="list-style-type: none"> <li>● Accidents such as fire due to a short circuit, discoloration/deterioration/malfunction/faults may occur.</li> </ul>
 <b>CAUTION</b>	
	<p>When cleaning each part of the main unit, do not use a cleaning agent other than the supplied cleaning agent (or neutral detergent).</p> <ul style="list-style-type: none"> <li>● If you use chemical wipes, cleaning products impregnated with chemicals or items containing cleansers besides disinfectant ethanol (benzene, thinners etc.), it may adversely affect the unit, causing discoloration, degradation and faults.</li> </ul>
	<p>Do not apply wax and solvents designed for use on floors to the housing/foot control etc.</p> <p>In the event that a product does adhere, wipe it off promptly.</p> <ul style="list-style-type: none"> <li>● If the product is left it may cause discoloration/deterioration/faults.</li> </ul>
	<p>When cleaning the main unit, do not spray water, cleaning agent etc. directly on the main switch.</p> <ul style="list-style-type: none"> <li>● This may cause a fault.</li> </ul>
	<p>If chemicals adhere to resin parts such as the instrument holders or tray surfaces, wipe them off immediately using a soft cloth with a little disinfectant ethanol.</p> <p>Do not allow ethanol to enter inside the main unit.</p> <ul style="list-style-type: none"> <li>● Leaving chemicals adhering may cause discoloration or deterioration.</li> </ul>

### 5.8.1 Cleaning Other Parts

- ① Add water, the supplied cleaning agent, neutral detergent, or disinfectant ethanol to a soft cloth, sponge etc. and wipe it off.
- ② Then, wipe with a dry cloth, taking care not to leave any residual moisture or detergent.

# 6 Maintenance and Inspection

 <b>WARNING</b>	
	Carry out maintenance and inspection in order to use this product safely and comfortably. ● Failure to do so may cause a fault or unexpected accident.
	When reusing the unit after leaving it for a long period of time, always check that the main unit operates normally and safely before use. ● Failure to do so may cause a fault or unexpected accident.
	If you think there is a fault, check this according to “7. Troubleshooting” in these operation instructions and consult the local reseller or MORITA CORP. subsidiary. ● It is dangerous to disassemble, repair, or reconstruct this unit without permission.
	Regularly check and clean the circuit board (and earth) inside the chair to prevent dust from adhering. ● Accidents such as fire, electric shock etc. may occur.
	Do not perform maintenance checks on this product during patient treatment. ● Accidents and faults due to unforeseen circumstances/electric shock etc. may occur.

Since this product falls into the category of medical equipment requiring specialist maintenance and management, the medical facility should carry out maintenance and inspection (daily inspection and periodic maintenance inspection).

For instruments, operating lights, visible light irradiators etc., refer to the operation instructions and inspection list supplied with the product.

Parts list/technical data etc. for this product will be distributed at the request of repair companies. Contact your reseller or MORITA CORP. subsidiary.

## 6.1 Replacement of Consumable Parts

To maintain performance and ensure safety, replace consumable parts as set out in the following table.

When ordering and replacing consumable parts, contact your reseller or MORITA CORP. subsidiary. For the disposal methods of replaced parts, refer to “9. Medical Device Disposal” in these operation instructions.

When 10 years have elapsed after discontinuing production of this product, we may not be able to supply parts.

### 6.1.1 List of Consumable Parts

List of consumable parts			
No	Part name	Replacement timing	Replacement method
1	Various filters · Filter of vacuum filter · Water supply filter	When damage, contamination, abrasions or stretching is observed; When the performance level drops	Consult with your reseller or the nearest MORITA CORP. subsidiary.
2	Sterapore cartridge <b>Option</b> · for water · for air	After 1 year of use; When the performance level drops	Refer to "5.71 Sterapore Cartridge Replacement." ☞ pp. 47-50
3	Various O-rings, packing, diaphragms · O-ring of vacuum filter · O-ring for the vacuum syringe · Valve plate for the vacuum tank waste water · Valve plate for the vacuum tank waste water	When damage, contamination, abrasions or stretching is observed; When the performance level drops	Consult with your reseller or the nearest MORITA CORP. subsidiary.
4	Various seats Seat, backrest and headrest's leather	When damage, contamination, abrasions is observed; When the performance level drops	Consult with your reseller or the nearest MORITA CORP. subsidiary.
5	Various main tubes	When damage, contamination, abrasions is observed; When the performance level drops	Consult with your reseller or the nearest MORITA CORP. subsidiary.
6	Various tubes for piping (Vacuum piping, etc.)	When damage, abrasions is observed; When the performance level drops	Consult with your reseller or the nearest MORITA CORP. subsidiary.
7	Various fuses	When it blows	Consult with your reseller or the nearest MORITA CORP. subsidiary.
8	Lights	When it blows	Consult with your reseller or the nearest MORITA CORP. subsidiary.
9	Covers · Canopy <b>Option</b>	When damage, contamination, abrasions or stretching is observed; When the performance level drops	Consult with your reseller or the nearest MORITA CORP. subsidiary.
10	Various silicone products · Vial holder <b>Option</b> · Silicone tray sheet <b>Option</b>	When damage, contamination, abrasions or stretching is observed; When the performance level drops	Consult with your reseller or the nearest MORITA CORP. subsidiary.
11	Parts for autoclave sterilization	When damage, contamination, abrasions is observed; When the performance level drops	Consult with your reseller or the nearest MORITA CORP. subsidiary.
12	Various disposable/paper products · Tray paper	Every examination	Consult with your reseller or the nearest MORITA CORP. subsidiary.
13	Instrument holder	When damage, contamination, abrasions is observed; When the performance level drops	Consult with your reseller or the nearest MORITA CORP. subsidiary.
14	Muffler sponge for the oil collector	When damage, contamination, abrasions is observed; When the performance level drops	Consult with your reseller or the nearest MORITA CORP. subsidiary.

List of consumable parts			
No.	Part name	Replacement timing	Replacement method
15	Flexible tube for drainage/suction	When damage, contamination, abrasions is observed; When the performance level drops	Consult with your reseller or the nearest MORITA CORP. subsidiary.
16	Syringe case, nozzle of the threeway syringe	When damage, contamination, abrasions is observed; When the performance level drops	Consult with your reseller or the nearest MORITA CORP. subsidiary.
17	Various vacuum syringe nozzles, various tips	When damage, contamination, abrasions is observed; When the performance level drops	Consult with your reseller or the nearest MORITA CORP. subsidiary.
18	MORITA multispray	When it runs out	Consult with your reseller or the nearest MORITA CORP. subsidiary.



## 6.1.2 Parts Replacement for Threeway Syringe

### LED Replacement for light-equipped model Option

<b>⚠ WARNING</b>	
<b>!</b>	Turn off the main switch before replacing the LED to avoid the risk of electric shocks or burns.
<b>⊘</b>	Do not shine the LED directly into the eye. This could impair one's eyesight.
<b>⚠ CAUTION</b>	
<b>⊘</b>	Avoid getting burned by the LED or the LED cover, which can get quite hot. Wait for them to cool off before replacing the LED.
<b>⊘</b>	Make sure the nozzle click into place securely; otherwise, air pressure could blow it off the syringe.

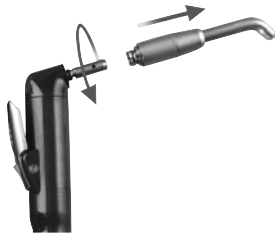

- ① Take the nozzle off the syringe and remove the LED cover by turning it in the direction indicated by the arrow in the illustration.

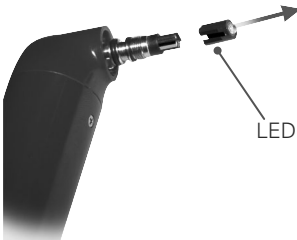

- ② Take the LED out of its socket.

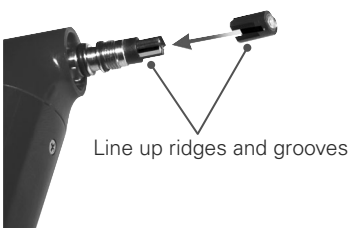

- ③ Line up the ridges and grooves and push the new LED straight into place.



- ④ Replace the LED cover. Slide the nozzle in until it clicks into place. Connect the syringe to its tube and see if the light works properly.

Water or air might leak if the LED cover is not tightened up properly.

## 6.2 Daily Inspection by the User

Inspect the device according to the table below and check that there are no abnormalities/ defects.

Carry out before use (startup inspection) and after use (shutdown inspection).

If an issue discovered at inspection is beyond the scope of the actions in the table or if any abnormality is found, consult your reseller or nearest MORITA CORP. subsidiary.

### 6.2.1 Startup Inspection

Check the contents of the table below before use.

No	Inspection item	Action	Reference page
1	Is there rattling or looseness in the body/light/arm/seat/instrument holder?	Adjust and tighten.	p9,p21,p22, p36
2	Is there anything under the seat interfering with operation?	Make enough space around the seat and remove impediments, if any.	p16
3	Can the chair be stopped correctly?	Make sure that stopping (stop operation and operation of the various safety switches) can be performed normally.	p16,p18
4	Are there any leaks in the water supply line/air/sterapore cartridgewater supply device/main tubes (abnormalities such as leak marks, dripping noises)?	Check each part and correct connections.	p8,pp29-32, p49
5	Are there any abnormalities such as rubbing, dislocation,tilting, noises etc. in the main unit housing (base housing/pit housing)?	With the chair raised, check visually that there are no abnormalities.	pp17-18
6	Do the foot control and instruments (air turbine, motor, ultrasonic scaler, etc.) operate correctly?	Carry out trial operation to see if there are abnormalities in the switches/display/operation etc. Also check option specifications such as clean air system.	pp17-18, p24
7	Can the chair lock etc.be used properly?	Ensure that they can be used correctly and that the amount of adjustment/operation time is appropriate.	p19

### 6.2.2 Shutdown Inspection

Check after use.

No	Inspection item	Action	Reference page
1	Is the main switch OFF?	Turn the main switch OFF.	p13

## 6.3 Regular Maintenance Inspection

According to the Ordinance for Enforcement of the Medical Practitioners' Act and the notification from the Director of the Ministry

of Health, Labor and Welfare, maintenance and inspection is designated, in principle, as work performed by medical institutions. Please carry out an inspection every 6 months in accordance with the regular maintenance and inspection list set out in the separately attached to the warranty card.

If any abnormality is found, please contact your reseller or MORITA CORP. subsidiary.

Note also that the inspection can be outsourced. For details, please contact your reseller or MORITA CORP. subsidiary.

### 6.3.1 Maintenance and Inspection by the User

Have the contractor check the items listed in the table below.

No	Content of inspection
1	Movement of the seat and backrest (manual operation)
2	Movement of the seat and backrest (automatic operation)
3	Stop automatic operation and safety lock
4	Headrest operation
5	Mounting condition of seat and backrest
6	Installation of tray arm
7	Sterapore cartridge(water supply/air supply)
8	Air turbine handpiece connection
9	Operation of and air pressure supply to the air turbine handpiece
10	Air turbine hand piece circuit and water flow/lighting conditions
11	Micromotor connection and operation
12	Micromotor circuit and water flow/lighting conditions
13	Connection and operation of vacuum syringe
14	Threeway syringe connection and operation

### 6.3.2 Outsourcing Maintenance and Inspection to a Contractor

Have the contractor check the items listed in the table below.

No	Content of inspection
1	Power supply voltage for device operation
2	Floor and fixing condition
3	State of electric circuit wiring
4	State of piping/tubes
5	Assembly condition of screws and exterior
6	Contamination within the unit
7	Operating light power-supply voltage

## **6.4 After-sales Service and Contact Information**

If after-sales service is required, please contact your local dealer.

# 7 If Problems Arise





## 7.1 Items to be Checked before Requesting Repair

If problems occur during use, refer to the table below, check and take action.

If an improvement is not achieved even when the following checks are performed and actions are taken, or if any abnormality other than those in the description is found, please stop using the device and consult with your reseller or nearest MORITA CORP.

Symptoms	Possible cause	Checks/actions	Reference page
Even with the main switch ON, there is no power	The room breaker is OFF	Switch ON the circuit breaker on the interior distribution board.	-
	Fuse has blown	Request a fuse replacement.	p61
The seat and backrest do not move	A safety switch has been triggered	Remove impediments.	p16
	A temporary abnormality due to unforeseen circumstances such as electrical noise	Briefly turn the main switch OFF and turn it ON again.	pp12-13
It cannot be operated	Chair lock is in operation	Release the chair lock switch.	p19
The micromotor does not work	Fuse has blown	Replace the motor fuse.	p61
Water and air not come out the Threeway Syringe	Take off the nozzle and press the levers, water and air come out.	Nozzle may be clogged. Clean by blowing air through connection end. Also wash with water. Also check for worn or defective O-rings.	p44
	Take off the nozzle and press the levers, No water or air.	Take off syringe case and reattach it. Line up blue marks and put case on until there is an audible click. If this does not solve the problem, valves in syringe body may be clogged. Have chair inspected and repaired.	p31, p44
Threewaysyringe light does not work even when light is turned on.	Replace LED.	See manual for threeway syringe. If this does not solve the problem, have chair inspected and repaired. (Probable broken wire or short inside tube.)	p55
The vacuum syringe does not suck or suction is weak	The vacuum filter is contaminated.	Clean them.	p41
	The vacuum filter is improperly installed and there is a gap in the connection	Install it correctly.	p41

## 7.2 Fuse

 <b>WARNING</b>	
	When replacing the fuse, always turn the main switch OFF. ● Failure to do so may result in an accident such as an electric shock or a fault.
	If a fuse blows, there may be a problem with the electric wiring, so promptly consult your reseller or nearest MORITA CORP. subsidiary for an inspection. ● If the unit continues to be used as is, an accident caused by electric leakage etc. or failure may occur.
 <b>CAUTION</b>	
	When replacing the fuse, be sure to use a fuse of the same rating, same characteristics, and same type as the IEC standard. ● Using a substitute items (such as wire) could result in a fire due to overheating of the electric wires.

Fuse replacement should be performed by a technical service representative.  
Ask your reseller or nearest MORITA CORP. subsidiary.

### ■ When use is interrupted, after completion of treatment

When the fuse blows, replace it with a new one using the following procedure.  
Use a medium Phillips screwdriver.

- ① Turn the main switch OFF.
- ② Lift the pit cover up and remove it.
- ③ Replace the fuse in the fuse holder.  
Remove the cap of the fuse holder (15A uses a medium-sizes Phillips screwdriver), extract the blown fuse, and replace it with a new one.  
Be sure not to confuse the rating, characteristics, and model of fuse.
- ④ Installation is completed by installing each part in reverse order.

If the fuse blows again, the electric wiring may be abnormal.  
At this time, stop using the device, turn the main switch OFF and ask your reseller or the nearest MORITA CORP. subsidiary for an inspection.

\*1: conditions vary depending on specifications. Follow the main unit notes.

# 8 Warranty and Repair

## 8.1 Warranty of this Product

In the event of a malfunction following correct use in accordance with the operation instructions, the product will be repaired or replaced free of charge within the warranty period based on the conditions and scope described in the separate Warranty Card. Read the "Content of Warranty" on the back of the Warranty Card for details.

## 8.2 Warranty Card

When purchasing this unit, fill out the prescribed details on the separate Warranty Card, give it to the reseller, and keep the warranty in a safe place.

## 8.3 Repair

### 8.3.1 Before Requesting a Repair

Please check the symptoms/condition according to "7. Troubleshooting" in these operation instructions before requesting a repair.

### 8.3.2 Requesting a Repair

#### ■ Repair request within the warranty period

Attach the Warranty Card, and send the request to your reseller or nearest MORITA CORP. subsidiary. We will respond free of charge.

You will bear the actual cost of parts not covered by the warranty such as consumable parts.

#### ■ Repair request outside the warranty period

Consult your reseller or nearest MORITA CORP. subsidiary. If the performance can be maintained/restored by repair/parts exchange, we will apply a charge.

### 8.3.3 Spare Part Maintenance Period

The manufacturer's stores spare parts for a period 10 years after discontinuation of the product. It may not be possible to respond to repair requests/parts orders after this period has elapsed.



## 9 Disposal of the Medical Device

---

### 9.1 Disposal of This Product

This product and accompanying parts/consumable parts fall into the category of medical devices. Please observe the disposal regulations in the applicable area.

Check with a dentist or physician that the infectious waste from the medical device is in a non-infectious state and ensure that the medical institution consigns industrial waste material and industrial waste subject to special control to a processing company qualified to deal with it.

Follow regional provisions for waste material and packaging materials that are not regarded as infectious waste.

# 10 General Information









## 10.1 Specifications

Name	Signo Z300
Non-proprietary name	Dental Treatment Unit
Manufacture and marketing	J. MORITA TOKYO MFG. CORP.
Model	MUX
Intended purpose	This product, installed in a dental clinic, locates a patient to a position for medical examination, delivers air, water, vacuum, and electricity to dental equipment which is intended to be attached and operates it.
Power-supply voltage	220/230/240V AC
Power supply input	1.5 kVA
Frequency	50/60 Hz
Input pressure	0.39-0.78 MPa(air) 0.20-0.59 MPa(water)
Vibration mode	Longest 25 seconds ON/ shortest 400 seconds OFF (Electric motor)
Protect against electrical shock	Class I Equipment Permanently installed devices Type B applied part. * However, connected devices follow the classification of each device.
Applied parts	Type B(micromoter,air turbine)
Protection from harmful ingress of water or ingress of solids.	IPX1(foot control)
Seat pad height (from the floor)	Lowest position 610mm±10mm Highest position 860mm±10mm
Weight	About 1765N (180kg)
Auxiliary base <b>Option</b>	About About 392N (40kg)
Maximum weight load	About 1470N (150kg)
Seat lifting system	Electric actuator
Threeway syringe water jet/spray amount	30mL/15 sec or more(WS201) 60mL/15 sec or more(WS12N)
Vacuum syringe suction volume	140 L/min or more (Suction motor performance: equivalent to 15 kPa at low suction 0.17 m <sup>3</sup> / min ~ equivalent to 17.64 kPa at high suction 0.6 m <sup>3</sup> / min ) <sup>Note 1</sup>
Vacuum syringe vacuum	-8.0 kPa (static pressure) (suction motor performance: flow 900 L/min, suction pressure 14.0 kPa) <sup>Note 1</sup>
Maximum permitted load	Foot control pedal: 1350 N
EMC specifications	Conforms to IEC 60601-1-2:2014

[Please note that specifications and appearance may change without prior notice for product improvement purposes.]

Note 1: Low suction: equivalent to EV- 12- II of J MORITA CORP. / high suction: equivalent to TCS- 1.5 MAX of TOKYO GIKEN,INC.



## 10.2 Symbols

	Manufacturer		Alternating current
	Date of manufacture		Type B applied part
	Serial number		Type BF applied part
	Conforms with the WEEE Directive		ON/OFF (push-push)
<b>IP X 1</b>	IP code Liquid ingress protection; Level 1		Refer to instruction manual/booklet

## 10.3 EMC Electromagnetic Compatibility EMC

MUX conforms to electromagnetic compatibility in IEC60601-1-2 : 2014.

The following sentences are "Guidelines and a Declaration of Manufacturers and Distributors" required as attached document according to IEC60601-1-2 : 2014 on electromagnetic compatibility.

 <b>WARNING</b>	
	This product requires precautions related to EMC and it is necessary to install and use the product according to the EMC information described in these operation instructions.
	Portable and mobile RF communication equipment may affect this product.
	Portable RF communications equipment should be used no closer than 30cm(12 inches) to any part of the MUX, otherwise, degradation of the performance this equipment could result.
	If accessories other than those sold as replacement parts by the marketing authorization holder are used, performance of this product may deteriorate regarding EMC.
	The use of accessories and cables other than those specified, with the exception of replacement parts sold by J. MORITA TOKYO MFG CORP. may result in increased emissions or decreased immunity of the MUX.
	Where possible this product should not be placed adjacent to other equipment, and should not be use with other equipment. If use with other equipment is required, only proceed after observing that the unit and other equipment work properly together.

EMISSION		
Emissions Test	Compliance	Environment
RF emission CISPR 11	Group 1 Class B	Professional healthcare facility environment
Harmonic distortion IEC61000-3-2	Class A	Professional healthcare facility environment
Voltage fluctuation and Flicker IEC 61000-3-3	Complies	Professional healthcare facility environment

<b>IMMUNITY</b>			
<b>Phenomenon</b>	<b>Basic EMC standard or test method</b>	<b>IMMUNITY TEST LEVELS</b>	<b>Environment</b>
Electrostatic Discharge (ESD)	IEC 61000-4-2	±8 kV contact ±2, ±4, ±8, ±15kV air	Professional healthcare facility environment
Radiated RF EM fields	IEC 61000-4-3	3 V/m 80 MHz-2.7 GHz 80% AM at 1kHz	Professional healthcare facility environment
Proximity fields from RF wireless communications equipment	IEC 61000-4-3	See Attachment 1	Professional healthcare facility environment
Electrical fast transient / burst	IEC 61000-4-4	±2.0 kV power supply 100 kHz repetition frequency	Professional healthcare facility environment
Surges Line-to-line	IEC 61000-4-5	±0.5, ±1 kV	Professional healthcare facility environment
Surges Line-to-ground	IEC 61000-4-5	±0.5, ±1, ±2kV	Professional healthcare facility environment
Conducted disturbances Induced by RF fields	IEC 61000-4-6	3V 0,5 MHz – 80 MHz 6V in ISM bands Between 0,15MHz and 80 MHz 80% AM at 1 kHz	Professional healthcare facility environment
RATED power frequency magnetic fields	IEC 61000-4-8	30 A/m 50 Hz or 60Hz	Professional healthcare facility environment
Voltage dips	IEC 61000-4-11	0% UT : 0.5 cycle At 0°, 45°, 90°, 135°, 180°, 225°, 270°and 315°	Professional healthcare facility environment
		0% UT: 1 cycle and 70% UT: 25/30 cycles Single phase: at 0°	Professional healthcare facility environment
Voltage interruptions	IEC 61000-4-11	0% UT: 250/300 cycle	Professional healthcare facility environment

Diagnostic and Imaging Equipment



Treatment Units



Handpieces and Instruments



Endodontic System



Laser Equipment



Laboratory Devices



Educational and Training Systems



Auxiliaries



MORITA

Sales Division

**J. MORITA CORP.**

Osaka Head Office 3-33-18, Tarumi-cho, Suita City, Osaka Japan 564-8650 Tel: +81. 6. 6380 2525  
Tokyo Head Office 2-11-15, Ueno Taito-ku, Tokyo Japan 110-8513 Tel: +81. 3. 3834 6161

Manufacturer

**J. MORITA TOKYO MFG. CORP.**

Main Factory Komuro 7129, Ina-machi, Kitaadachi-gun, Saitama Japan 362-0806 Tel: +81. 48. 723 2621

Morita Global Site: [www.morita.com](http://www.morita.com)

More Infos about Products: [www.dental-plaza.com](http://www.dental-plaza.com)

Please note that specifications and appearance may change without prior notice for product improvement purposes.

The company name and product names mentioned are trademarks, or registered trademarks of J. MORITA CORP. and J. MORITA TOKYO MFG. CORP.

As the color of the product is printed, it may differ from the actual color.

Some optional equipment is included.